



## D Series

### Operation Manual



**D-45**



**D-75A**

**Obtaining Other Language Versions:** To obtain information in another language about the use of this product, please contact your local Crown Distributor. If you need assistance locating your local distributor, please contact Crown at 574-294-8000.

This manual does not include all of the details of design, production, or variations of the equipment. Nor does it cover every possible situation which may arise during installation, operation or maintenance.

The information provided in this manual was deemed accurate as of the publication date. However, updates to this information may have occurred. To obtain the latest version of this manual, please visit the Crown website at [www.crownaudio.com](http://www.crownaudio.com).

**Trademark Notice:** Crown, Crown Audio, Amcron and IOC are registered trademarks of Crown International. Other trademarks are the property of their respective owners.

**Some models may be exported under the name Amcron.®**

## Important Safety Instructions

- 1) Read these instructions.
- 2) Keep these instructions.
- 3) Heed all warnings.
- 4) Follow all instructions.
- 5) Do not use this apparatus near water.
- 6) Clean only with a dry cloth.
- 7) Do not block any ventilation openings. Install in accordance with the manufacturer's instructions.
- 8) Do not install near any heat sources such as radiators, heat registers, stoves, or other apparatus (including amplifiers) that produce heat.
- 9) Do not defeat the safety purpose of the polarized or grounding-type plug. A polarized plug has two blades with one wider than the other. A grounding-type plug has two blades and a third grounding prong. The wide blade or the third prong is provided for your safety. If the provided plug does not fit into your outlet, consult an electrician for replacement of the obsolete outlet.
- 10) Protect the power cord from being walked on or pinched, particularly at plugs, convenience receptacles, and the point where they exit from the apparatus.
- 11) Only use attachments/accessories specified by the manufacturer.
- 12) Use only with a cart, stand, tripod, bracket, or table specified by the manufacturer, or sold with the apparatus. When a cart is used, use caution when moving the cart/apparatus combination to avoid injury from tip-over.
- 13) Unplug this apparatus during lightning storms or when unused for long periods of time.
- 14) Refer all servicing to qualified service personnel. Servicing is required when the apparatus has been damaged in any way, such as power-supply cord or plug is damaged, liquid has been spilled or objects have fallen into the apparatus, the apparatus has been exposed to rain or moisture, does not operate normally, or has been dropped.
- 15) **WARNING: TO REDUCE THE RISK OF FIRE OR ELECTRIC SHOCK, DO NOT EXPOSE THIS APPARATUS TO RAIN OR MOISTURE.**
- 16) **DO NOT EXPOSE TO DRIPPING OR SPLASHING. DO NOT PLACE OBJECTS FILLED WITH LIQUID, SUCH AS VASES, ON THIS APPARATUS.**



TO COMPLETELY DISCONNECT THIS EQUIPMENT FROM THE AC MAINS, DISCONNECT THE POWER SUPPLY CORD PLUG FROM THE AC RECEPTACLE. THE MAINS PLUG OF THE POWER SUPPLY CORD SHALL REMAIN READILY OPERABLE.

POUR DÉMONTÉ COMPLÈTEMENT L'ÉQUIPEMENT DE L'ALIMENTATION GÉNÉRALE, DÉMONTÉ LE CÂBLE D'ALIMENTATION DE SON RÉCEPTACLE. LA PRISE D'ALIMENTATION RESTERA AISÉMENT FONCTIONNELLE.

PARA DESCONECTAR COMPLETAMENTE EL EQUIPO DEL SUMINISTRO ELECTRICO, DESCONECTE EL CABLE DE ALIMENTACION DE LA TOMA DE CA. LAS PATAS DEL CONECTOR DEL CABLE DE ALIMENTACIÓN DEBERAN MANTENERSE EN BUEN ESTADO.

TO PREVENT ELECTRIC SHOCK DO NOT REMOVE TOP OR BOTTOM COVERS. NO USER SERVICEABLE PARTS INSIDE. REFER SERVICING TO QUALIFIED SERVICE PERSONNEL.

À PRÉVENIR LE CHOC ÉLECTRIQUE N'ENLEVEZ PAS LES COUVERTURES. IL N'Y A PAS DES PARTIES SERVICEABLE À L'INTÉRIEUR. TOUS REPARATIONS DOIT ÊTRE FAIRE PAR PERSONNEL QUALIFIÉ SEULMENT.

PARA PREVENIR UN CHOQUE ELÉCTRICO, NO RETIRE LAS CUBIERTAS SUPERIOR O INFERIOR. NO EXISTEN PARTES QUE PUEDAN SER REPARADAS POR EL USUARIO AL INTERIOR. REMITA EL SERVICICO AL PERSONAL TÉCNICAL CALIFICADO.

### WATCH FOR THESE SYMBOLS:

The lightning bolt triangle is used to alert the user to the risk of electric shock.

The exclamation point triangle is used to alert the user to important operating or maintenance instructions.

### REGARDEZ CES SYMBOLES

La triangle avec le sigle "foudre" est employée pour alerter l'utilisateur au risque de décharge électrique. Le triangle avec un point d'exclamation est employée pour alerter l'utilisateur d'instruction importantes pour lors opérations de maintenance.

### ATENCION CON ESTOS SÍMBOLOS

El triángulo con el símbolo de rayo eléctrico es usado para alertar al usuario de el riesgo de un choque eléctrico.

El triángulo con el signo de admiración es usado para alertar al usuario de instrucciones importantes de operación o mantenimiento.



**CAUTION**  
RISK OF ELECTRIC SHOCK  
DO NOT OPEN

**AVIS**  
RISQUE DE CHOC ÉLECTRIQUE  
N'OUVREZ PAS



### IMPORTANT

D Series amplifiers require Class 2 output wiring. Les amplificateurs de série de D exigent des câbles de sortie de classe 2. D-Reihe-Verstärker verlangen Klasse die 2 Produktionsverdrahtung. Los amplificadores de la Serie D requieren de un cableado de salida Clase 2.

### MAGNETIC FIELD

**CAUTION!** Do not locate sensitive high-gain equipment such as preamplifiers or tape decks directly above or below the unit. Because this amplifier has a high power density, it has a strong magnetic field which can induce hum into unshielded devices that are located nearby. The field is strongest just above and below the unit.

If an equipment rack is used, we recommend locating the amplifier(s) in the bottom of the rack and the preamplifier or other sensitive equipment at the top.

## FCC COMPLIANCE NOTICE

This device complies with part 15 of the FCC rules. Operation is subject to the following two conditions: (1) This device may not cause harmful interference, and (2) this device must accept any interference received, including interference that may cause undesired operation.

**CAUTION:** Changes or modifications not expressly approved by the party responsible for compliance could void the user's authority to operate the equipment.

**NOTE:** This equipment has been tested and found to comply with the limits for a Class B digital device, pursuant to part 15 of the FCC Rules. These limits are designed to provide reasonable protection against harmful interference in a residential installation. This equipment generates, uses, and can radiate radio frequency energy and, if not installed and used in accordance with the instruction manual, may cause harmful interference to radio communications. However, there is no guarantee that interference will not occur in a particular installation. If this equipment does cause harmful interference to radio or television reception, which can be determined by turning the equipment off and on, the user is encouraged to try to correct the interference by one or more of the following measures:

- Reorient or relocate the receiving antenna.
- Increase the separation between the equipment and receiver.
- Connect the equipment into an outlet on a circuit different from that to which the receiver is connected.
- Consult the dealer or an experienced radio/TV technician for help.

Crown International, Inc.

## DECLARATION of CONFORMITY

**Issued By:** Crown International, Inc.  
1718 W. Mishawaka Road  
Elkhart, Indiana 46517 U.S.A.

COMPLIANCE QUESTIONS ONLY: Sue Whitfield  
574-294-8289  
swhitfield@crowintl.com

**European Representative's Name and Address:**

Nick Owen  
35, Bassets Field  
Thornhill  
Cardiff, South Glamorgan  
CF14 9UG United Kingdom

**Equipment Type:** Commercial Audio Power Amplifiers

**Family Name:** D Family

**Model Names:** D-45, D-75A

**EMC Standards:**

**EN 55103-1:1997** Electromagnetic Compatibility - Product Family Standard for Audio, Video, Audio-Visual and Entertainment Lighting Control Apparatus for Professional Use, Part 1: Emissions

**EN 55103-1:1997** Magnetic Field Emissions-Annex A @ 10 cm and 20 cm

**EN 61000-3-2:2001** Limits for Harmonic Current Emissions (equipment input current less than or equal to 16 A per phase)

**EN 61000-3-3:2002** Limitation of Voltage Fluctuations and Flicker in Low-Voltage Supply Systems Rated Current less than or equal to 16A

**EN 55022:2003** Limits and Methods of Measurement of Radio Disturbance Characteristics of ITE: Radiated, Class B Limits; Conducted, Class A

**EN 55103-2:1997** Electromagnetic Compatibility - Product Family Standard for Audio, Video, Audio-Visual and Entertainment Lighting Control Apparatus for Professional Use, Part 2: Immunity

**EN 61000-4-2:2001** Electrostatic Discharge Immunity (Environment E2-Criteria B, 4k V Contact, 8k V Air Discharge)

**EN 61000-4-3:2001** Radiated, Radio-Frequency, Electromagnetic Immunity (Environment E2, criteria A)

**EN 61000-4-4:2001** Electrical Fast Transient/Burst Immunity (Criteria B)

**EN 61000-4-5:2001** Surge Immunity (Criteria B)

**EN 61000-4-6:2003** Immunity to Conducted Disturbances Induced by Radio-Frequency Fields (Criteria A)

**EN 61000-4-11:2001** Voltage Dips, Short Interruptions and Voltage Variation

**Safety Standard:**

**IEC 60065: 2001** 7th Ed. Safety Requirements - Audio Video and Similar Electronic Apparatus

I certify that the product identified above conforms to the requirements of the EMC Council Directive 89/336/EEC as amended by 92/31/EEC, and the Low Voltage Directive 73/23/EES as amended by 93/68/EEC.

Signed

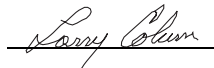

Larry Coburn  
Title: Senior Vice President of Manufacturing

Date of Issue: Jan. 1, 2006

## Table of Contents

Important Safety Instructions .....	2	3.4 Controls .....	12
Declaration of Conformity .....	3	3.5 Fuse Replacement .....	12
<b>1 Welcome .....</b>	<b>5</b>	<b>4 Advanced Features and Options .....</b>	<b>13</b>
1.1 Features .....	5	4.1 Protection .....	13
1.2 How to Use This Manual .....	5	4.2 Options .....	13
<b>2 Setup .....</b>	<b>6</b>	4.2.1 Bridge-Mono Option .....	13
2.1 Unpack Your Amplifier.....	6	4.2.2 Input-Sensitivity Option .....	13
2.2 Install Your Amplifier .....	6	<b>5 Troubleshooting .....</b>	<b>14</b>
2.3 Ensure Proper Cooling .....	6	<b>6 Specifications .....</b>	<b>15</b>
2.4 Choose Input Wire and Connectors .....	7	<b>7 Service .....</b>	<b>17</b>
2.5 Choose Output Wire and Connectors .....	7	7.1 International and Canada Service .....	17
2.6 Wire Your System .....	8	7.2 US Service .....	17
2.6.1 Dual Mode .....	8	7.2.1 Service at a US Service Center .....	17
2.6.2 Bridge-Mono Mode .....	8	7.2.2 Factory Service .....	17
2.7 Connect to AC Mains .....	9	7.2.3 Factory Service Shipping Instructions .....	17
2.7.1 AC Mains Voltage Configuration .....	9	7.2.4 Packing Instructions.....	17
2.8 Startup Procedure .....	9	7.2.5 Estimate Approval.....	17
<b>3 Operation .....</b>	<b>10</b>	7.2.6 Payment of Non-Warranty Repairs.....	17
3.1 Precautions .....	10	<b>8 Warranty .....</b>	<b>18</b>
3.2 Controls, Indicators and Connectors .....	11	Product Registration.....	21
3.3 Indicators .....	12	Crown Factory Service Information Form .....	23

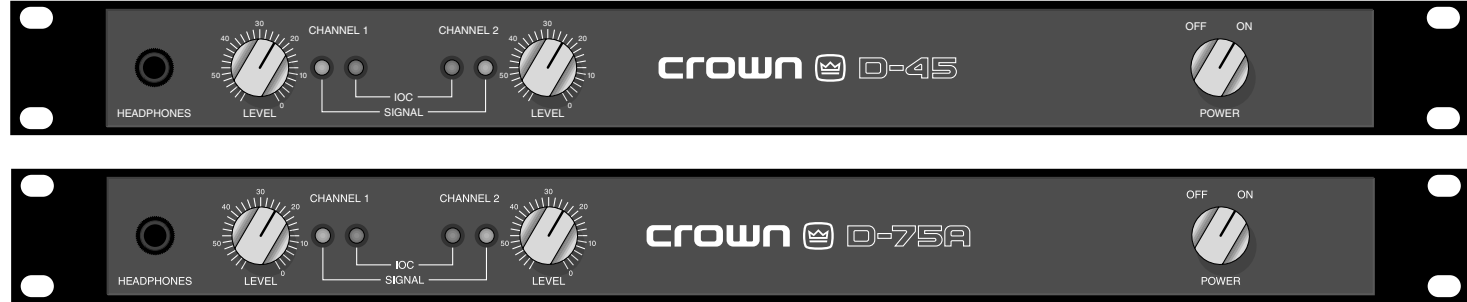

<b>D - 45</b>	*1 kHz Power
4-ohm Dual (per channel)	<b>35W</b>
8-ohm Dual (per channel)	<b>25W</b>
16-ohm Dual (per channel)	<b>20W</b>
8-ohm Bridge-Mono	<b>70W</b>
16-ohm Bridge-Mono	<b>50W</b>
*1 kHz Power: refers to maximum average power in watts at 1 kHz with 0.1% THD.	

<b>D - 75A</b>	*1 kHz Power
4-ohm Dual (per channel)	<b>55W</b>
8-ohm Dual (per channel)	<b>40W</b>
16-ohm Dual (per channel)	<b>25W</b>
8-ohm Bridge-Mono	<b>110W</b>
16-ohm Bridge-Mono	<b>80W</b>
*1 kHz Power: refers to maximum average power in watts at 1 kHz with 0.1% THD.	

## 1 Welcome

Reliability is the first thing you get with your purchase of a Crown® power amplifier. The D-45 and D-75A both deliver dependable operation with a wide variety of loads. Because of their exceptional reliability, these amplifiers have become the leading choice of professionals for use in recording studios, laboratories and public facilities. You can even find them on the road. Their sonic excellence also makes them a very good choice for your personal listening pleasure.

The D-45 and D-75A amplifiers are compact and provide ultra-low distortion for medium power applications. Crown's advanced AB+B circuitry ensures efficient operation and protects against shorted, open, mismatched or low-impedance loads that can affect any amplifier's performance.

Modern power amplifiers are sophisticated pieces of engineering capable of producing extremely high power levels. They must be treated with respect and correctly installed if they are to provide the many years of reliable service for which they were designed.

In addition, D Series amplifiers include a number of features which require some explanation before they can be used to their maximum advantage.

Please take the time to study this manual so that you can obtain the best possible service from your amplifier.

### 1.1 Features

Your dual-channel (stereo) amplifier can optionally be configured to deliver double the power from a single (mono) channel. It also provides the following features:

- Powerful AB+B class circuitry yields maximum efficiency with minimum crossover "notch" distortion.
- *IOC*® (Input/Output Comparator) alerts of any distortion that exceeds 0.05% to provide proof of distortion-free performance.
- Signal presence indicators verify the presence of amplifier output.
- Detented level controls for precise repeatability.
- Ultra-low harmonic and intermodulation distortion result in the best dynamic transfer function in the industry.
- Very low noise and wide dynamic range.
- High damping factor provides exceptional loudspeaker motion control.
- Convection cooling system eliminates fan noise and maintenance.

- Mounts in a standard 19-inch (48.3-cm) rack.
- Front-panel headphone jack.
- Three Year, No-Fault, Fully-Transferable Warranty completely protects your investment and guarantees its specifications.

### 1.2 How to Use This Manual

This manual provides you with the necessary information to safely and correctly setup and operate your amplifier. It does not cover every aspect of installation, setup or operation that might occur under every condition. For additional information, please consult Crown's *Amplifier Application Guide* (available online at [www.crownaudio.com](http://www.crownaudio.com)), Crown Technical Support, your system installer or retailer.

We strongly recommend you read all instructions, warnings and cautions contained in this manual. Also, for your protection, please send in your warranty registration card today. And save your bill of sale — it's your official proof of purchase.

## 2 Setup

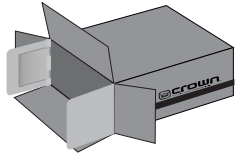

### 2.1 Unpack Your Amplifier

Please unpack and inspect your amplifier for any damage that may have occurred during transit. If damage is found, notify the transportation company immediately. Only you can initiate a claim for shipping damage. Crown will be happy to help as needed. Save the shipping carton as evidence of damage for the shipper's inspection.

We also recommend that you save all packing materials so you will have them if you ever need to transport the unit. **Never ship the unit without the factory pack.**

YOU WILL NEED (not supplied):

- Input wiring cables
- Output wiring cables

Rack for mounting amplifier (or a stable surface for stacking)



**WARNING:** Before you start to set up your amplifier, make sure you read and observe the Important Safety Instructions found at the beginning of this manual.

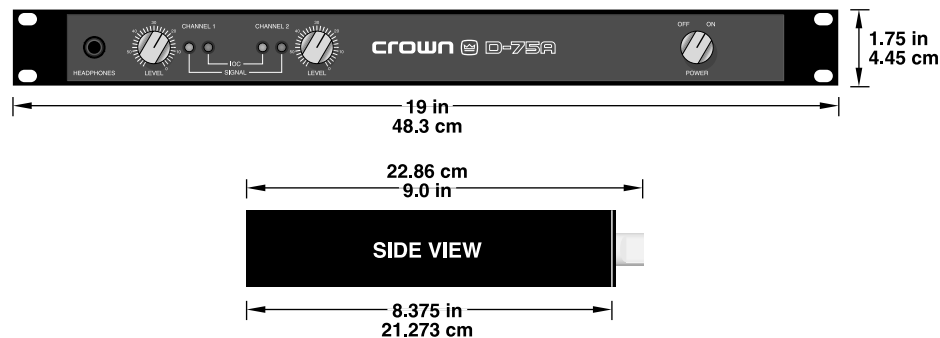

Figure 2.1 D-45 and D-75A Dimensions



### 2.2 Install Your Amplifier

**CAUTION:** Before you begin, make sure your amplifier is disconnected from the power source, with the power switch in the "off" position and all level controls turned completely down (counterclockwise).

Use a standard 19-inch (48.3 cm) equipment rack (EIA RS-310B). See Figure 2.1 for amplifier dimensions.

You may also stack amps without using a cabinet.

NOTE: When transporting, amplifiers should be supported at the front.

### 2.3 Ensure Proper Cooling

When using an equipment rack, do not mount units directly on top of each other. Allow some air space between units for convection cooling. The side walls of the rack should be a minimum of two inches (5.1 cm) away from the amplifier sides, and the back of the rack should be a minimum of four inches (10.2 cm) from the amplifier back panel.

Figure 2.2 illustrates D Series amplifier installation.

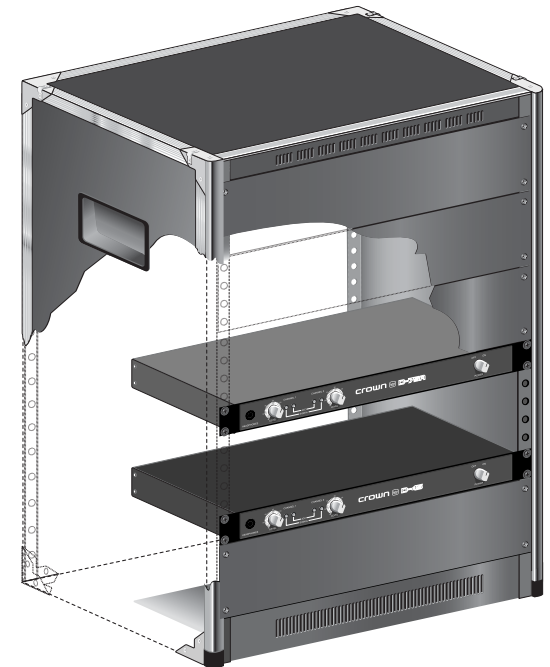

Figure 2.2 Installation

## 2 Setup

### 2.4 Choose Input Wire and Connectors

Figure 2.3 shows connector pin assignments for balanced wiring, and Figure 2.4 shows connector pin assignments for unbalanced wiring.



**NOTE: Custom wiring should only be performed by qualified personnel.**

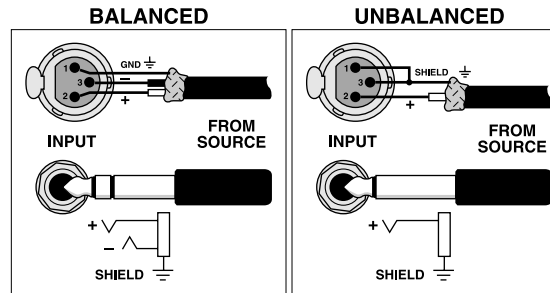

Figure 2.3 Balanced Input Connector Wiring

Figure 2.4 Unbalanced Input Connector Wiring

### 2.5 Choose Output Wire and Connectors

Crown recommends using professionally constructed, high-quality, two- or four-conductor, heavy gauge speaker wire and connectors. You may use terminal forks or bare wire for your output connectors (see Figure 2.5). To prevent the possibility of short-circuits, wrap or otherwise insulate exposed loudspeaker cable and connectors.

Using the guidelines below, select the appropriate size of wire based on the distance from amplifier to speaker.

Distance	Wire Size
up to 25 ft.	16 AWG
26-40 ft.	14 AWG
41-60 ft.	12 AWG
Over 60 ft.	10 AWG



**CAUTION: Never use shielded cable for output wiring.**

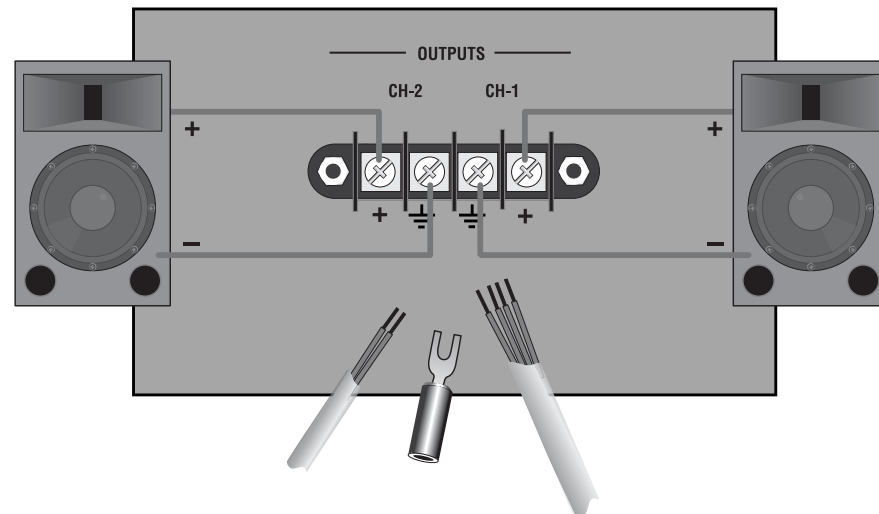

Figure 2.5 Output Connector Wiring

## 2 Setup

### 2.6 Wire Your System

#### 2.6.1 Dual Mode

Typical input and output wiring is shown in Figure 2.5.

INPUTS: Connect input wiring for each channel.

OUTPUTS: Maintain proper polarity (+/-) on output connectors.

Connect Channel 1 positive (+) speaker load to Channel 1 positive terminal of amp; repeat for negative (-). Repeat each channel wiring as for Channel 1. Refer to Section 2.5 for output connector pin assignments.

#### 2.6.2 Bridge-Mono Mode

Your amplifier is factory-configured for dual (stereo) operation. As an option, the unit can be configured for higher power, single-channel, bridge-mono mode by an authorized Crown Service Center. **To prevent damage to the amplifier, do not operate the unit in bridge-mono mode without the Service Center modification.**

Typical input and output wiring is shown in Figure 2.7.

INPUTS: Connect input wiring only to CH 1.

OUTPUTS: Connect the speaker across the positive output terminals. Do not use the negative terminals when the amplifier is being operated in Bridge-Mono mode.

NOTE: Crown provides a reference of wiring pin assignments for commonly used connector types in the Crown Amplifier Application Guide available at [www.crownaudio.com](http://www.crownaudio.com).

**NOTE: When operating in Bridge-Mono mode, turn down (full CCW) the CH 2 level control. The CH 1 level control works both channels.**

If your loudspeakers don't need the additional voltage, and you only have one input signal to drive multiple loudspeakers, you can use bridge-mono mode without actually bridging the outputs. Bridge-mono mode is like dual mode except the channel 1 input feeds both outputs, and the channel 2 output is inverted. To use bridge-mono mode without bridging the outputs, wire your loudspeakers as you would for dual mode, but invert the polarity of the channel 2 output wiring (positive goes to negative, and negative goes to positive).

Figure 2.6 System Wiring for Dual Mode

### DUAL MODE

FROM THE FACTORY, YOUR AMPLIFIER IS CONFIGURED FOR DUAL OPERATION

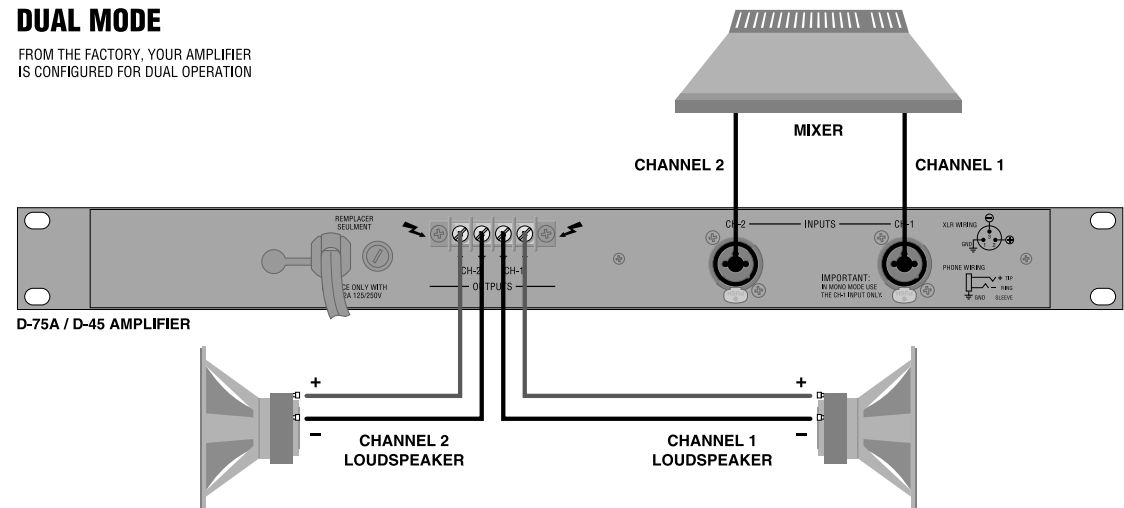

### BRIDGE-MONO MODE

**Do not wire the amplifier in bridge-mono mode without having it modified by an authorized Crown Service Center.**

Figure 2.7 System Wiring for Bridge-Mono Mode

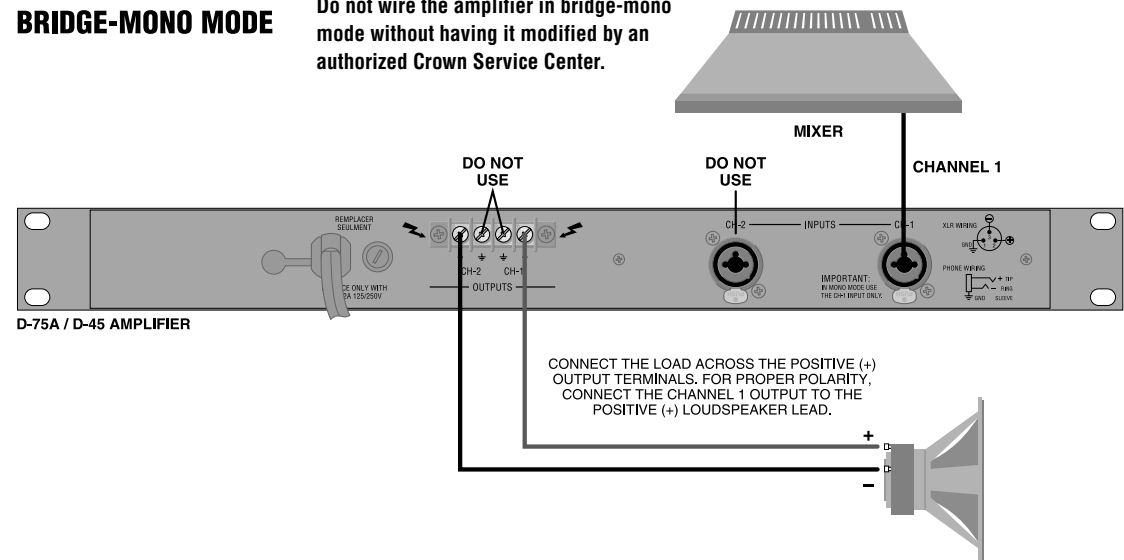

## 2 Setup



### 2.7 Connect to AC Mains

Connect your amplifier to the AC mains power source (power outlet) with the supplied AC power cordset.

**WARNING: The third prong of this connector (ground) is an important safety feature. Do not attempt to disable this ground connection by using an adapter or other methods.**

Amplifiers don't create energy. The AC mains voltage and current must be sufficient to deliver the power you expect. You must operate your amplifier from an AC mains power source with not more than a 10% variation above or a 15% variation below the amplifier's specified line voltage and within the specified frequency requirements (indicated on the amplifier's back panel label). If you are unsure of the output voltage of your AC mains, please consult your electrician.

#### 2.7.1 AC Mains Voltage Configuration

North American 120 VAC, 60 Hz units have a standard three wire, grounded AC plug as specified by UL requirements. The 120 volt models and the European models have the appropriate plug. The other 200, 220 and 240 volt models have a North American 120 volt plug. The installer must cut off the plug and supply and install a plug appropriate for the installation. Note: Crown assumes no liability whatsoever for ungrounded operation, nor for violation of UL or local electrical codes.

120 VAC, 60 Hz North American units do not have a convertible transformer, and cannot be

used at other voltages and frequencies. International units can be operated with an AC mains frequency of 50 to 400 Hz, and can be configured by an authorized Crown Service Center for five different line voltages: 100, 120, 200, 220 and 240 VAC. The back panel sticker indicates the unit's factory configuration.

To alter your amplifier's AC mains voltage configuration, take the unit to an authorized Crown Service Center.

### 2.8 Startup Procedure

Use the following procedure when first turning on your amplifier:

1. Turn down the level of your audio source.
2. Turn down the Level controls of the amplifier.
3. Turn on the "Power" switch. The Power indicator should glow.
4. Turn up the level of your audio source to an optimum level.
5. Turn up the Level controls on the amplifier until the desired loudness or power level is achieved.
6. Turn down the level of your audio source to its normal range.

If you ever need to make any wiring or installation changes, don't forget to disconnect the power cord.

For help with determining your system's optimum gain structure (signal levels) please refer to the Crown *Amplifier Application Guide*, available online at [www.crownaudio.com](http://www.crownaudio.com).

## 3 Operation

### 3.1 Precautions

Your amplifier is protected from internal and external faults, but you should still take the following precautions for optimum performance and safety:

1. Before use, your amplifier first must be configured for proper operation, including input and output wiring hookup. Improper wiring can result in serious operating difficulties. For information on wiring and configuration, please consult the Setup section of this manual or, for advanced setup techniques, consult Crown's *Amplifier Application Guide* available online at [www.crownaudio.com](http://www.crownaudio.com).
2. Use care when making connections, selecting signal sources and controlling the output level. The load you save may be your own!
3. Do not short the ground lead of an output cable to the input signal ground. This may form a ground loop and cause oscillations.
4. **IMPORTANT: Headphone jack supplies full output voltage. Always turn level down (full CCW) before listening through headphones; otherwise headphone or hearing damage may result.**



5. **WARNING: Never connect the output to a power supply, battery or power main. Electrical shock may result.**



6. Tampering with the circuitry, or making unauthorized circuit changes may be hazardous and invalidates all agency listings.
7. Do not operate the amplifier with the IOC LEDs constantly flashing.
8. Do not overdrive the mixer, which will cause clipped signal to be sent to the amplifier. Such signals will be reproduced with extreme accuracy, and loudspeaker damage may result.
9. Do not operate the amplifier with less than the rated load impedance. Due to the amplifier's output protection, such a configuration may result in premature clipping and speaker damage.

*Remember: Crown is not liable for damage that results from overdriving other system components.*

### 3 Operation

#### 3.2 Controls, Indicators and Connectors

Figure 3.1 shows the controls, indicators and connectors on the front panel and back panel of the D-75A. The D-45 layout is similar.

**WARNING: HEADPHONE JACK SUPPLIES FULL OUTPUT POWER AND MAY DAMAGE HEADPHONES OR CAUSE HEARING DAMAGE.**

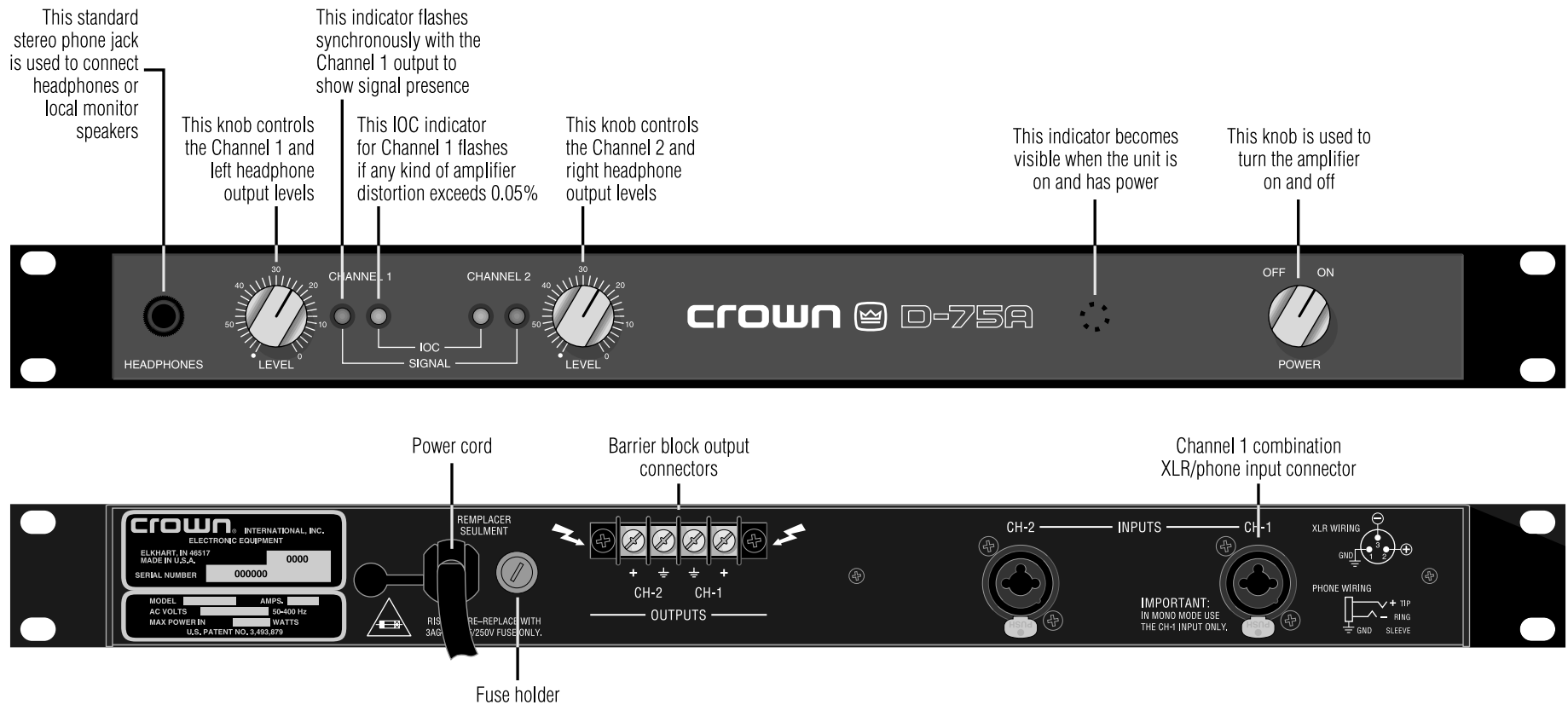

Figure 3.1 Front and Back Views

## 3 Operation

### 3.3 Indicators

Your amplifier has five front panel indicators. First, a power indicator behind the front panel becomes visible when the unit is turned on and has power. A signal indicator for each channel (Figure 3.2) flashes when there is output from the amplifier. The IOC (Input/Output Comparator) indicators work like sensitive distortion meters and flash when the amplifier causes any distortion of 0.05% or more. The IOC indicators typically glow for about one minute after the AC power is turned off.

### 3.4 Controls

A power switch and detented level controls are located on the front panel. When you power up the amplifier, remember that the unit does not have a turn-on delay. Each channel has its own level control which is used to adjust the desired output level. Both level controls (Figure 3.2) are used in dual mode, but only the channel 1 control should be used in bridge-mono mode. Channel 2 control should be fully counter-clockwise in bridge-mono mode.

### 3.5 Fuse Replacement

The AC mains fuse is located on the back panel beside the power cord. This fuse will not blow unless something is wrong. Before replacing



**WARNING: Always unplug the amplifier from the AC mains before removing the fuse.**

To replace the fuse, turn off the power switch and disconnect the power plug from the AC mains. Unscrew the fuse holder cap (shown in Figure 3.1, back view) and remove the fuse.

Install appropriate fuse:

100 or 120 volt mains: 2 Amp type 3AG.

North American 200, 220 and 240 volt mains: 1 Amp type 3AG.

European 220 or 240 volt mains: 1 Amp IEC type T, time lag, low breaking capacity.

Then, simply resecure the fuse holder cap and reconnect the AC mains.



**IMPORTANT: Never install a fuse that has a higher current rating than the recommended value.**



**IMPORTANT: The 3AG and IEC fuses are different physical sizes and require different holder caps. The 3AG and IEC fuses should not be exchanged even though they are the same value.**

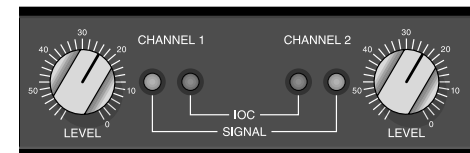

*Figure 3.2  
Indicators and Level  
Controls*

## 4 Advanced Features and Options

**NOTE:** For detailed information about these Crown amplifier features, please consult the *Crown Amplifier Application Guide*, available on the Crown website at [www.crownaudio.com](http://www.crownaudio.com).

### 4.1 Protection

Your amplifier is protected against all common hazards that plague high-power amplifiers, including shorted, open or mismatched loads; overloaded power supplies, chain destruction phenomena, input overload and high-frequency blowups.

Protection against shorted and mismatched loads is provided by an instantaneous limiter that automatically limits current to the maximum safe value for the output transistors. With a loudspeaker, you can tell the amplifier has activated load protection because it causes audible distortion. The noise might be compared to crossover notch distortion or a snapping sound, depending on the load characteristics. Loudspeaker systems with impedances of 4 ohms or higher should not activate the protection system.

All voltage amplification circuitry is designed to limit current. So in the extremely unlikely event of a device failure, the amplifier will prevent further damage. The input stages are protected from overload damage by series resistors. The unit also features a controlled slew rate and a V-I limiter that protect the amplifier from high-frequency (RF) blowups.

### 4.2 Options

#### 4.2.1 Bridge-Mono Option

Your amplifier is factory-set for dual (stereo) operation. As an option, you may have the unit configured for higher-power, single-channel, bridge-mono operation. If you want the bridge-mono modification, take the unit to an authorized Crown Service Center.

**IMPORTANT: Critical differences between dual and mono wiring are described in Section 2.6.2.**

#### 4.2.2 Input-Sensitivity Option

The input sensitivity of your amplifier is factory-set to 26 dB gain. As an option, the unit can be set to an input sensitivity of 0.775 volt by an authorized Crown Service center.

For most applications, the amplifier's default setting of 26 dB gain will be ideal. With this default setting, full output power is achieved with an input signal of 0.632 volts for the D-45, and 0.837 volts for the D-75A.

Some applications may require the gain structure to be calculated based on a sensitivity of 0.775 volts. And although the 26 dB gain setting provides a sensitivity for each amplifier that is very near 0.775 volts, the 0.775-volt sensitivity setting is provided for applications that demand this sensitivity with a high level of precision.

A Crown Service Center can activate the 0.775 volt input sensitivity without voiding the warranty.

## 5 Troubleshooting

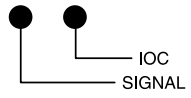

**CONDITION: Power indicator is off.**

**POSSIBLE REASON**

- The amplifier has lost AC power.
- The amplifier's Power switch is off.
- The amplifier is not plugged into the power receptacle.
- The amplifier output level is so high that the power supply fuse has blown. Verify that input levels and output impedances are within safe ranges. Refer the unit to an authorized Crown service center for fuse replacement.

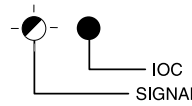

**CONDITION: No sound, even though the amp has power.** Power LED is on and the amp is receiving an input signal. Signal indicator is flashing.

**POSSIBLE REASON:**

- Speakers not connected.
- Open circuit due to speaker failure.

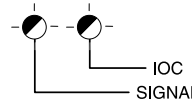

- There is a short on the amplifier output. First disconnect your speakers from the affected channel(s) one by one to determine if one of the loads is shorted.

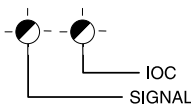

**CONDITION: Distorted sound.**

**POSSIBLE REASON:**

- Load is wired incorrectly.
- Input signal level is too high. Turn down your amplifier level controls, or turn down the input signal, until the clip light goes out.

Note: If the signal sounds distorted even though the Clip LED is off, the input signal is distorted. Check gain staging and output levels of the mixer or preamp.

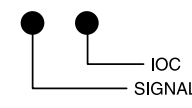

**CONDITION: No input signal.** (Signal indicator is not flashing even though audio is applied).

**POSSIBLE REASON:**

- Input signal level is very low.
- Level controls are turned down.

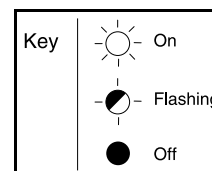

## 6 Specifications

<b>Minimum Guaranteed Power</b>	<b>D-45</b>	<b>D-75A</b>
120V/60 Hz Units, Dual mode, per channel, both channels driven		
1 kHz with 0.1% THD		
4 ohms	35W	55W
8 ohms	25W	40W
16 ohms	20W	25W
120V/60 Hz Units, Bridge mono mode		
1 kHz with 0.1% THD		
8 ohms	70W	110W
16 ohms	50W	80W
<b>Performance</b>	<b>D-45</b>	<b>D-75A</b>
Frequency Response (at 1 watt, 20Hz - 20 kHz)	± 0.1 dB	± 0.1 dB
Phase Response (at 1 watt, 20Hz - 20 kHz)	+10° to -15°	+10° to -15°
Signal to Noise Ratio (below rated power, 20 Hz to 20 kHz)	106 dB unweighted	106 dB unweighted
Total Harmonic Distortion (THD) at 1 watt, from 20 Hz to 20 kHz	< 0.05%	< 0.05%
Intermodulation Distortion (IMD) 60 Hz and 7 kHz at 4:1, from .25 watts to full bandwidth power	< 0.01%	< 0.01%
Damping Factor: DC to 400 Hz	> 400	> 400
Crosstalk (below rated power, 100 Hz to 1 kHz)	>100 dB	> 100 dB
Input Impedance nominally balanced, nominally unbalanced	20 kilohms, 10 kilohms	20 kilohms, 10 kilohms
Load Impedance (Note: Safe with all types of loads)		
Stereo	4-16 ohms	4-16 ohms
Bridge Mono	8-16 ohms	8-16 ohms
Required AC Mains		
North American units	120 VAC, 60 Hz	120 VAC, 60 Hz
International units	100, 120, 200, 220, and 240 VAC (± 10%), 50 to 400 Hz depending on the transformer configuration	100, 120, 200, 220, and 240 VAC (± 10%), 50 to 400 Hz depending on the transformer configuration
Power Draw at Idle	15 W or less	15 W or less
Cooling	Convection cooled through chassis and front panel	Convection cooled through chassis and front panel
Dimensions: Width, Height, Depth	19 in. (48.3 cm) x 1.75 in. (4.5 cm) x 8.5 in. (21.6 cm)	19 in. (48.3 cm) x 1.75 in. (4.5 cm) x 8.5 in. (21.6 cm)
Net Weight, Shipping Weight	8 lb. 11 oz. (3.9 kg), 10 lb. 9 oz. (4.8 kg)	9 lb. 7 oz. (4.3 kg), 11 lb. 4 oz. (5.1 kg)

## 6 Specifications

<b>D-45</b>											
Configuration and Load (ohms)		FTC Continuous Average Power at 0.1% THD (See note 1)		Max. Average Power at 0.1% THD (See note 2)	Single-Cycle Tone Burst Watts at < 0.05% THD (See note 3)			40 mS Tone Burst Watts at < 0.05% THD (See note 4)			EIA Watts at 1% THD (See note 5)
		20Hz-20kHz	1 kHz	1 kHz	20 Hz	50 Hz	1 kHz	20 Hz	50 Hz	1 kHz	1 kHz
Dual (both channels driven)	4			35	40	50	75	55	60	60	35
	8	20	25	25	25	30	35	40	40	40	25
	16	20	20	20	20	20	20	20	20	20	20
Bridge-Mono (balanced output)	8			70	85	105	145	85	85	85	70
	16	40	50	50	50	60	70	50	50	55	50

Figure 6.1 D-45 Power Matrix

<b>D-75A</b>											
Configuration and Load (ohms)		FTC Continuous Average Power at 0.1% THD (See note 1)		Max. Average Power at 0.1% THD (See note 2)	Single-Cycle Tone Burst Watts at < 0.05% THD (See note 3)			40 mS Tone Burst Watts at < 0.05% THD (See note 4)			EIA Watts at 1% THD (See note 5)
		20Hz-20kHz	1 kHz	1 kHz	20 Hz	50 Hz	1 kHz	20 Hz	50 Hz	1 kHz	1 kHz
Dual (both channels driven)	4	45	50	55	65	85	120	65	70	70	55
	8	35	40	40	45	50	60	45	45	45	40
	16	25	25	25	25	30	30	25	25	25	25
Bridge-Mono (balanced output)	8	95	105	110	140	165	235	140	140	140	105
	16	70	75	80	90	100	130	90	90	95	75

Figure 6.2 D-75A Power Matrix

### Notes:

All power matrix specifications are based on a 0.1% regulated 120 VAC, 60 Hz power mains and an ambient room temperature of 70° F (21° C).

1. Continuous power in the context of Federal Trade Commission testing is understood to be a minimum of five minutes of operation. Harmonic distortion is measured at the RMS sum total as a percentage of the fundamental output voltage. This applies for all wattages greater than 0.25 watts.
2. A 1 kHz sine wave is presented to the amplifier and the output monitored for nonlinear distortion. The level is increased until the THD reaches 0.1%. At this level the average power per channel is reported.
3. A single cycle sine wave is presented to the amplifier and monitored for nonlinear distortion. The average power during the burst is reported. Loudspeakers must be able to withstand this level if they are to be safely used with this amplifier.
4. A 40 millisecond burst or a two cycle sine wave (whichever is of greater duration) is used and the power computed as the average power during the burst. The duty cycle of this test is 10 percent. This power level is a measure of how loud an amplifier is as perceived by the human ear.
5. EIA standard RS-490 (both channels driven).

## 7 Service

Crown amplifiers are quality units that rarely require servicing. Before returning your unit for service, please contact Crown Technical Support to verify the need for servicing.

This unit has very sophisticated circuitry which should only be serviced by a fully trained technician. This is one reason why each unit bears the following label:

**CAUTION: To prevent electric shock, do not remove covers. No user serviceable parts inside. Refer servicing to a qualified technician.**



Complete the Crown Audio Factory Service Information form, in the back of this manual, when returning a Crown product to the factory or authorized service center. The form must be included with your product inside the box or in a packing slip envelope securely attached to the outside of the shipping carton. Do not send this form separately.

*Warranty is only valid within the country in which the product is purchased.*

### 7.1 International and Canada Service

Service may be obtained from an authorized service center. (Contact your local Crown/Amcron representative or our office for a list of authorized service centers.) To obtain service, simply present the bill of sale as proof of purchase along with the defective unit to an authorized service center. They will handle the necessary paperwork and repair.

Remember to transport your unit in the original factory pack.

### 7.2 US Service

Service may be obtained in one of two ways: from an authorized service center or from the factory. You may choose either. It is important that you have your copy of the bill of sale as your proof of purchase.

#### 7.2.1 Service at a US Service Center

This method usually saves the most time and effort. Simply present your bill of sale along with the defective unit to an authorized service center to obtain service. They will handle the necessary paperwork and repair. Remem-

ber to transport the unit in the original factory pack. A list of authorized service centers in your area can be obtained from Crown Factory Service, or online from <http://www.crownaudio.com/support/servcent.htm>.

#### 7.2.2 Factory Service

Crown accepts no responsibility for non-serviceable product that is sent to us for factory repair. It is the owner's responsibility to ensure that their product is serviceable prior to sending it to the factory. Serviceable product list is available at <http://crownweb.crownintl.com/crownrma/>. For more information, please contact us direct.

A Service Return Authorization (SRA) is required for product being sent to the factory for repair. An SRA can be completed online at [www.crownaudio.com/support/factserv.htm](http://www.crownaudio.com/support/factserv.htm). If you do not have access to the web, please call Crown's Customer Service at 574.294.8200 or 800.342.6939 extension 8205.

For warranty service, we will pay for ground shipping both ways in the United States. Contact Crown Customer Service to obtain prepaid shipping labels prior to sending the unit. Or, if you prefer, you may prepay the cost of shipping, and Crown will reimburse you. Send copies of the shipping receipts to Crown to receive reimbursement. Your repaired unit will be returned via UPS ground. Please contact us if other arrangements are required.

#### 7.2.3 Factory Service Shipping Instructions:

1. Service Return Authorization (SRA) is required for product being sent to the factory for service. Please complete the SRA by going to [www.crownaudio.com/support/factserv.htm](http://www.crownaudio.com/support/factserv.htm). If you do not have access to our website, call 1.800.342.6939, extension 8205 and we'll create the SRA for you.
2. See packing instructions that follow.
3. Ship product to:  
CROWN AUDIO FACTORY SERVICE  
1718 W MISHAWKA RD.  
ELKHART, IN 46517
4. Use a bold black marker and write the SRA number on three sides of the box.

5. Record the SRA number for future reference. The SRA number can be used to check the repair status.

#### 7.2.4 Packing Instructions

**Important:** These instructions must be followed. If they are not followed, Crown Audio, Inc. assumes no responsibility for damaged goods and/or accessories that are sent with your unit.

1. Fill out and include the Crown Audio Factory Service Information sheet in the back of this manual.
2. Do not ship any accessories (manuals, cords, hardware, etc.) with your unit. These items are not needed to service your product. We will not be responsible for these items.
3. When shipping your Crown product, it is important that it has adequate protection. We recommend you use the original pack material when returning the product for repair. If you do not have the original box, please call Crown at 800.342.6939 or 574.294.8210 and order new pack material. See instructions for "foam-in-place" shipping pack. (Do not ship your unit in a wood or metal cabinet.)
4. If you provide your own shipping pack, the minimum recommended requirements for materials are as follows:
  - a. 275 P.S.I. burst test, Double-Wall carton that allows for 2-inch solid Styrofoam on all six sides of unit or 3 inches of plastic bubble wrap on all six sides of unit.
  - b. Securely seal the package with an adequate carton sealing tape.
  - c. Do not use light boxes or "peanuts". Damage caused by poor packaging will not be covered under warranty.

#### Using your 'foam-in-place' shipping pack

Note: The foam-in-place packing is molded so that there is only one correct position for your product.

1. Open carton and lift center cushion leaving both end-cushions in place.

2. Carefully place your product with the product's front panel facing the same direction as arrows indicate.
3. Reset center cushion down over top of product's chassis. The foam-in-place packing was molded to accommodate different chassis depth sizes. If your product's chassis does not completely fill the foam-in-place cavity, you may use a soft but solid packing material (such as paper or bubble wrap) behind the chassis.
4. Enclose the completed Crown Audio Factory Service Information form (or securely attach it to the outside of carton) and re-seal the shipping pack with a sturdy carton sealing tape.

#### 7.2.5 Estimate Approval

Approval of estimate must be given within 30 days after being notified by Crown Audio Inc. Units still in the possession of Crown after 30 days of the estimate will become the property of Crown Audio Inc.

#### 7.2.6 Payment of Non-Warranty Repairs

Payment on out-of-warranty repairs must be received within 30 days of the repair date. Units unclaimed after 30 days become the property of Crown Audio Inc.

If you have any questions, please contact Crown Factory Service.

**Crown Factory Service**  
1718 W. Mishawaka Rd.,  
Elkhart, Indiana 46517 U.S.A.

**Telephone:**  
574.294.8200  
800.342.6939 (North America,  
Puerto Rico, and Virgin Islands only)

**Facsimile:**  
574.294.8301 (Technical Support)  
574.294.8124 (Factory Service)

**Internet:**  
<http://www.crownaudio.com>

## 8 Warranty



### UNITED STATES & CANADA

#### SUMMARY OF WARRANTY

Crown International, 1718 West Mishawaka Road, Elkhart, Indiana 46517-4095 U.S.A. warrants to you, the ORIGINAL PURCHASER and ANY SUBSEQUENT OWNER of each NEW Crown product, for a period of three (3) years from the date of purchase by the original purchaser (the "warranty period") that the new Crown product is free of defects in materials and workmanship. We further warrant the new Crown product regardless of the reason for failure, except as excluded in this Warranty.

*Warranty is only valid within the country in which the product was purchased.*

#### ITEMS EXCLUDED FROM THIS CROWN WARRANTY

This Crown Warranty is in effect only for failure of a new Crown product which occurred within the Warranty Period. It does not cover any product which has been damaged because of any intentional misuse, accident, negligence, or loss which is covered under any of your insurance contracts. This Crown Warranty also does not extend to the new Crown product if the serial number has been defaced, altered, or removed.

#### WHAT THE WARRANTOR WILL DO

We will remedy any defect, regardless of the reason for failure (except as excluded), by repair, replacement, or refund. We may not elect refund unless you agree, or unless we are unable to provide replacement, and repair is not practical or cannot be timely made. If a refund is elected, then you must make the defective or malfunctioning product available to us free and clear of all liens or other encumbrances. The refund will be equal

to the actual purchase price, not including interest, insurance, closing costs, and other finance charges less a reasonable depreciation on the product from the date of original purchase. Warranty work can only be performed at our authorized service centers or at the factory. Warranty work for some products can only be performed at our factory. We will remedy the defect and ship the product from the service center or our factory within a reasonable time after receipt of the defective product at our authorized service center or our factory. All expenses in remedying the defect, including surface shipping costs in the United States, will be borne by us. (You must bear the expense of shipping the product between any foreign country and the port of entry in the United States including the return shipment, and all taxes, duties, and other customs fees for such foreign shipments.)

#### HOW TO OBTAIN WARRANTY SERVICE

You must notify us of your need for warranty service within the warranty period. All components must be shipped in a factory pack, which, if needed, may be obtained from us free of charge. Corrective action will be taken within a reasonable time of the date of receipt of the defective product by us or our authorized service center. If the repairs made by us or our authorized service center are not satisfactory, notify us or our authorized service center immediately.

#### DISCLAIMER OF CONSEQUENTIAL AND INCIDENTAL DAMAGES

YOU ARE NOT ENTITLED TO RECOVER FROM US ANY INCIDENTAL DAMAGES RESULTING FROM ANY DEFECT IN THE NEW CROWN

PRODUCT. THIS INCLUDES ANY DAMAGE TO ANOTHER PRODUCT OR PRODUCTS RESULTING FROM SUCH A DEFECT. SOME STATES DO NOT ALLOW THE EXCLUSION OR LIMITATIONS OF INCIDENTAL OR CONSEQUENTIAL DAMAGES, SO THE ABOVE LIMITATION OR EXCLUSION MAY NOT APPLY TO YOU.

#### WARRANTY ALTERATIONS

No person has the authority to enlarge, amend, or modify this Crown Warranty. This Crown Warranty is not extended by the length of time which you are deprived of the use of the new Crown product. Repairs and replacement parts provided under the terms of this Crown Warranty shall carry only the unexpired portion of this Crown Warranty.

#### DESIGN CHANGES

We reserve the right to change the design of any product from time to time without notice and with no obligation to make corresponding changes in products previously manufactured.

#### LEGAL REMEDIES OF PURCHASER

THIS CROWN WARRANTY GIVES YOU SPECIFIC LEGAL RIGHTS, YOU MAY ALSO HAVE OTHER RIGHTS WHICH VARY FROM STATE TO STATE. No action to enforce this Crown Warranty shall be commenced after expiration of the warranty period.

THIS STATEMENT OF WARRANTY SUPERSEDES ANY OTHERS CONTAINED IN THIS MANUAL FOR CROWN PRODUCTS. 9/07

## 8 Warranty



### WORLDWIDE EXCEPT USA & CANADA

#### SUMMARY OF WARRANTY

Crown International, 1718 West Mishawaka Road, Elkhart, Indiana 46517-4095 U.S.A. warrants to you, the ORIGINAL PURCHASER and ANY SUBSEQUENT OWNER of each NEW Crown1 product, for a period of three (3) years from the date of purchase by the original purchaser (the "warranty period") that the new Crown product is free of defects in materials and workmanship, and we further warrant the new Crown product regardless of the reason for failure, except as excluded in this Warranty.

*Warranty is only valid within the country in which the product is purchased.*

<sup>1</sup> Note: If your unit bears the name "Amcron," please substitute it for the name "Crown" in this warranty.

#### ITEMS EXCLUDED FROM THIS CROWN-WARRANTY

This Crown Warranty is in effect only for failure of a new Crown product which occurred within the Warranty Period. It does not cover any product which has been damaged because of any intentional misuse, accident, negligence, or loss which is covered under any of your insurance contracts. This Crown Warranty also does not extend to the new Crown product if the serial number has been defaced, altered, or removed.

#### WHAT THE WARRANTOR WILL DO

We will remedy any defect, regardless of the reason for failure (except as excluded), by repair, replacement, or refund. We may not elect refund unless you agree, or unless we are unable to provide replacement, and repair is not practical or cannot be timely made. If a refund is elected, then you must make the defective or malfunctioning product available to us free and clear of all liens or other encumbrances. The refund will be equal to the actual purchase price, not including interest, insurance, closing costs, and other finance charges less a reasonable depreciation on the product from the date of original purchase. Warranty work can only be performed at our authorized service centers. We will remedy the defect and ship the product from the service center within a reasonable time after receipt of the defective product at our authorized service center.

#### HOW TO OBTAIN WARRANTY SERVICE

You must notify your local Crown importer of your need for warranty service within the warranty period. All components must be shipped in the original box. Corrective action will be taken within a reasonable time of the date of receipt of the defective product by our authorized service center. If the repairs made by our authorized service center are not satisfactory, notify our authorized service center immediately.

#### DISCLAIMER OF CONSEQUENTIAL AND INCIDENTAL DAMAGES

YOU ARE NOT ENTITLED TO RECOVER FROM US ANY INCIDENTAL DAMAGES RESULTING FROM ANY DEFECT IN THE NEW CROWN PRODUCT. THIS INCLUDES ANY DAMAGE TO ANOTHER PRODUCT OR PRODUCTS RESULTING FROM SUCH A DEFECT.

#### WARRANTY ALTERATIONS

No person has the authority to enlarge, amend, or modify this Crown Warranty. This Crown Warranty is not extended by the length of time which you are deprived of the use of the new Crown product. Repairs and replacement parts provided under the terms of this Crown Warranty shall carry only the unexpired portion of this Crown Warranty.

#### DESIGN CHANGES

We reserve the right to change the design of any product from time to time without notice and with no obligation to make corresponding changes in products previously manufactured.

#### LEGAL REMEDIES OF PURCHASER

No action to enforce this Crown Warranty shall be commenced after expiration of the warranty period.

THIS STATEMENT OF WARRANTY SUPERSEDES ANY OTHERS CONTAINED IN THIS MANUAL FOR CROWN PRODUCTS. 9/07

## NOTES



**CROWN**

# PRODUCT REGISTRATION

Crown International  
 1718 W. Mishawaka Rd.  
 Elkhart, IN 46517-9439  
 Phone: 574-294-8000  
 Fax: 574-294-8329  
 www.crownaudio.com

Online registration is also available at <http://crownweb.crownintl.com/webregistration>.

*Warranty is only valid within the country in which the product is purchased.*

When this form is used to register your product, it may be mailed or faxed.

Crown International      Fax: 574-294-8329  
 1718 W Mishawaka Rd  
 Elkhart IN 46517

Please note that some information is required. Incomplete registrations will not be processed. \* Indicates required information.

## OWNER'S INFORMATION - PLEASE PRINT

\* First name: \_\_\_\_\_ Middle initial: \_\_\_\_\_ \* Last name: \_\_\_\_\_  
 Company: \_\_\_\_\_  
 \* Mailing address: \_\_\_\_\_  
 \* City: \_\_\_\_\_ \* State: \_\_\_\_\_ \* Zip Code: \_\_\_\_\_  
 \* Country: \_\_\_\_\_ E-mail address: \_\_\_\_\_  
 \* Phone # (include area code): \_\_\_\_\_ Fax #: \_\_\_\_\_

## PRODUCT INFORMATION

* MODEL	* SERIAL #	* PURCHASE DATE
e.g. IT8000, CDi1000, PCC160	e.g. 8000000000	mo/day/yr
_____	_____	____/____/____
_____	_____	____/____/____
_____	_____	____/____/____
_____	_____	____/____/____

Product purchased from: \*(Business/Individual) \_\_\_\_\_ Country: \_\_\_\_\_

Comments: \_\_\_\_\_  
 \_\_\_\_\_  
 \_\_\_\_\_

CUT ON THIS LINE

THIS PAGE INTENTIONALLY LEFT BLANK



# Crown Audio Factory Service Information

Shipping Address: Crown Audio Factory Service, 1718 W. Mishawaka Rd., Elkhart, IN 46517

**PLEASE PRINT CLEARLY**

SRA #: \_\_\_\_\_ (If sending product to Crown factory service.)      Model: \_\_\_\_\_      Serial Number: \_\_\_\_\_      Purchase Date: \_\_\_\_\_

## PRODUCT RETURN INFORMATION

Individual or Business Name: \_\_\_\_\_

Phone #: \_\_\_\_\_      Fax #: \_\_\_\_\_      E-Mail: \_\_\_\_\_

Street Address (please, no P.O. Boxes): \_\_\_\_\_

City: \_\_\_\_\_      State/Prov: \_\_\_\_\_      Postal Code: \_\_\_\_\_      Country: \_\_\_\_\_

Nature of problem: \_\_\_\_\_

\_\_\_\_\_

\_\_\_\_\_

Other equipment in your system: \_\_\_\_\_

If warranty is expired, please provide method of payment. Proof of purchase may be required to validate warranty.

## PAYMENT OPTIONS

I have open account payment terms. Purchase order required. PO# \_\_\_\_\_       COD

Credit Card (Information below is required; however if you do not want to provide this information at this time, we will contact you for the information when your unit is repaired).

Credit card information:

Type of credit card:     Master Card       Visa       American Express       Discover

Type of credit card account:     Personal/Consumer       Business/Corporate

Card # \_\_\_\_\_      Exp. date: \_\_\_\_\_      \* Card ID #: \_\_\_\_\_

\* Card ID # is located on the back of the card following the credit card #, in the signature area. On American Express, it may be located on the front of the card. This number is required to process the charge to your account. If you do not want to provide it at this time, we will call you to obtain this number when the repair of your unit is complete.

Name on credit card: \_\_\_\_\_

Billing address of credit card: \_\_\_\_\_

\_\_\_\_\_

\_\_\_\_\_



**H** A Harman International Company