

# TASCAM

# GB-10

## Guitar & Bass Trainer/Recorder

This device has a serial number located on the bottom panel. Please record it and retain it for your records.

Serial number:

\_\_\_\_\_

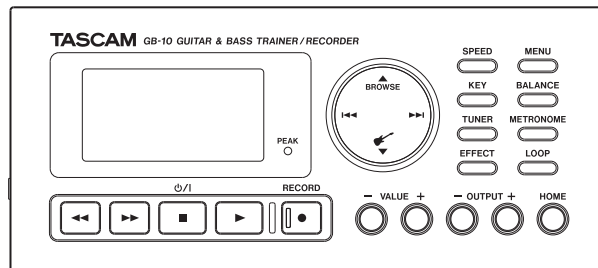

## OWNER'S MANUAL

# IMPORTANT SAFETY INSTRUCTIONS



CAUTION: TO REDUCE THE RISK OF ELECTRIC SHOCK, DO NOT REMOVE COVER (OR BACK). NO USER-SERVICEABLE PARTS INSIDE. REFER SERVICING TO QUALIFIED SERVICE PERSONNEL.



The lightning flash with arrowhead symbol, within equilateral triangle, is intended to alert the user to the presence of uninsulated "dangerous voltage" within the product's enclosure that may be of sufficient magnitude to constitute a risk of electric shock to persons.



The exclamation point within an equilateral triangle is intended to alert the user to the presence of important operating and maintenance (servicing) instructions in the literature accompanying the appliance.

## Declaration of Conformity

Model Number: GB-10  
Trade Name: TASCAM  
Responsible party: TEAC AMERICA, INC.  
Address: 7733 Telegraph Road, Montebello,  
California, U.S. A.  
Telephone number: 1-323-726-0303

This device complies with Part 15 of the FCC Rules. Operation is subject to the following two conditions: (1) this device may not cause harmful interference, and (2) this device must accept any interference received, including interference that may cause undesired operation.

**WARNING: TO PREVENT FIRE OR SHOCK HAZARD, DO NOT EXPOSE THIS APPLIANCE TO RAIN OR MOISTURE.**

FOR U.S.A.

TO THE USER

This equipment has been tested and found to comply with the limits for a Class B digital device, pursuant to Part 15 of the FCC Rules. These limits are designed to provide reasonable protection against harmful interference in a residential installation. This equipment generates, uses, and can radiate radio frequency energy and, if not installed and used in accordance with the instruction manual, may cause harmful interference to radio communications. However, there is no guarantee that interference will not occur in a particular installation. If this equipment does cause harmful interference to radio or television reception, which can be determined by turning the equipment off and on, the user is encouraged to try to correct the interference by one or more of the following measures.

- Reorient or relocate the receiving antenna.
- Increase the separation between the equipment and receiver.
- Connect the equipment into an outlet on a circuit different from that to which the receiver is connected.
- Consult the dealer or an experienced radio/TV technician for help.

### CAUTION

Changes or modifications to this equipment not expressly approved by TEAC CORPORATION for compliance could void the user's authority to operate this equipment.

# IMPORTANT SAFETY INSTRUCTIONS

- 1 Read these instructions.
- 2 Keep these instructions.
- 3 Heed all warnings.
- 4 Follow all instructions.
- 5 Do not use this apparatus near water.
- 6 Clean only with dry cloth.
- 7 Do not block any ventilation openings. Install in accordance with the manufacturer's instructions.
- 8 Do not install near any heat sources such as radiators, heat registers, stoves, or other apparatus (including amplifiers) that produce heat.
- 9 Do not defeat the safety purpose of the polarized or grounding-type plug. A polarized plug has two blades with one wider than the other. A grounding type plug has two blades and a third grounding prong. The wide blade or the third prong are provided for your safety. If the provided plug does not fit into your outlet, consult an electrician for replacement of the obsolete outlet.
- 10 Protect the power cord from being walked on or pinched particularly at plugs, convenience receptacles, and the point where they exit from the apparatus.
- 11 Only use attachments/accessories specified by the manufacturer.
- 12 Use only with the cart, stand, tripod, bracket, or table specified by the manufacturer, or sold with the apparatus. When a cart is used, use caution when moving the cart/apparatus combination to avoid injury from tip-over.



- 13 Unplug this apparatus during lightning storms or when unused for long periods of time.
- 14 Refer all servicing to qualified service personnel. Servicing is required when the apparatus has been damaged in any way, such as power-supply cord

or plug is damaged, liquid has been spilled or objects have fallen into the apparatus, the apparatus has been exposed to rain or moisture, does not operate normally, or has been dropped.

- Do not expose this apparatus to drips or splashes.
- Do not place any objects filled with liquids, such as vases, on the apparatus.
- Do not install this apparatus in a confined space such as a book case or similar unit.
- The apparatus draws nominal non-operating power from the AC outlet with its POWER or STANDBY/ON switch not in the ON position.
- The apparatus should be located close enough to the AC outlet so that you can easily grasp the power cord plug at any time.
- The mains plug is used as the disconnect device, the disconnect device shall remain readily operable.
- If the product uses batteries (including a battery pack or installed batteries), they should not be exposed to sunshine, fire or excessive heat.
- CAUTION for products that use replaceable lithium batteries: there is danger of explosion if a battery is replaced with an incorrect type of battery. Replace only with the same or equivalent type.
- Caution should be taken when using earphones or headphones with the product because excessive sound pressure (volume) from earphones or headphones can cause hearing loss.
- If you are experiencing problems with this product, contact TEAC for a service referral. Do not use the product until it has been repaired.

# IMPORTANT SAFETY INSTRUCTIONS

## ■ Cautions about Batteries

This product uses batteries. Misuse of batteries could cause a leak, rupture or other trouble. Always abide by the following precautions when using batteries.

- Never recharge non-rechargeable batteries. The batteries could rupture or leak, causing fire or injury.
  - When installing batteries, pay attention to the polarity indications (plus/minus (+/-) orientation), and install them correctly in the battery compartment as indicated. Putting them in backward could make the batteries rupture or leak, causing fire, injury or stains around them.
  - When throwing used batteries away, follow the disposal instructions indicated on the batteries and the local disposal laws. When you store or dispose of batteries, isolate their terminals with insulation tape or something like that to prevent them from contacting other batteries or metallic objects.
  - Do not use batteries other than those specified. Do not mix and use new and old batteries or different types of batteries together. The batteries could rupture or leak, causing fire, injury or stains around them.
  - Do not carry or store batteries together with small metal objects. The batteries could short, causing leak, rupture or other trouble.
  - Do not heat or disassemble batteries. Do not put them in fire or water. Batteries could rupture or leak, causing fire, injury or stains around them.
  - If the battery fluid leaks, wipe away any fluid on the battery case before inserting new batteries. If the battery fluid gets in an eye, it could cause loss of eyesight. If fluid does enter an eye, wash it out thoroughly with clean water without rubbing the eye and then consult a doctor immediately. If the fluid gets on a person's body or clothing, it could cause skin injuries or burns. If this should happen, wash it off with clean water and then consult a doctor immediately.
  - The unit power should be off when you install and replace batteries.
- Remove the batteries if you do not plan to use the unit for a long time. Batteries could rupture or leak, causing fire, injury or stains around them. If the battery fluid leaks, wipe away any fluid on the battery compartment before inserting new batteries.

# IMPORTANT SAFETY INSTRUCTIONS

## 产品有毒有害物质或元素的名称及含量

机种：GB-10		有毒有害物质或元素					
	品名	铅 (Pb)	汞 (Hg)	镉 (Cd)	六价铬 (Cr (VI))	多溴联苯 (PBB)	多溴二苯醚 (PBDE)
1	CHASSIS部份	○	○	○	○	○	○
2	PCB Assy部份	×	○	○	○	○	○
3	线材部份	○	○	○	○	○	○
4	附属品部份	×	○	○	○	○	○
5	SEAL部份	○	○	○	○	○	○
6	包装部份	○	○	○	○	○	○

○：表示该有毒有害物质在该部件所有均质材料中的含有量均在 SJ/T11363-2006 标准规定的限量要求以下。

×：表示该有毒有害物质至少在该部件的某一均质材料中的含量超出 SJ/T11363-2006 标准规定的限量要求。

(针对现在代替技术困难的电子部品及合金中的铅)

# Table of Contents

<b>IMPORTANT SAFETY INSTRUCTIONS .....</b>	<b>2</b>	Top panel .....	23
<b>Quick Start Guide .....</b>	<b>10</b>	Left side panel.....	29
Step 1: Prepare the SD card and power .....	10	Right side panel.....	29
Step 2: Copy audio files from a computer.....	12	Rear panel.....	30
Step 3: Connect an instrument and headphones .....	12	Bottom panel .....	30
Step 4: Tune the instrument.....	13	Home Screen .....	31
Step 5: Use the effects.....	13	Recording screen .....	33
Step 6: Adjust the input and output levels .....	14	Menu structure .....	34
Step 7: Play along with the music.....	15	Using the menu.....	35
Step 8: Record your performance .....	16	Basic operations .....	36
Step 9: Record over a song (overdub) .....	17	<b>3-Preparation .....</b>	<b>37</b>
Step 10: Use other functions .....	17	Inserting and removing SD cards .....	37
Step 11: Turn off the power.....	17	Inserting an SD card.....	37
<b>1-Introduction.....</b>	<b>18</b>	Removing an SD card .....	38
Main functions and features.....	18	Preparing an SD card for use .....	38
Included items .....	19	Special cases .....	39
About this manual.....	19	Card write protection .....	39
Intellectual property rights .....	20	Powering the unit.....	40
About SD cards.....	21	Using AA batteries .....	40
Precautions for use .....	21	Using USB bus power .....	40
Precautions for placement and use .....	22	Using an AC adaptor (sold separately) .....	41
Beware of condensation .....	22	Startup and shutdown.....	42
Cleaning the unit .....	22	Turning the power on.....	42
<b>2 – Names and Functions of Parts .....</b>	<b>23</b>	Setting the power to standby.....	42

<b>4-Connecting .....</b>	<b>43</b>	Icons on the BROWSE screen.....	53
Connecting monitoring equipment .....	43	File operations .....	54
Connecting with a computer .....	43	Folder operations.....	55
Disconnecting from a computer .....	44	Delete the selected playback file (QUICK DELETE) .....	56
Connecting a guitar or a bass.....	44	<b>7-Playback .....</b>	<b>57</b>
<b>5-Recording.....</b>	<b>45</b>	Playback .....	57
Setting the location where recorded files are saved.....	45	Stopping playback .....	57
Adjusting the input level .....	45	Selecting a file.....	57
Recording .....	46	Searching forward and backward.....	58
Recording a few seconds before pushing the record		Adjusting the playback volume.....	58
button (pre-recording) .....	46	Adjusting the balance between playback and input	
Recording the input sound with the playback sound		signals .....	59
(overdubbing).....	47	Disabling the guitar input .....	59
Overdubbing .....	47	<b>8-Playback Area and Playlist .....</b>	<b>60</b>
Starting and pausing recording automatically		Using the PLAY MODE screen to set the playback area ....	60
(AUTO REC).....	48	Selecting a folder for the playback area (1).....	61
Track incrementation .....	50	Selecting a folder for the playback area (2).....	62
Manual track incrementation during recording .....	50	Playlist.....	63
Automatic track incrementation by file size.....	50	Adding files to the playlist .....	63
Dividing files (DIVIDE) .....	50	Editing the playlist .....	63
Recording duration.....	52	<b>9-Special Playback (playback control function).....</b>	<b>66</b>
<b>6-Working with Files and Folders (BROWSE screen)</b>		Changing the speed .....	66
<b>.....</b>	<b>53</b>	Changing the key.....	66
BROWSE screen navigation.....	53		

# Table of Contents

Jump back a set amount and continue playback (flashback) .....	67	Setting the forward/backward search speed.....	80
<b>10-Loop Playback/Repeat Playback/Single Track Playback .....</b>	<b>68</b>	Setting the automatic power off time .....	80
Using loop playback (standard mode).....	68	Adjusting the display contrast .....	80
Using loop playback with the playlist .....	69	Setting the battery type .....	80
Turning loop playback on and off.....	70	Restoring the default values (factory settings) .....	81
Repeat and single track playback .....	71	Using QUICK FORMAT .....	81
<b>11-Transferring songs to and from a computer .....</b>	<b>72</b>	Using FULL FORMAT .....	81
Preparing audio files on a computer .....	72	Changing the file name prefix .....	82
Copying audio files from a computer.....	72	<b>16-Using the footswitch .....</b>	<b>83</b>
Transferring audio files to a computer .....	73	Setting footswitch operation .....	83
<b>12-Using the built-in effects .....</b>	<b>74</b>	Using the footswitch .....	83
Turning the effects ON and OFF .....	74	<b>17-Viewing File Information .....</b>	<b>84</b>
Setting the effect .....	74	File information page .....	84
<b>13-Using the tuner.....</b>	<b>77</b>	Card information page.....	85
Preparation .....	77	System information page .....	86
Chromatic tuner mode (AUTO) .....	78	<b>18-Effect Module Parameters List .....</b>	<b>87</b>
Oscillator mode .....	78	<b>19-Messages.....</b>	<b>89</b>
<b>14-Using the Metronome.....</b>	<b>79</b>	<b>20-Troubleshooting .....</b>	<b>93</b>
Setting the metronome.....	79	<b>21-Specifications .....</b>	<b>95</b>
Starting and stopping the metronome .....	79	Ratings.....	95
<b>15-System settings .....</b>	<b>80</b>	Input ratings .....	95
System settings (SETUP).....	80	Analog audio input.....	95
		output ratings .....	95
		Analog output ratings .....	95



Control input/output ratings .....	95
Audio performance .....	96
Computer compatibility .....	96
Other specifications .....	97
Dimensional drawings .....	97

# Quick Start Guide

## Step 1: Prepare the SD card and power

### ■ Install the SD card

Insert the SD card into the SD card slot, which is inside the battery compartment on the bottom of the unit.

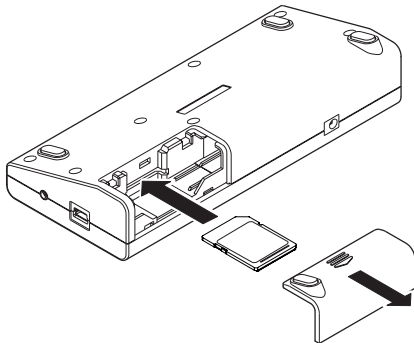

Formatting is necessary if you insert a new SD card.  
(Formatting will erase all the data on the card.)

For details, see “Inserting and removing SD cards” on page 37.

### ■ Preparing the power

#### Using AA batteries

Insert AA batteries into the battery compartment, which you opened when installing the SD card. This unit can use either alkaline or nickel-metal hydride (NiMH) batteries. It cannot recharge batteries.

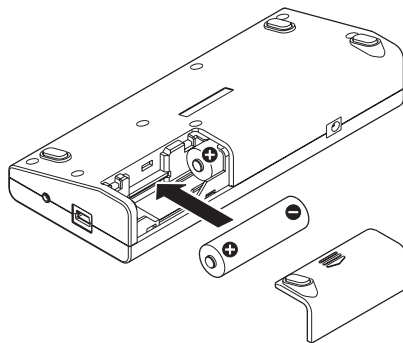

## Using USB bus power

Connect the unit with a computer using the included USB cable.

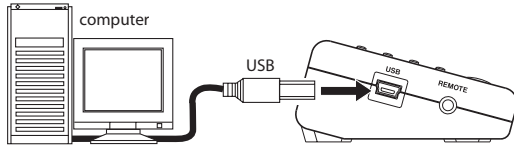

The USB SELECT screen appears, allowing you to set whether to use USB bus power or to connect the unit's storage to the computer. Select "BUS POWER".



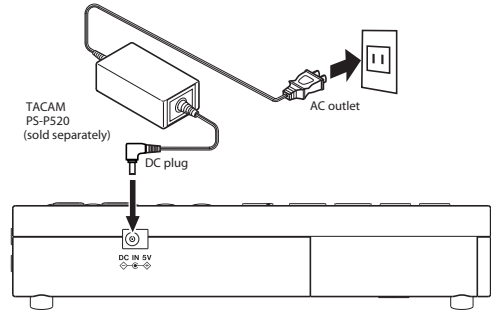

## Using an AC adaptor (sold separately)

Connect a TASCAM PS-P520 AC adaptor (sold separately), which is designed for the specifications of this unit, to the DC IN 5V jack.



## ■ Turn the power on

Press and hold the  /  button until the startup screen opens.



For details about power preparations, see "Powering the unit" on page 40.

### Step 2: Copy audio files from a computer

#### ■ Prepare the audio files

Create audio files using the functions of the computer operating system or other computer software applications.

Be sure to use file formats that this unit can play back. These formats include MP3 (32–320 kbps, 44.1 kHz) and WAV (44.1 kHz, 16/24-bit).

#### ■ Connect the computer

Use the included USB cable to connect the unit to the computer.

#### ■ Transfer files from the computer

Copy audio files to the *MUSIC* folder on the GB-10 drive that appears on the computer.

#### ■ Disconnect from the computer

After using the correct procedures to dismount the GB-10 drive from your computer, disconnect the USB cable. The unit should automatically turn off.

For details, see Chapter 11 “Transferring songs to and from a computer” on page 72.

### Step 3: Connect an instrument and headphones

#### ■ Connect a guitar or bass

Connect a guitar or bass to the unit’s **GUITAR IN** jack using a shielded cable.

For details, see “Connecting a guitar or a bass” on page 44.

#### CAUTION

In order to record sound input through the **GUITAR IN** jack and hear the signal through headphones, the **G.IN** icon must appear highlighted (light letters on a dark background). If it does not appear, press the  to make it appear.

#### ■ Connect headphones or speakers

Connect headphones or a monitoring system (such as powered speakers or an amplifier and speakers) to this unit’s /LINE OUT jack.

For details, see “Connecting monitoring equipment” on page 43.

## CAUTION

Before connecting headphones, use the **OUTPUT** (–) button to minimize the volume. Failure to do so could cause the sudden output of loud sounds, which might lead to hearing damage or other harm.

## Step 4: Tune the instrument

Use the unit's tuning function to tune a connected guitar or bass.

Press the **TUNER** button to open the TUNER screen.

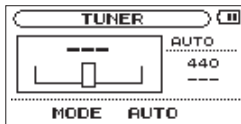

For details, see Chapter 13 "Using the tuner" on page 77.

## Step 5: Use the effects

This unit has built-in effects that you can use to add overdrive and reverb, for example, to the sound of your guitar or bass.

Press the **EFFECT** button briefly to enable the effects. The last effect setting used is activated and the FX icon appears highlighted (light letters on a dark background).

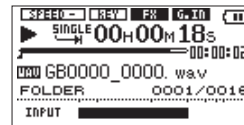

Press this button again to disable the effects. The FX icon appears as dark letters on a light background.

Press and hold the **EFFECT** button to open the EFFECT screen where you can make detailed settings.

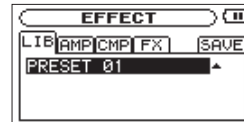

For details, see Chapter 12 "Using the built in effects" on page 74.

## Quick Start Guide

### Step 6: Adjust the input and output levels

#### ■ Adjust the headphones volume

Use the **OUTPUT** (+/-) buttons to adjust the headphones volume.

When adjusting the volume, the current level appears in a pop-up at the bottom of the display.

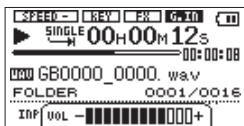

For details, see “Adjusting the playback volume” on page 58.

#### ■ Adjusting the guitar input level

Use the **INPUT** level dial on the right side panel to adjust the **GUITAR IN** input level.

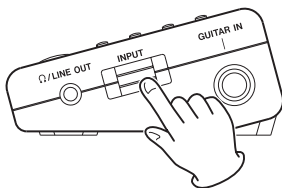

For details, see “Adjusting the input level” on page 45.

#### ■ Adjusting the mix

Press the **BALANCE** button to adjust the volume of the file that is playing. Use this function to adjust the balance between the playback sound and the sound of the input guitar. Press the ► button to start playback of the song. Adjust the volume of the playback sound using the **VALUE** (+/-) buttons. While playing the guitar, adjust the balance between the playing song and the guitar.

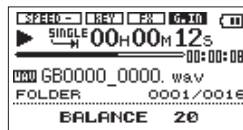

#### NOTE

The **BALANCE** setting only affects the volume when **G.IN** is ON ( **G.IN** ). When **G.IN** is OFF ( **G.IN** ), changing the **BALANCE** value has no effect on the volume.

## Step 7: Play along with the music

This unit will output the sound of a connected guitar even when recording is not enabled. This allows you to play along on your guitar or bass just by selecting a song and pressing the ► button.

This unit also has the following functions, which you can use as you like to make practicing your instrument even easier.

### ■ Use repeat playback

You can use two types of repeat playback. You can either play a loop between two set points or play an entire song and the entire playback area repeatedly.

Use the **LOOP** button for loop playback, which is useful for practicing a phrase repeatedly.

During playback (or when paused), press the **LOOP** button briefly at the point where you want to start loop playback to set the IN point. Then, press the **LOOP** button briefly again at the point where you want to stop loop playback to set the OUT point and start loop playback of the interval between the points.

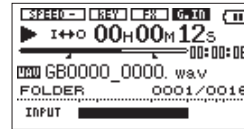

Press and hold the **LOOP** button to open the LOOP SET pop-up screen where you can make fine adjustments to the IN and OUT points. Other loop playback functions include, for example, the possibility of setting up to five loops for each file when the playback area is the playlist.

For details about loop playback see “Using loop playback (standard mode)” on page 68 and “Using loop playback with the playlist” on page 69.

For repeat playback of a single file or the entire playback area, press the **MENU** button to open the MENU screen, select **PLAY MODE** and press the ► or ►► button. Use the **VALUE** (+/-) buttons to select 1 REPEAT or ALL REPEAT.

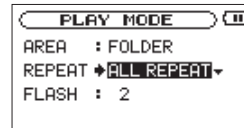

After making the setting, press the **HOME** button to return to the Home Screen.

## Quick Start Guide

For details about repeat playback, see “Repeat and single track playback” on page 71.

### ■ Change the key

You can change the playback pitch (key) in semitones. Press the **KEY** button to show the key setting at the bottom of the display.

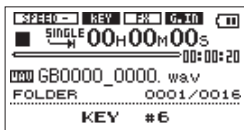

Use the **VALUE** (+/-) buttons to change the setting value.

For details, see “Changing the key” on page 66.

### ■ Changing the speed

You can also change the playback speed without changing the pitch.

You can, for example, reduce the speed to practice a song and gradually increase it as you become more proficient.

Press the **SPEED** button to show the speed setting at the bottom of the display.

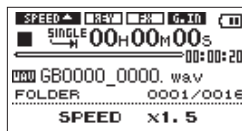

Use the **VALUE** (+/-) buttons to change the setting value.

For details, see “Changing the speed” on page 66.

---

## Step 8: Record your performance

---

You can record the sound input through the **GUITAR IN** jack. Press the **RECORD** [●] button to start recording. (except when the auto-record function is on and the input level is below the set value). Press and hold the **RECORD** [●] button to enable the pre-record function and put the unit into recording standby. Press the **RECORD** [●] button to start recording, capturing sound up to 2 seconds before pressing the button. Press the **⏏** / **I** [■] button to stop recording.

For details, see “Recording” on page 46.



## Step 9: Record over a song (overdub)

You can also record your performance together with the music that is playing back.

Use the ◀◀ and ▶▶ buttons to select the song. Press the ▶ button while pressing and holding the **RECORD** [●] button to begin overdubbing.

Press the ⏻ / [■] button to stop recording.

For details, see “Recording the input sound with the playback sound (overdubbing)” on page 47.

### CAUTION

If you press and hold the record button, the unit will be put in recording standby with the pre-record function enabled, and overdubbing will not be possible.

## Step 10: Use other functions

This unit has other functions, including a convenient playlist and the ability to divide files, which you can use as you like.

One such function is the metronome, which can be accessed easily by pressing the **METRONOME** button.

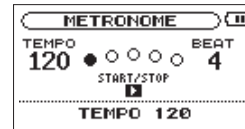

For details, see chapter 14 “Using the Metronome” on page 79.

## Step 11: Turn off the power

To turn the power off (put the unit in standby), press the ⏻ / [■] button and hold it until the shutdown screen appears.



# 1-Introduction

Thank you very much for purchasing the TASCAM GB-10 Guitar & Bass Trainer/Recorder. Please read this Owner's Manual carefully in order to maximize your use of all the unit's features. We hope that you will enjoy using this trainer/recorder for many years to come. Please keep a copy of this manual in a safe place for future reference.

You can also download a digital version of this manual from the TASCAM website (<http://www.tascam.com/>).

---

## Main functions and features

---

- Portable trainer/recorder for guitar and bass players
- Uses SD cards as recording media
- Recording the connected guitar or bass possible
- Recording 44.1 kHz, 16-bit linear PCM (WAV format) possible
- Overdubbing the input signal with the audio playing back possible
- Playback of 44.1 kHz, 16/24-bit linear WAV files and 44.1 kHz, 32–320 kbps MP3 files possible
- Metronome functions
- Built-in effects can be applied to the input signal
- Tuner functions
- Auto recording function can detect the sound input level to start recording automatically
- Recording continues automatically in a new file without pause when the maximum file size is reached during recording
- Track incrementation function allows the creation of a new file when desired during recording without pause
- VSA function allows adjustment of the playback speed in a range from 50% to 150% (in 10% increments) without changing the playback pitch
- Key adjustment function allows the pitch to be adjusted by  $\pm 6$  semitones (in semitone increments)
- Repeat playback and IN-OUT loop playback functions
- Playlist function
- In playlist mode, up to five IN-OUT loop playback settings can be made for each file
- Divide function allows files to be split where desired
- A user word can be set for automatic file naming
- 1/4" mono guitar/bass input jack
- 1/8" line output/headphones output jack
- 128 × 64 pixel dot matrix LCD
- Mini-B type USB 2.0 port

- Can be powered by two AA batteries, USB bus power or a TASCAM PS-P520 AC adaptor (sold separately)
- Files saved on a computer can be transferred (copied) to the SD card in this unit via USB

## Included items

The included items are listed below.

Take care when opening the package not to damage the items. Keep the package materials for transportation in the future.

Please contact the store where you purchased this unit if any of these items are missing or have been damaged during transportation.

- Main unit ..... 1
- SD memory card (in the unit) ..... 1
- AA alkaline battery ..... 2
- USB cable (0.8 m) ..... 1
- A warranty card..... 1
- Owner's manual (this manual)..... 1

## About this manual

In this manual, we use the following conventions:

- “SD memory card” is sometimes abbreviated as “SD card.”
- The names of keys and controls are given in the following bold typeface: **MENU**
- Messages shown on the unit's display are written like this:  
ON
- Characters that appear on a computer display are given in the following light typeface: OK
- Additional information is introduced in the styles below when needed:

### TIP

Useful hints when using the unit.

### NOTE

Explanation of actions in special situation and supplement.

### CAUTION

Instructions that should be followed to avoid injury, damage to the unit or other equipment, and loss of data.

# 1-Introduction

## Intellectual property rights

- TASCAM is a trademark of TEAC Corporation, registered in the U.S. and other countries.
- SDHC Logo is a trademark of SD-3C, LLC.



- Supply of this product does not convey a license nor imply any right to distribute MPEG Layer-3 compliant content created with this product in revenue-generating broadcast systems (terrestrial, satellite, cable and/or other distribution channels), streaming applications (via Internet, intranets and/or other networks), other content distribution systems (pay-audio or audio-on-demand applications and the like) or on physical media (compact discs, digital versatile discs, semiconductor chips, hard drives, memory cards and the like). An independent license for such use is required. For details, please visit <http://mp3licensing.com>.
- MPEG Layer-3 audio coding technology licensed from Fraunhofer IIS and Thomson.
- Microsoft, Windows, Windows XP, Windows Vista, and Windows 7 are either registered trademarks or trademarks

of Microsoft Corporation in the United States and/or other countries.

- Apple, Macintosh, iMac, Mac OS and Mac OS X are trademarks of Apple Inc.
- Other company names, product names and logos in this document are the trademarks or registered trademarks of their respective owners.

Any data, including, but not limited to information, described herein are intended only as illustrations of such data and/or information and not as the specifications for such data and/or information. TEAC Corporation disclaims any warranty that any use of such data and/or information shall be free from infringement of any third party's intellectual property rights or other proprietary rights, and further, assumes no liability of whatsoever nature in the event of any such infringement, or arising from or connected with or related to the use of such data and/or information.

This product is designed to help you record and reproduce sound works to which you own the copyright, or where you have obtained permission from the copyright holder or the rightful licensor. Unless you own the copyright, or have obtained the appropriate permission from the copyright holder or the rightful licensor, your unauthorized recording, reproduction or distribution thereof may result in severe criminal penalties under copyright laws and international copyright treaties. If you are uncertain about your rights, contact your legal advisor. Under no circumstances will TEAC Corporation be responsible for the consequences of any illegal copying performed using the recorder.

## About SD cards

This unit uses SD cards for recording and playback.

You can use 64 MB–2 GB SD cards and 4 GB–32 GB SDHC cards with this unit.

A list of SD cards that have been tested with this unit can be found on the TASCAM web site ([www.tascam.com/](http://www.tascam.com/)).

Use of cards that have not been verified for use with this unit could result in the unit not functioning properly.

## Precautions for use

SD cards are delicate media. In order to avoid damaging a card or the card slot, please take the following precautions when handling them.

- Do not leave in extremely hot or cold places.
- Do not leave them in extremely humid places.
- Do not let them get wet.
- Do not put things on top of them or twist them.
- Do not hit them.

# 1-Introduction

---

## Precautions for placement and use

---

- The operating temperature should be between 0°C and 40°C (32°F and 104°F).
- Do not install in the following types of places. Doing so could degrade the sound quality and/or cause malfunctions.
  - Places with significant vibrations or that are otherwise unstable
  - Near windows or other places exposed to direct sunlight
  - Near heaters or other extremely hot places
  - Extremely cold places
  - Places with bad ventilation or high humidity
  - Very dusty locations
- Avoid installing this unit on top of any heat-generating electrical device such as a power amplifier.

---

## Beware of condensation

---

If the unit is moved from a cold to a warm place, or used after a sudden temperature change, there is a danger of condensation; vapor in the air could condense on the internal mechanism, making correct operation impossible. To prevent this, or if this occurs, let the unit sit for one or two hours at the new room temperature before using.

---

## Cleaning the unit

---

Use a dry soft cloth to wipe the unit clean. Do not clean the unit with a chemically treated cloth or substances such as benzene, thinner and alcohol because they might cause damage to the surface of the unit.

# 2 – Names and Functions of Parts

## Top panel

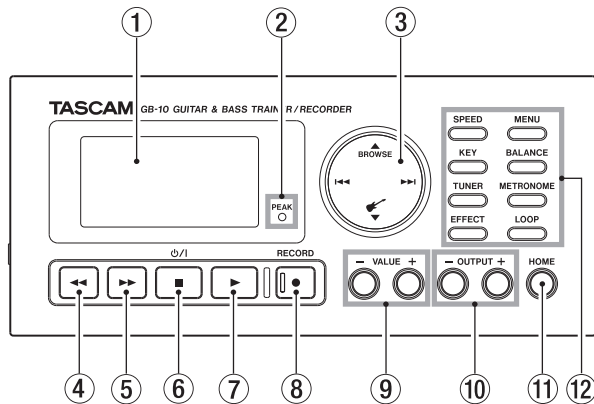

① **Display**

This shows a variety of information.

② **PEAK indicator**

This lights if the input signal level is too high.

③ **Cursor control**

Press up to use the ▲/**BROWSE** button, down to use the ▼/**GUITAR INPUT** button, left to use the ◀◀ button and right to use the ▶▶ button.

▲/**BROWSE** button (UP/**BROWSE**)

When the Home Screen is open, press this button to open the **BROWSE** screen.

When one of the setting screens is open, this moves the cursor up on the screen.

When the Home Screen is open, press and hold this button to open the **QUICK DELETE** pop-up menu.

▼/**GUITAR INPUT** button (DOWN/**GUITAR INPUT**)

When the Home Screen is open, press this button to turn the input from the **GUITAR IN** jack ON/OFF.

When one of the setting screens is open, this moves the cursor down on the screen.

◀◀ button (**PREVIOUS**)

During playback or when stopped in the middle of file playback, press this button to return to skip to the beginning of the previous file.

When stopped at the beginning of a file, press this button to skip to the beginning of the previous file.

## 2–Names and Functions of Parts

When one of the setting screens is open, this moves the cursor to the left on the screen.

On the **BROWSE** screen, press this button to return to the higher folder level.

### ▶▶ **button (NEXT)**

During playback or when stopped, press this button to skip to the beginning of the next file.

When one of the setting screens is open, this moves the cursor to the right on the screen.

On the **BROWSE** screen, press this to enter the lower folder level.

Press during recording to start recording to a new file without interruption (track incrementation).

### ④ ◀◀ **button (REW)**

Press this button to search backward.

Press briefly to search backward to the beginning of the current file. Each time you press this button, the search speed increases.

Press and hold to search backward continuously for as long as the button is pressed. When the beginning of the current file is reached, searching stops there.

### ⑤ ▶▶ **button (F FWD)**

Press this button to search forward.

Press briefly to search forward to the end of the current file. Each time you press this button, the search speed increases.

Press and hold to search forward continuously for as long as the button is pressed. When the end of the current file is reached, searching stops there.

### ⑥ ⏻ / [■] **button (POWER, STOP)**

Use to stop recording and playback, as well as to end recording standby.

Press during playback to pause playback. Press again when paused to stop playback.

Use also to respond “NO” to a confirmation pop-up message that appears during the operation of a setting screen.

Use to return from the **FILE INFORMATION** pop-up message when using the browse function.

Press and hold to turn the power ON or put the unit into standby.



## 2–Names and Functions of Parts

### ⑦ ► **button (PLAY)**

When the Home Screen is open, press when stopped to start playback.

Press during playback to return to a specific time and restart playback (flashback function). (See “Jump back a set amount and continue playback (flashback)” on page 67)

When the METRONOME screen is open, press to start and stop the metronome.

Use during operation of a setting screen to confirm the selection of an item and to respond “YES” to confirmation pop-up messages.

Press this button while pressing and holding the **RECORD** [●] button to start overdubbing. (See “Recording the input sound with the playback sound (overdubbing)” on page 47.)

### ⑧ **RECORD** [●] **button/indicator**

Press briefly when stopped to start recording. When recording, the indicator lights. When the auto record function is ON, press briefly to start recording standby. When in recording standby, the indicator blinks.

Press and hold when stopped to enable prerecording (2 seconds maximum) and start recording standby. When in recording standby, the indicator blinks. Press during

recording standby to start recording. When recording, the indicator lights.

Press the ► button while pressing and holding this button to start overdubbing. (See “Recording the input sound with the playback sound (overdubbing)” on page 47.)

On the DIVIDE screen, use to execute the division of a file.

### ⑨ **VALUE (+/-) buttons**

Use these to change setting values. Press + to increase the value or – to decrease the value.

Press + and - buttons at the same time to set it to the default value.

### ⑩ **OUTPUT (+/-) buttons**

Use these to adjust the volume level of the output from the Ω/LINE OUT jack. When using these buttons, the volume level is shown in a pop-up at the bottom of the display.

Press + to increase the volume or – to decrease the volume.

### ⑪ **HOME button**

Press to return to the Home Screen from one of the setting screens.

## 2–Names and Functions of Parts

### 12 Trainer buttons

In addition to the **MENU** button, which opens the MENU screen, this section has seven buttons that allow direct access to various training functions. By using them, you can change their settings without having to return to the Home Screen each time.

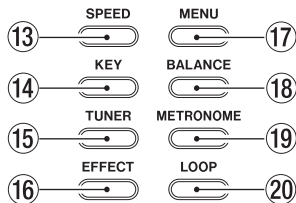

### 13 SPEED button

Press to change the playback speed.

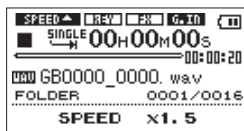

Use the **VALUE** (+/–) buttons to increase/decrease the playback speed. For details, see “Changing the speed” on page 66.

### 14 KEY button

Press to change the pitch of the playback. Press to cycle between the two modes. Use the **VALUE** (+/–) buttons to increase/decrease the pitch.

Adjust the pitch in semitones using the **KEY** mode.

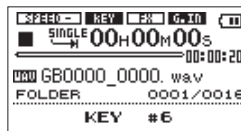

Adjust the pitch in cents using the **FINE TUNE** mode.

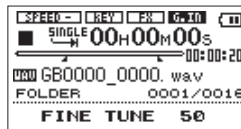

For details, see “Changing the key” on page 66.

### 15 TUNER button

Press to tune the connected guitar/bass.

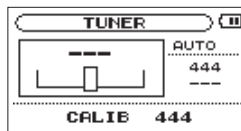

## 2–Names and Functions of Parts

First, set the tuner mode to **AUTO** or **OSC** using the **ϕ / I** [**■**] button (**AUTO**) and **▶** button (**OSC**). Then, press the **TUNER** button again and change the setting for the mode using the **VALUE (+/-)** button or **▶** button.

For details, see Chapter 13 “Using the tuner” on page 77.

### 16 **EFFECT** button

Press briefly to turn the effects ON/OFF. When ON, the FX icon appears with light letters on a dark background.



Press and hold to open the **EFFECT** screen where you can make detailed settings.

For details, see Chapter 12 “Using the built in effects” on page 74.

### 17 **MENU** button

When the Home Screen is open, press this button to open the **MENU** screen.



The cursor starts on the last used item.

Press this button when one of the setting screens is open to return to the **MENU** screen.

Press this button when the **MENU** screen is open to return to the Home Screen.

For details, see “Using the menu” on page 35.

### 18 **BALANCE** button

Press to change the volume level of the playback sound and balance playback and input signals.

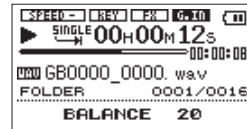

Use the **VALUE (+/-)** buttons to increase/decrease the playback volume.

For details, see “Adjusting the balance between playback and input signals” on page 59.

### **NOTE**

The **BALANCE** setting only affects the volume when **G.IN** is ON ( **G.IN** ). When **G.IN** is OFF ( **OFF** ), changing the **BALANCE** value has no effect on the volume.

## 2–Names and Functions of Parts

### 19 METRONOME button

Press to use the metronome.

Press this button to cycle through the TEMPO, BEAT and LEVEL settings in order.

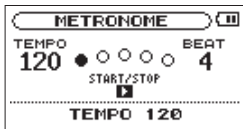

Use the **VALUE** (+/-) buttons to change the value of each setting.

For details, see Chapter 14 “Using the Metronome” on page 79.

### 20 LOOP button

When the playback area is not set to playlist, press this button briefly to set the IN point (loop playback starting point) at the current location. Press briefly again to set the OUT point (loop playback ending point) and start loop playback.

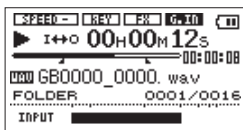

Press briefly again to turn the loop playback function OFF.

When the playback area is set to playlist, press this button briefly to show the currently selected loop number.

If the loop range has been set, the “**I**” and “**O**” icons will appear under the playback position bar.

Use the **VALUE** (+/-) buttons to change the selected loop number (LOOP 1 – LOOP 5).

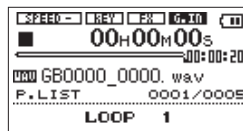

When the playback area is set to playlist, press and hold this button to show the loop screen.

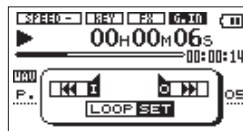

Press the **I** button designate the IN point, and press the **O** button to designate the OUT point. You can press the **I/O** button again to change the IN/OUT point. Use the **▶** and **◀/▶** buttons to find the location in the track where you want to set each point.

## 2-Names and Functions of Parts

For details, see “Using loop playback (standard mode)” on page 68 and “Using loop playback with the playlist” on page 69.

### Left side panel

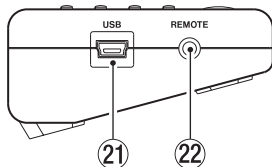

**21 USB port**

Use this port to connect the unit to a computer using the included USB cable. (See “Connecting with a computer” on page 43.)

**22 REMOTE jack**

Connect a TASCAM RC-3F foot switch (sold separately), which is designed for use with this unit, to this 2.5-mm TRS jack.

### Right side panel

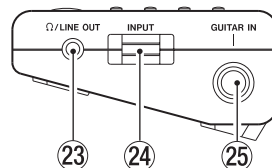

**23 Ω /LINE OUT jack**

Connect headphones here or connect a stereo mini-jack cable from here to the line input jack of another audio device.

**24 INPUT volume**

Use to adjust the input level of the **GUITAR IN** jack signal.

**25 GUITAR IN jack**

Use this standard mono 6.3-mm (1/4”) jack to connect a guitar or bass.

## 2-Names and Functions of Parts

### Rear panel

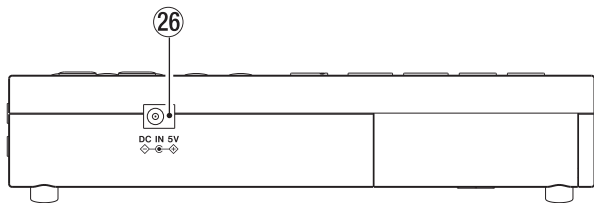

#### 26 DC IN 5V jack

Connect a TASCAM PS-P520 AC adaptor (sold separately), which is designed for the power requirements of this unit.

### Bottom panel

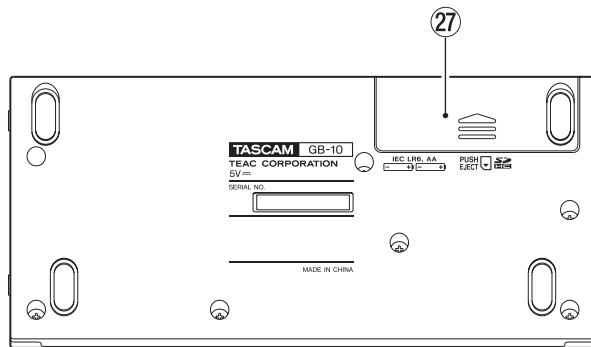

#### 27 Battery compartment cover

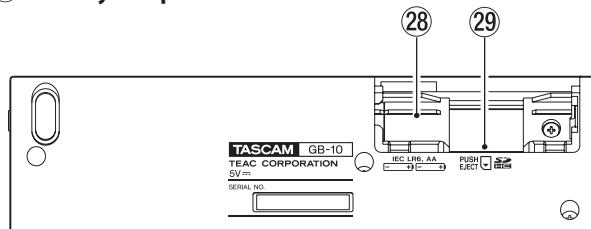

## 2-Names and Functions of Parts

### 28 Battery compartment

Install batteries (2 AA) in this compartment to power the unit. (See “Using AA batteries” on page 40.)

### 29 SD card slot

Use to insert and remove SD cards. (See “Inserting and removing SD cards” on page 37.)

## Home Screen

The following information appears on the display when the Home Screen is open.

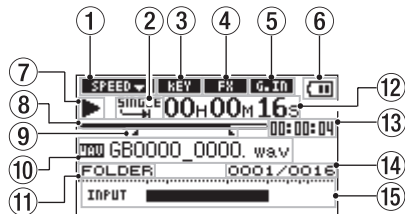

### 1 Playback speed status

Depending on the playback speed setting, the icon appears as follows.

	Normal playback speed
	110-150% speed
	50-90% speed

### 2 Loop playback/repeat playback setting status

Depending on the setting, the icon appears as follows.

- : Single playback
- : Repeat playback of one song
- : Repeat playback of all songs
- : Loop playback

### 3 Key adjustment status

This shows whether key adjustment is ON or OFF.

- : Key adjustment OFF
- : Key adjustment ON

### 4 Effect ON/OFF status

This shows whether the effects are ON or OFF.

- : Built-in effects OFF
- : Built-in effects ON

### 5 GUITAR input ON/OFF status



This shows whether input through the GUITAR IN jack is ON or OFF.

- : GUITAR input OFF
- : GUITAR input ON

## 2–Names and Functions of Parts

### ⑥ Power supply status

When the unit is being operated on battery power, a battery (  ) icon is shown.

The amount of remaining battery charge is shown by the number of bars in the icon ( , ,  ).

When almost no battery charge is remaining, the empty battery (  ) icon blinks. When this happens, the unit will soon switch to standby.







When using a TASCAM PS-P520 AC adaptor (sold separately) or USB bus power, the AC (  ) icon is shown.

### NOTE

Even when some battery charge is remaining, a “Battery Low” pop-up message might appear if you try to start recording or another operation that requires a lot of power.

### ⑦ Recorder operation status

Depending on the recorder operation status, one of the following icons appears.

	Stopped
	Paused
	Playing back
	Searching forward
	Searching backward
	Skipping to the beginning of the next file
	Skipping to the beginning of the previous file

### ⑧ Playback position

This bar shows the current playback position. As playback proceeds, the darkened bar extends from the left.

### ⑨ Playback interval

This shows the loop playback IN point (starting point) and OUT point (ending point) settings.

When a starting point is set, the “  ” icon appears at the corresponding position beneath the playback position bar.

When an ending point is set, the “  ” icon appears at the corresponding position beneath the playback position bar.

### ⑩ File information

This shows the name of the file being played back. If an MP3 file has ID3 tag information, that information is shown instead.

### NOTE

ID3 tag information is title and artist name information that can be stored in an MP3 file.

### ⑪ Playback area

This shows the currently selected playback area.

ALL All files in the MUSIC folder

FOLDER All files in the selected folder

P.LIST All files added to the playlist



## 2-Names and Functions of Parts

### ⑫ Elapsed time

This shows the elapsed time of the currently playing file (hours: minutes: seconds).

### ⑬ Remaining time

This shows the remaining time of the currently playing file (hours: minutes: seconds).

### ⑭ Playback file number/total number of files

This shows the total number of files in the playback area and the current file number.

### ⑮ Level meter

When **G.IN** is ON ( **G-IN** ), this shows the volume level of the input signals.

If the input level becomes too high, an indicator appears briefly at the right end of the meter.

When **G.IN** is OFF ( **G-MD** ), "OFF" appears here.

## Recording screen

When recording or when in recording standby, the screen appears as follows.

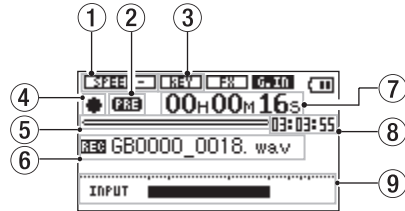

### ① Playback speed status

Depending on the playback speed setting, the icon appears as follows. The recording speed, however, cannot be changed.

	Normal playback speed
	110-150% speed
	50-90% speed

### ② Prerecord or auto record function status

When prerecording is enabled and the unit is in recording standby, "PRE" ( **PRE** ) appears here.

When the auto record function is enabled and the unit is recording, "A.REC" ( **A.REC** ) appears here.

## 2–Names and Functions of Parts



### ③ Key adjustment status

This shows whether key adjustment is ON or OFF. Key adjustment is disabled during recording

 : Key adjustment OFF

### ④ Recorder operation status

Depending on the recorder operation status, one of the following icons appears.

	Recording standby
	Paused
	Recording

### ⑤ Recording capacity

This shows the amount of the current SD card's total capacity that is used. As the amount of remaining capacity decreases, the darkened bar extends from the left.

### ⑥ File name

This shows the name of the file that is being recorded.

### ⑦ Elapsed recording time

This shows the elapsed time of the file being recorded (hours: minutes: seconds).

### ⑧ Remaining recording time

This shows the remaining amount of recording time available (hours: minutes: seconds) on the current SD card

### ⑨ Level meter

When **G.IN** is ON (  ), this shows the volume level of the input signals.

When **G.IN** is OFF (  ), "OFF" appears here.

---

## Menu structure

---

Press the **MENU** button to open the MENU screen. The menu contains the following items

Menu item	Function	Pages
INFORMATION	View information about files, the SD card and the system.	See on page 84.
PLAYLIST	Edit the playlist.	See on page 63.
PLAY MODE	Make playback interval and repeat playback settings.	See on page 60.
AUTO REC	Make automatic recording function settings.	See on page 48.
DIVIDE	Divide a file.	See on page 50.
FILE NAME	Make file name settings.	See on page 82.
FOOT SW	Make settings related to using a foot switch as a remote control.	See on page 83.
SETUP	Make various unit settings.	See on page 80.

### Using the menu

This example shows how to use the menu to change the repeat function.

1. Press the **MENU** button to open the **MENU** screen.

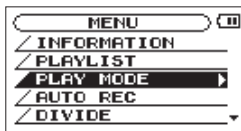

2. Use the **▲/BROWSE** and **▼/↵** buttons to select the desired menu item, and press the **▶** button or **▶▶|** button to open that setting screen.

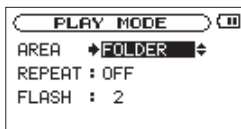

3. Use the **▲/BROWSE** and **▼/↵** buttons to select the desired setting item. (When selected, the “:” becomes “->” and the setting value appears as light letters on a dark background.)

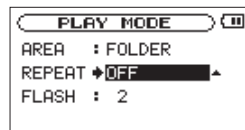

4. Use the **VALUE (+/-)** buttons to change the setting.

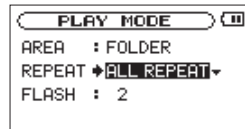

5. Repeat steps 3 and 4 as necessary for the other items.
6. Press the **MENU** button to return to the **MENU** screen. Press the **HOME** button to return to the Home Screen.

## 2—Names and Functions of Parts

### Basic operations

Use the following buttons to use the setting screens.

#### **MENU button**

Press to open the **MENU** screen. Press when the **MENU** screen is open to return to the Home Screen.

#### **HOME button**

When any of the setting screens is open, press the **HOME** button to return to the Home Screen.

#### **▶ button**

Use this button to move from the **MENU** screen to the selected setting screen, and to select “YES” on a confirmation pop-up message.

#### **▶▶ button**

Use this button to move from the **MENU** screen to the selected setting screen, to move the cursor (change the highlighted item) right on a setting screen and to open a folder on the **BROWSE** screen.

#### **◀◀ button**

Use this button to move the cursor (change the highlighted item) left on a setting screen and to close the open folder on the **BROWSE** screen.

#### **▲/BROWSE and ▼/↵ buttons**

Use this button to move the cursor (change the highlighted item) and to change the value of the selected item.

#### **VALUE (+/-) buttons**

Use to change value of the selected item.

#### **RECORD [●] button**

On the **DIVIDE** screen, use to execute the division of a file.

#### **⏻ / I [■] Button**

Use to respond “NO” to a pop-up confirmation message.

Use this also to return from the **FILE INFORMATION** pop-up message when using the browse function.

## Inserting and removing SD cards

### Inserting an SD card

The SD card slot is inside the battery compartment on the bottom of the case. Insert the SD card here.

#### NOTE

An SD card is already in the unit when it is purchased. You can use this SD card as is for recording and playback. There is no need to reinsert it.

- 1. Remove the battery compartment cover. If there are batteries in the compartment, confirm that the unit power is OFF and then remove them.**

- 2. Insert the SD card into the SD card slot in the back of the battery compartment in the direction shown in the illustration until it clicks into the place.**

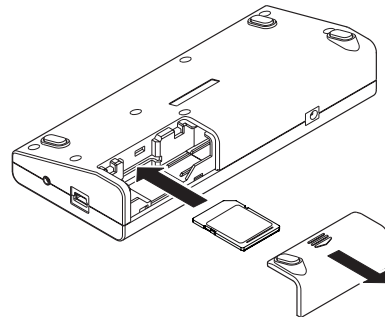

- 3. Insert the card and close the cover.**

If you are using batteries, insert them first before closing the cover

## 3-Preparation

### Removing an SD card

Press the inserted SD card in slightly to eject it.

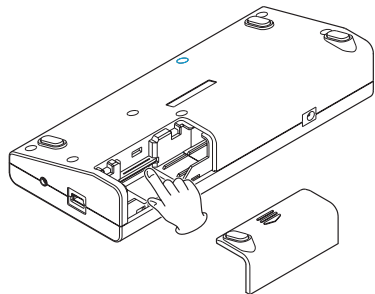

#### CAUTION

- Do not remove the SD card from the unit when it is connected to a computer by USB.
- SD cards that meet SD/SDHC standards can be used with this unit.
- A list of SD cards that have been verified to work with this unit is posted on the TASCAM website (<http://www.tascam.com/>).

### Preparing an SD card for use

To use an SD card with this unit, you must format it by using this unit first.

1. **Confirm that an SD card is inserted, and press and hold the  $\text{⏻}$  /  $\text{[■]}$  button on the top panel of the unit to turn the power ON.**
2. **If a new card or a card that was formatted by a different device has been inserted in the unit, the following pop-up message appears.**

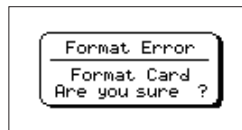

3. **Press the  $\blacktriangleright$  button to start formatting.**

**Remove the SD card if you do not wish to format it.**

#### CAUTION

Formatting will erase all the data on the card.

4. **After formatting completes, the Home Screen opens.**

**You can also reformat a card with this unit at any time.**

### CAUTION

When formatting, use a TASCAM PS-P520 AC adaptor (sold separately), USB bus power or confirm that the batteries have sufficient remaining power.

### Special cases

- If you insert an SD card that has been formatted by a device other than another GB-10, the **FORMAT ERROR** screen will appear. In this case, format the card to use it with this unit. SD cards that have been formatted by a TASCAM DR series device, however, are compatible with this model.
- If the system file or another important file has been accidentally erased from the SD card when accessing it from a computer, the following pop-up screen appears.

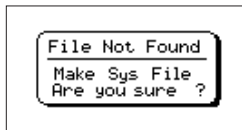

In this case, press the ► button to format the card again.

### Card write protection

SD cards have write-protection switches that prevent new data from being written to them.

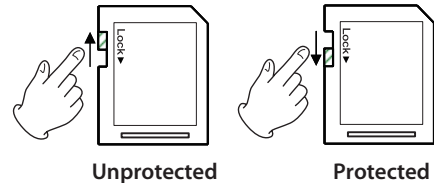

If you slide the protect switch to the “LOCK” position, file recording and editing will not be possible. Move the switch to the unlocked position in order to record, erase and otherwise edit data on the card.

## 3-Preparation

### Powering the unit

This unit can be powered by two AA batteries, USB bus power or a TASCAM PS-P520 AC adaptor (sold separately).

This unit can use either alkaline or nickel-metal hydride (NiMH) batteries.

### Using AA batteries

As described in the “Inserting and removing SD cards” section above, this unit has a battery compartment in the bottom. Insert 2 AA batteries into this compartment, aligning them correctly with the plus/minus indications inside, and then close the compartment cover.

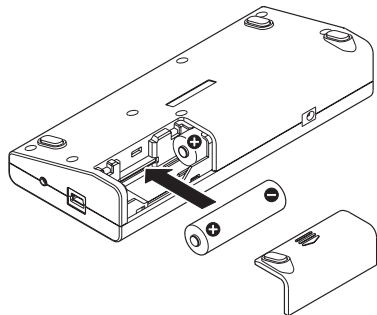

When using AA batteries, set the type of battery in order to allow the unit to accurately show the amount of power remaining and determine whether enough power is available for proper operation. (See “Setting the battery type” on page 80.)

### CAUTION

- Manganese batteries cannot be used with this unit.
- This unit cannot recharge Ni-MH batteries. Use a commercially-available recharger.
- The included alkaline batteries are provided for confirming the operation of the unit and might not last very long.

### Using USB bus power

Connect the unit with a computer using the included USB cable as shown in the illustration below.

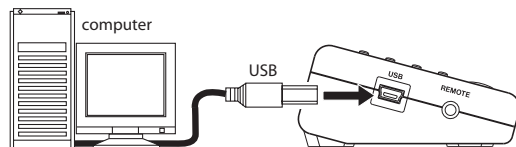

The USB SELECT screen appears if the power is ON when you make the USB connection or if you turn the power ON after making the USB connection. This screen allows you to set



whether to use USB bus power (“BUS POWER”) or to connect the unit’s storage to the computer (“STORAGE”).



Use the ▲/**BROWSE** button or ▼/↙ button to select “BUS POWER” and press the ► button to provide power from the computer USB port and open the Home Screen.

### CAUTION

Connect this unit and the computer directly. Operation using a USB hub cannot be assured.

### NOTE

If you connect to a computer by USB, power will be supplied from the USB bus even if batteries are also in the unit.

### Using an AC adaptor (sold separately)

Connect a TASCAM PS-P520 AC adaptor (sold separately), which is designed for the power requirements of this unit, to the DC IN 5V jack as shown in the illustration.

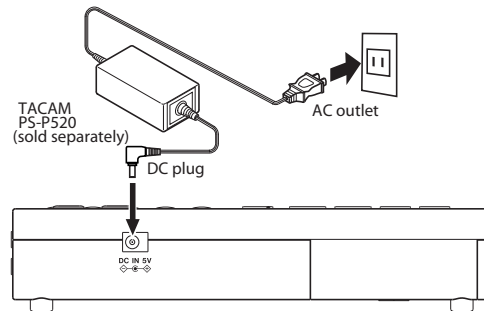

### CAUTION

Never use any adaptor other than the TASCAM PS-P520 AC adaptor (sold separately), because it is designed for the power requirements of this unit. Use of a different adaptor could cause malfunction, fire or electric shock.

### NOTE

If batteries are installed and the AC adaptor is connected, power will be supplied from the AC adaptor.

## 3-Preparation

### Startup and shutdown

#### CAUTION

Turn the volume of any monitoring system that is connected to this unit down completely before turning the unit's power ON or putting it into standby. Do not wear connected headphones when turning the unit's power ON or putting it into standby. Failure to follow these precautions could cause noise, which might damage speakers or harm your hearing.

#### Turning the power on

When the unit is in standby mode, press and hold the  $\phi / I$  [■] button until the "TASCAM GB-10" startup screen opens.

The Home Screen opens after the unit completes startup.

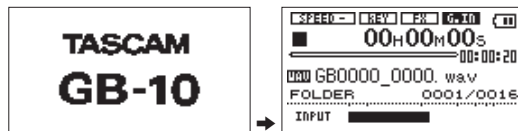
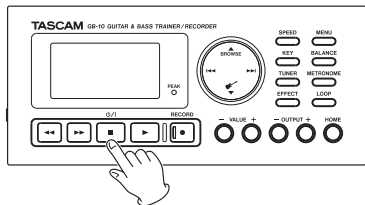

[startup screen]

[Home Screen]

#### Setting the power to standby

When the power is ON, press and hold the  $\phi / I$  [■] button until the "GUITAR & BASS TRAINER/RECORDER" screen appears.



## Connecting monitoring equipment

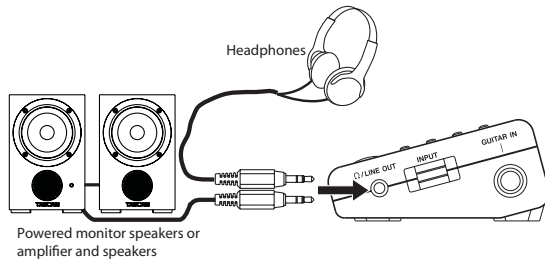

Connect headphones or a monitoring system (such as powered speakers or an amplifier and speakers) to this unit's  $\Omega$  /LINE OUT jack.

### CAUTION

Before connecting headphones, use the **OUTPUT (-)** button to minimize the volume. Failure to do so could cause the sudden output of loud sounds, which might lead to hearing damage or other harm.

## Connecting with a computer

By connecting this unit with a computer, you can transfer (copy) audio files (WAV or MP3 format) on the computer to the SD card in the unit, as well as erase files and work with folders on the card from the computer.

Use the included USB cable to connect the USB port of this unit to a USB port on the computer.

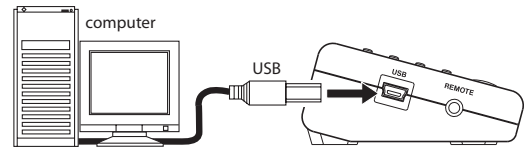

When connected, the "USB SELECT" pop-up screen appears on the unit.



To exchange data with the computer, use the  $\blacktriangle$ /BROWSE or  $\blacktriangledown$ / button to select "STORAGE" and press the  $\blacktriangleright$  button. "USB connected" pop-up screen appears on the screen. (Select "BUS POWER" to power the unit from the computer USB bus.)

## 4-Connecting

This unit appears on the computer screen as an external drive named GB-10.



The GB-10 drive contains **MUSIC** and **UTILITY** folders.

### Disconnecting from a computer

After using the correct procedures to dismantle the “GB-10” drive from your computer, disconnect the USB cable. The unit should automatically turn off.

Please refer to the operation manual for your computer system for instructions about the correct procedures for dismantling an external drive.

## Connecting a guitar or a bass

You can directly connect a guitar or a bass to the **GUITAR IN** jack (standard mono) on the right side panel of the unit.

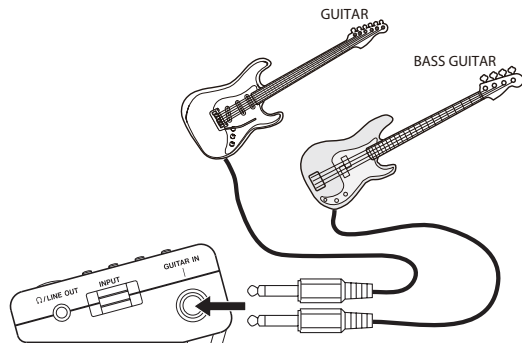

### NOTE

You can apply the built-in effects to sound input by the connected instrument and play along to a song playing back on the unit or its metronome.

This unit can record a performance played on a guitar or a bass that is connected to its **GUITAR IN** jack. The audio file format used for recording is always 44.1 kHz, 16-bit WAV.

In addition, this unit can also mix the input signal and an audio file that is playing back and record both together (overdubbing).

---

## Setting the location where recorded files are saved

---

You can set the location where recorded files are saved. (See “Folder operations” on page 55.)

If you do not set a destination, files will be saved directly in the **MUSIC** folder.

---

## Adjusting the input level

---

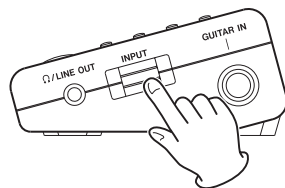

You can adjust the level of the guitar/bass input.

Use the **INPUT** volume control on the right side panel to adjust the input level of the **GUITAR IN** jack.



The **PEAK** indicator to the right of the display lights red just before the recording level begins to distort. Play the connected guitar or bass at the loudest level that will occur during recording, and set the **INPUT** level as high as possible without making the **PEAK** indicator light red.

### CAUTION

In order to hear the sound that you are recording through the **GUITAR IN** jack, the G.IN icon (  ) must appear highlighted (lights letters on a dark background). If it is not highlighted, press the  button to enable it.

## 5-Recording

### Recording

Before following these procedures, adjust the input level and open the Home Screen.

1. Press the **RECORD** [●] button briefly to start ordinary recording.

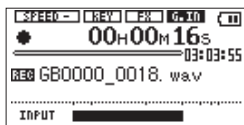

When recording starts, the **RECORD** [●] button indicator lights and the display shows the elapsed and remaining recording times.

Press and hold the **RECORD** [●] button to enable the pre-record function and put the unit into recording standby. The **RECORD** [●] button indicator blinks when in recording standby. (See “Recording a few seconds before pushing the record button (pre-recording)” on page 46.)

2. Press the  $\phi$  / I [■] button to stop recording.

To pause recording, press the **RECORD** [●] button. To resume recording to the same file, press the **RECORD** [●] button again.

Press the  $\phi$  / I [■] button after pausing to complete the creation of an audio file with the music recorded up to the moment that recording was paused.

### Recording a few seconds before pushing the record button (pre-recording)

The unit can capture up to 2 seconds of input signal during recording standby, allowing recording to start before the **RECORD** [●] button is pushed.

1. Press and hold the **RECORD** [●] button briefly to start recording standby. The **RECORD** [●] button indicator blinks, and the **PRE** (PRE) icon appears on the display.
2. Press the **RECORD** [●] button again briefly to start recording. Input signal is recorded starting up to 2 seconds before the button was pushed.

The **RECORD** [●] button indicator lights when recording.

3. Press the  $\phi$  / I [■] button to stop recording.

To pause recording, press the **RECORD** [●] button. To resume recording to the same file, press the **RECORD** [●] button again.

Press the  $\phi$  / I [■] button after pausing to complete the creation of an audio file with the music recorded up to the moment that recording was paused.

### TIP

Use this function in combination with the auto-recording function to record without missing the beginning of a performance.

### NOTE

If the unit was put into recording standby less than 2 seconds before this function is used, recording will start from the time when recording standby was enabled.

---

## Recording the input sound with the playback sound (overdubbing)

---

You can combine the input signal with the signal from an already recorded file being played back to record a new file. For example, you could record a new guitar part over an existing track.

### NOTE

- When overdubbing, You cannot use the auto-record or manual file incrementation functions.

- You cannot pause during overdubbing. (The **RECORD** [●] button does not respond if pushed.)

### TIP

Using the overdubbing function, you can record over the same file multiple times, allowing you to use this unit as a simple multitrack recorder.

When overdubbing multiple guitar solos, for example, keep the guitar input off until just before the solo to avoid recording unnecessary noise. Turn it on to record the solo, and turn it off again when done.



---

## Overdubbing

1. Use the **◀◀** button, **▶▶** button or the **BROWSE** screen to select the file that you want to overdub.
2. Press the **▶** button to start playback and begin playing the instrument. Check the balance between the levels of the playback and instrument sounds.
3. Use the **INPUT** volume to adjust the input volume level so that the **PEAK** indicator does not light. Press the **BALANCE** button to show the **BALANCE** item, and use the **VALUE (+/-)** buttons to adjust the level of the playback sound. The range is from "0" (minimum) to "20" (maximum), and the default value is "20".

## 5-Recording

### NOTE

The **BALANCE** setting only affects the volume when **G.IN** is ON (  ). When **G.IN** is OFF (  ), changing the **BALANCE** value has no effect on the volume.

4. Press the **▶** button while pressing and holding the **RECORD**  button to begin overdubbing.

### CAUTION

If you press and hold the **RECORD**  button long, the unit will be put in recording standby with the pre-record function enabled, and overdubbing will not be possible.

5. When overdubbing starts, the **RECORD**  button indicator lights, and the elapsed and remaining recording times are shown on the recording screen. In addition, the name of the file being played back is shown next to the play icon and above the name of the file being recorded.

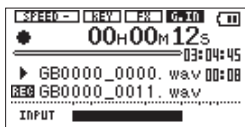

If no file that can be played back has been selected, the following pop-up message appears.



6. Press the  /  button to stop recording.

## Starting and pausing recording automatically (AUTO REC)

This unit can be set to automatically start and pause recording in response to the level of the input signal.

1. Press the **MENU** button to open the **MENU** screen.
2. Use the **▲/BROWSE** and **▼/↵** buttons to select the **AUTO REC** menu item, and press the **▶** or **▶▶** button to open the **AUTO REC** screen.

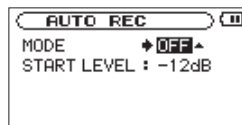

3. Use the **▲/BROWSE** and **▼/↵** buttons to select the **MODE** item.



4. Use the VALUE (+/-) buttons to set it to “ON”.

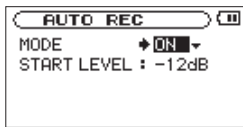

5. Press the ▲/BROWSE or ▼/ button to select the “START LEVEL” item.

6. Use the VALUE (+/-) buttons to set the input signal detection level to “-6dB”, “-12dB” (default value), “-24dB” or “-48dB”.

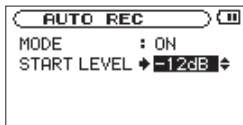

7. After completing the setting, press the HOME button to return to the Home Screen.

8. Press the RECORD [●] button to start recording standby and RECORD [●] button indicator blinks.

Press and hold the RECORD [●] button to enable the pre-record function and put the unit into recording standby.

Recording starts automatically when the input signal level exceeds the detection level set using the “START LEVEL” item.

Recording stops automatically and the unit returns to recording standby when the input signal level stays below the detection level set using the “START LEVEL” item for five or more seconds and RECORD [●] indicator blinks.

**TIP**

Use this function in combination with the pre-recording function to record without missing the beginning of a performance.

**NOTE**

When “AUTO REC” is ON, unlike usual, pressing the RECORD [●] button briefly does not start recording, but does put the unit into recording standby.

9. You can press the [ ] button if you want to stop a recording that has started automatically.

**CAUTION**

When overdubbing, the auto-recording function cannot be used.

## 5-Recording

---

### Track incrementation

---

You can start recording to a new file without interruption manually. If a file reaches the maximum size (2GB), the unit will also automatically start recording to a new file. In both cases, the original file is saved and no gap occurs in the recording.

---

### Manual track incrementation during recording

---

At any time during recording, you can manually start a new file and continue recording easily.

#### 1. Press the **▶▶** button during recording.

##### CAUTION

- A new file cannot be created if the total number of files and folders would exceed 5000.
- Files shorter than two seconds cannot be created.
- If the name of a newly created file would be the same as that of an existing file, the number at the end of the name is increased to give the new file a unique name.
- When overdubbing, the track incrementation function cannot be used.

##### NOTE

When a new file is created, the number at the end of the name is increased.

---

### Automatic track incrementation by file size

If a file reaches the maximum size (2GB) during recording, the unit will automatically start recording to a new file. The original file is saved and no gap occurs in the recording.

##### CAUTION

A new file cannot be created if the total number of files and folders would exceed 5000.

##### NOTE

If the recording time is 24 hours or more, it will be displayed as 23:59:59.

---

### Dividing files (DIVIDE)

---

You can split a recorded file into two files at any position you like.

1. Use the **◀◀** button, **▶▶** button, or **BROWSE** screen to select the file that you want to divide.
2. Press the **MENU** button to open the **MENU** screen.

3. Use the ▲/BROWSE and ▼/ buttons to select the “DIVIDE” menu item, and press the ► button or ►► button to open the DIVIDE screen.

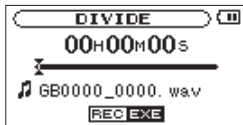

4. Use the ◀◀ and ▶▶ button to determine where the file will be divided, and press the RECORD [●] button.

The following pop-up message appears.

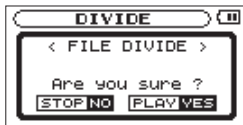

5. Press the ► button to divide the file.

Press the ⏻/ I [■] button to cancel division and return to the DIVIDE screen.

#### NOTE

- When the DIVIDE screen is open, you can press the ► button and set the divide position while playing the track.
- After dividing a file, two new files with “\_a” and “\_b” added to the end of the original file name are created. For example if the original filename is “GB0000\_0000.wav” then the new files will be named “GB0000\_0000\_a.wav” (the recording before the division point) and “GB0000\_0000\_b.wav” (the recording after the division point).

#### CAUTION

- MP3 files cannot be divided.
- Division is not possible if the SD card has insufficient open space.
- Division is not possible if the file name would become more than 200 characters long.
- Division is not possible if a file that already exists has the same name as the name that would be given to a new file created by division.

---

## Recording duration

---

The table below shows the approximate amount of recording time possible on SD/SDHC cards of different capacities.

	SD/SDHC card capacity			
	1GB	2GB	4GB	8GB
Approximate recording time (hours: minutes)	1 : 41	3 : 22	6 : 44	13 : 28

- The recording times shown above are estimates. They might differ depending on the SD/SDHC card being used.
- The recording times shown above are not continuous recording times, but rather they are the total possible recording times for the SD/SDHC card.
- This unit only records in 44.1 kHz, 16-bit WAV format.

# 6–Working with Files and Folders (BROWSE screen)

On the Browse Screen, you can view the contents of the “MUSIC” Folder, which contains the audio files on the SD card. On this screen, you can also play and erase selected audio files, create folders, add tracks to the playlist and so on. (See “Playlist” on page 63.)

## TIP

If you connect this unit with a computer by USB or connect the SD card directly with a computer, you can change the folder structure within the “MUSIC” Folder and erase files in it using the computer. Furthermore, you can change file names from the computer.

To open the BROWSE screen, from the Home Screen, press the ▲/BROWSE button.

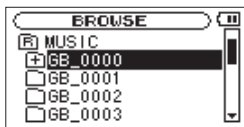

When you open the BROWSE screen, the contents of the folder that contains the file that was selected on the Home Screen are shown.

## BROWSE screen navigation

On the BROWSE screen, folders and music files appear in a hierarchical structure much like they would appear on a computer. Folders can only be used to two levels.

- Use the ▲/BROWSE and ▼/↵ buttons to select files and folders.
- When a folder is selected, press the ►| button to show the contents of that folder.
- When a file or folder is selected, press the ◀◀ key to exit the currently open folder and go to a higher level in the folder structure.
- When a file or folder is selected, press the ► key to open the pop-up window.

## Icons on the BROWSE screen

The icons that appear on the BROWSE Screen have the following meanings.

### MUSIC folder ( )

The MUSIC Folder is the highest (root) level folder in the hierarchy shown on the BROWSE Screen.

## 6–Working with Files and Folders (BROWSE screen)

### Audio file ( 🎵 )

This icon appears before the names of audio files.

### Folder ( ⊕ )

This icon shows folders that contain subfolders.

### Folder ( □ )

This icon shows folders that do not contain subfolders.

### Open folder ( 📁 )

The contents of the folder marked with this icon are currently shown on the screen.

---

## File operations

---

Select the desired audio file on the BROWSE screen, and press the ► button to open the following pop-up menu.

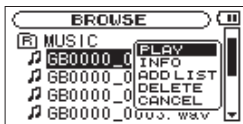

Use the ▲/BROWSE and ▼/◀ buttons to select the desired item, and press the ► button to execute one of the following operations.

### PLAY

Play the file and reopen the Home Screen. If the playback area is set to "FOLDER", the playback area becomes the folder that contains that file.

### INFO

Show information (date, time and size) about the selected file. Press the ► button again or press the ◂/|■ button to return to the BROWSE screen.

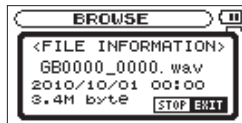

### ADD LIST

Add the selected file to the playlist. (See "Playlist" on page 63.)

### DELETE

A message appears to confirm that you want to delete the selected file. Press the ► button to delete the file and the ◂/|■ button to cancel deletion.



## 6-Working with Files and Folders (BROWSE screen)

### CANCEL

No operation is conducted on the selected file and the pop-up menu closes.

## Folder operations

Select the desired folder on the BROWSE screen, and press the ► button to open the following pop-up menu.

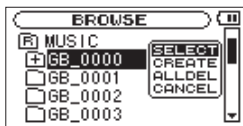

Use the ▲/BROWSE and ▼/ buttons to select the desired item, and press the ► button to execute one of the following operations.

### SELECT

Return to the Home Screen and select the first file in the folder. This folder becomes the new playback area regardless of the previous playback area setting. When recording, files are created in the folder selected using this operation.

### CREATE

A pop-up appears to confirm that you want to create a new folder.



Press the ► button to create a new folder, or press the ⏻ / I [■] button to cancel the operation.

However, if you try to create a new folder inside a second level subfolder the "Layer too Deep" message appears and the folder is not made.

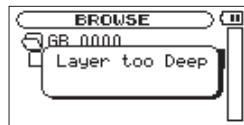

## 6–Working with Files and Folders (BROWSE screen)

### ALL DEL

A pop-up message appears to confirm that you want to delete all the files in the selected folder at once.



Press the ► button to erase the files, or press the ⏪/|■ button to cancel the operation.

### NOTE

You cannot erase read-only files or files that are not recognized by this unit.

### CANCEL

No operation is conducted and the selected folder is left as is.

### Delete the selected playback file (QUICK DELETE)

Use the following procedure to conveniently delete the currently selected playback file.

1. On the Home Screen, press and hold the ▲/BROWSE button to open the QUICK DELETE screen.
2. Press the ► button again to confirm deletion, or press the ⏪/|■ button to cancel.





When the Home Screen is open, use **▶**, **◀◀**, **▶▶** and other buttons to operate the unit in the same way you would use a CD player or other audio playback device.

When the Home Screen is not open, however, these buttons have different functions.

Before using the following procedures, insert an SD card that has been formatted by this unit and that contains audio files that the unit can playback.

## NOTE

SD cards that have been formatted by a TASCAM DR series device can also be used with this unit.

---

## Playback

When the unit is stopped, press the **▶** button to start playback.

## NOTE

- Only files in the playback area can be played.
- You can also choose files for playback by name on the **BROWSE** screen.

---

## Stopping playback

When the Home Screen is open and a track is playing back, press the **⏸** / **I** [■] button to stop playback at the current position (pause).

Press the **⏸** / **I** [■] button again to return to the beginning of the file.

---

## Selecting a file

During playback or when stopped, use the **◀◀** and **▶▶** buttons to select a file.

Press the **◀◀** button to skip to the previous file.

Press the **▶▶** button to skip to the next file.

Only files in the playback area can be played. (See “Using the PLAY MODE screen to set the playback area” on page 60.)

The song name, file number and other information for the currently playing file are shown on the display.

The “■” icon appears on the display when playback is stopped at the beginning of a track, and the “▮” icon appears when playback is stopped in the middle of a track (paused).

## 7-Playback

### Searching forward and backward

During playback or when stopped (or paused), press and hold the ◀◀/▶▶ button to search backward/forward. Release the button to return to the previous state.

Use the “CUE/REV SPEED” item on the SETUP screen to set the search speed. (See “System settings(SETUP)” on page 80.)

Press the ◀◀/▶▶ button briefly to search backward/forward to the beginning/end of the file.

Press the same button again briefly to change the search speed. The speed options are: x2, x5, x10, x20, x40 and x120.

#### NOTE

Searching backward/forward continues only until the beginning/end of the current file. Searching will not continue into the previous or next file even if you continue to hold the button.

### Adjusting the playback volume

Use the **OUTPUT (+/-)** buttons to adjust the volume level output from the Ω/LINE OUT jack. While being adjusted, the volume level is shown in a pop-up at the bottom of the display.



#### NOTE

If you turn the guitar input off, the playback level returns to its original level.

If the guitar input is on, and you have used the **BALANCE** button to lower the volume of the playback (“BALANCE”) to overdub an audio file, when you play back that file, the playback monitoring level will be lower than it was when recording. In this case, use the **BALANCE** button to set “BALANCE” to its maximum.

## Adjusting the balance between playback and input signals

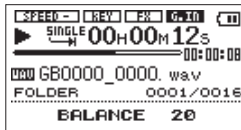

You can adjust the balance between the input sound of a connected guitar or bass being played and the playback sound of a file.

Use the **INPUT** volume to adjust the level of the input signal, and press the **BALANCE** button to open the “BALANCE” item and adjust the level of the playback signal.





Adjust the volume of the playback sound using the **VALUE** (+/-) buttons. The range is from “0” (minimum) to “20” (maximum), and the default value is “20”.



### NOTE

The **BALANCE** setting only affects the volume when **G.IN** is ON (  ). When **G.IN** is OFF(  ), changing the **BALANCE** value has no effect on the volume.

## Disabling the guitar input

When you want to listen to just the playback signal, you can disable the guitar input to prevent any unwanted noise.

If you want to disable the guitar input (**GUITAR IN** jack), press the  button when the Home Screen is open so that the **G.IN** icon appears as dark letters on a light background (  ).

Press the  button again to enable the guitar input. The **G.IN** icon appears as light letters on a dark background (  ) when input is enabled.

### NOTE

If you turn the guitar input off (  ), “[OFF]” appears in the level meter area.

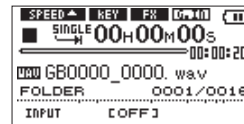

When the guitar input is off, the **BALANCE** setting is canceled and the playback level returns to its original setting.

# 8-Playback Area and Playlist

On the Home Screen, use the **◀◀** or **▶▶** button to select a file from the current “playback area” to play. You can set the playback area that includes the files that can be selected. If the card contains a large number of files, for example, setting a limited playback area can make file selection easier. On the **PLAY MODE** screen, you can set the playback area to all files, the current folder or the playlist. You can also use the **BROWSE** screen to set the desired folder as the playback area.

## NOTE

On the **BROWSE** screen, you can also choose any file on the card for playback regardless of the playback area setting.

---

## Using the **PLAY MODE** screen to set the playback area

---

Follow these procedures to set the playback area on the **PLAY MODE** screen.

1. Press the **MENU** button to open the **MENU** screen.
2. Use the **▲/BROWSE** and **▼/↵** button to select “**PLAY MODE**” and press the **▶** button or **▶▶** button to open the **PLAY MODE** screen.

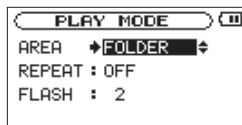

3. Select the “**AREA**” item so that its setting value appears as light letters on a dark background.
4. Use the **VALUE (+/-)** buttons to select one of the following playback areas.

### **ALL FILES**

Allow playback of all the files in the **MUSIC** folder on the SD card.

### **FOLDER**

Allow playback of all the files in the folder that contains the currently selected file.

### **PLAYLIST**

Allow playback of the files in the playlist. (See “Playlist” on page 63.)

If you select this, but there is no playlist defined, a “No **PLAYLIST**” pop-up appears.



Even if there is no playlist, you can still set the playback area to "PLAYLIST". Doing so, however, will cause the "No PLAYLIST" pop-up to appear every time you press the ◀◀ or ▶▶ button because you cannot change to another file.



## NOTE

The current playback area setting ("ALL," "FOLDER" or "P.LIST") is shown at the bottom left of the Home Screen.

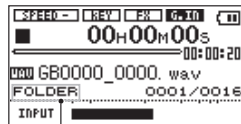

Playback area indication

## Selecting a folder for the playback area (1)

Regardless of the current playback area, if you select a folder on the Browse Screen, the playback area changes to the selected folder.

1. On the Home Screen, press the ▲/BROWSE button to open the BROWSE screen.

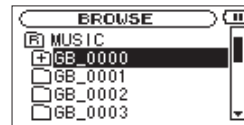

2. Use the ▲/BROWSE and ▼/SELECT buttons to select the desired folder (light on dark).

For instructions about using the BROWSE screen, see "BROWSE screen navigation" on page 53.

3. Press the ► button to open the pop-up menu shown below.

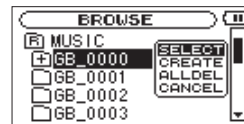

## 8-Playback Area and Playlist

Use the ▲/BROWSE and ▼/↵ buttons to choose the “SELECT”, and to press the ► button.

4. The Home Screen automatically reopens and the first file in that folder is selected. This folder becomes the playback area regardless of the previous playback area setting.

---

### Selecting a folder for the playback area (2)

---

If the playback area is set to “FOLDER” and you select a file on the BROWSE screen, the folder that contains the selected file becomes the playback area.

1. On the Home Screen, press the ▲/BROWSE button to open the BROWSE screen.

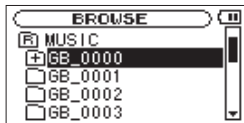

2. Use the ▲/BROWSE and ▼/↵ buttons to select the desired folder (light on dark).

3. press the ► button to show the contents of that folder.

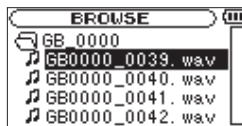

4. Use the ▲/BROWSE and ▼/↵ buttons to select the desired file (light on dark).

For instructions about using the BROWSE screen, see “BROWSE screen navigation” on page 53.

5. Press the ► button to open the pop-up menu shown below.



4. Use the ▲/BROWSE and ▼/↵ buttons to choose the “PLAY” (light on dark), and to press the ► button.

The Home Screen automatically reopens and that file starts playing back. Moreover, the folder that contains that file becomes the playback area regardless of the previous playback area setting.

## Playlist

You can make a playlist, which is a set of tracks for playback.

You can play just the tracks in your playlist by setting the “AREA” item to “PLAYLIST” on the PLAY MODE Screen.

In addition, when the playback area is set to “PLAYLIST”, loop playback has additional functions. (See “Using loop playback with the playlist” on page 69.)

### Adding files to the playlist

1. On the Home Screen, press the **▲/BROWSE** button to open the BROWSE screen.

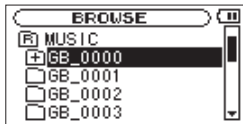

#### NOTE

For more information about the BROWSE screen, see Chapter 6 “Working with Files and Folders (BROWSE screen)” on page 53.

2. Select the file that you want to add to the playlist and press the **▶** button to open the following pop-up menu.



For more information about selecting files, see “BROWSE screen navigation” on page 53.

3. Select “ADD LIST”, and press the **▶** button to add that file to the playlist. The pop-up menu closes.
4. Repeat steps 2 and 3 as necessary.

Numbers are assigned to the files in the order that they are added to the list.

### Editing the playlist

You can view the playlist you have made on the PLAYLIST Screen. On this screen, you can also play files and edit the playlist

1. Press the **MENU** button to open the MENU screen.
2. Use the **▲/BROWSE** and **▼/↙** buttons to select the “PLAYLIST” menu item, and press the **▶** button to open the PLAYLIST screen.

## 8-Playback Area and Playlist

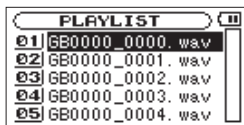

3. Use the ▲/BROWSE and ▼/↵ buttons to select the file that you want to edit, and press the ► button to open the pop-up menu.



4. Use the ▲/BROWSE and ▼/↵ buttons to select the desired item, and press the ► button to execute the operation.

### PLAY

Play the file and return to the Home Screen.

### ALL CLR

A confirmation message appears to confirm that you want to remove all the files from the playlist. Press the ► button to remove all the files or the ⏏/I[■] button to cancel this operation.

For this operation, it does not matter which track you select in step 3. All the files are removed from the playlist, but they are not erased from the SD card.



### DELETE

Remove the selected track from the playlist.

The file is removed from the playlist, but it is not erased from the SD card.

### CAUTION

No confirmation pop-up message appears before this operation.



## 8-Playback Area and Playlist

### MOVE

Select this to change the order of files in the playlist.

In addition to the file name, the file number also appears light on dark.

1. Use the ▲/BROWSE and ▼/↵ buttons to move the file to a different position in the playlist.

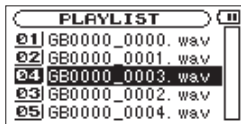

In the above example, the file in the 4th position has been moved to the 3rd position.

2. Press the ► button to complete the movement and return to the ordinary PLAYLIST screen. (The file number no longer appears light on dark.)



### CANCEL

No operation is conducted on the selected file, and the pop-up menu closes.

# 9-Special Playback (playback control function)

Using this unit's playback control functions, you can change the speed of playback without changing the pitch and vice versa. You can use these playback control functions for effective practice and learning new parts.

## Changing the speed

You can use the SPEED function to set the playback speed. This unit has a Variable Speed Audition (VSA) function, so even when playback speed is changed the pitch stays the same.

Press the **SPEED** button to show the SPEED setting area at the bottom of the Home Screen.

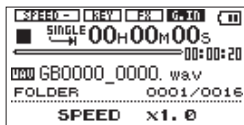

Use the **VALUE** (+/-) buttons to set the playback speed.

The speed can be set in a range between 50% ( $\times 0.5$ ) and 150% ( $\times 1.5$ ) of the original speed in 10% increments (default value: " $\times 1.0$ ").

When the "SPEED" is set from  $\times 0.5$ – $\times 0.9$ , the **SPEED** icon is shown, and when it is set from  $\times 1.1$ – $\times 1.5$ , the **SPEED** icon is shown.

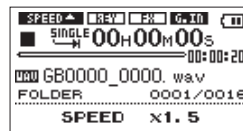
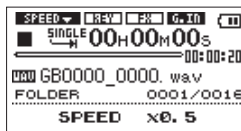

## Changing the key

You can use the KEY function to change the pitch of playback in semitone intervals (and the FINE TUNE function to change it in cents) without changing the speed.

Press the **KEY** button to show the KEY setting area at the bottom of the Home Screen on the display. Press the **KEY** button again to show the FINE TUNE setting area.

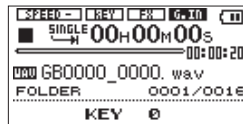

KEY can be set in a range of  $\pm 6$  semitones ( $\flat 6$ – $\sharp 6$ ). (The default value is "0".)

## 9-Special Playback (playback control function)

If you change the key to any value besides 0, the key change function turns ON and the KEY icon ( **KEY** ) appears on the Home Screen as light letters on a dark background.

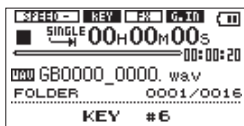

Use the FINE TUNE function to adjust the pitch by small amounts.

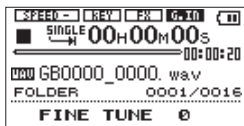

Use this to adjust the pitch up or down in cents (100 cents = 1 semitone) in a range of  $\pm 50$ . (The default value is "0".)

### NOTE

Even if you use the FINE TUNE function to adjust the key, as long as the KEY item setting is 0, the **KEY** icon will not appear as light letters on a dark background on the Home Screen.

## Jump back a set amount and continue playback (flashback)

During playback, press the ► button to use the flashback function. This jumps back a few seconds and continues playback.

Set the amount of time to go back using the "FLASH" item.

1. Press the MENU button to open the MENU screen.
2. Use the ▲/BROWSE and ▼/ buttons to select the "PLAY MODE" menu item.
3. Press the ► button or ►| button to open the PLAY MODE screen.
4. Use the ▲/BROWSE and ▼/ buttons to select "FLASH" (setting value appears light on dark).



5. Use the VALUE (+/-) buttons to set the flashback time in a range from 1–10 seconds, in one-second intervals. (Default value: "2" seconds)
6. After completing the setting, press the HOME button to return to the Home Screen.

# 10-Loop Playback/Repeat Playback/Single Track Playback

In ordinary playback mode, unless you do something to stop it, once playback starts, it will stop only when the end of the last file in the current playback area is reached. By making the settings and conducting the operations described in this chapter, however, you can also make the unit loop a section of a file that you choose, repeat all the files in the current playback area, play a single track repeatedly or play a single track once and stop.

## NOTE

Accurate assignment of IN (starting) and OUT (ending) points is not always possible for variable bit rate (VBR) MP3 files.

## Using loop playback (standard mode)

Use this function to continuously repeat playback (loop) part of a file that you select.



1. **During playback (or when paused), press the LOOP button to set the point where you want to start loop playback.**

The current position is set as the IN (starting) point.



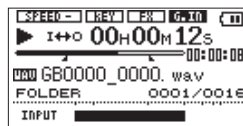

2. **Press the LOOP button at the point when you want loop playback to stop.**

The current position is set as the OUT (ending) point, and loop playback between the IN(starting) and OUT(ending) points begins.

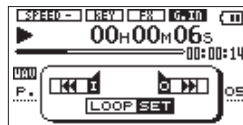

- The current positions of the IN (starting) and OUT (ending) points are shown by the  and  icons that appear below the playback position display bar on the Home Screen. During loop playback the  icon also appears.
  - To stop loop playback, press the **LOOP** button. This also clears the loop interval setting.
3. **Press and hold the LOOP button to open the “LOOP SET” pop-up.**



4. **Use the , ,  and  buttons to move the IN (starting) point to the desired position. Press the  button to save the IN (starting) point.**

# 10-Loop Playback/Repeat Playback/Single Track Playback

## NOTE

- When the LOOP SET pop-up window is open, press the ► button to playback, press ◂ / | [■] button to, and press the ◀◀ or ▶▶ button briefly to search the file.
  - Press and hold the ◀◀ or ▶▶ button to move the IN (starting) or OUT (ending) point. (This is not possible when there is no IN (starting) and OUT (ending) point.)
  - Press the ◂ / | [■] button during playback to pause, and press the HOME button when paused to returned to the Home Screen.
5. Next, use the same buttons to move the OUT(ending) point to the desired position, and press the ►▶ button to save the OUT(ending) point.

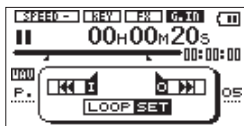

## NOTE

- Use the ◀◀ and ▶▶ buttons to switch between IN (starting) and OUT (ending) points.

6. Press the LOOP button briefly to start loop playback.

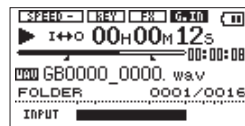

## Using loop playback with the playlist

When the playback area is set to playlist, up to 5 loops with distinct IN (starting) and OUT (ending) points can be set per file.

Follow the procedures below to set and play back loops of desired intervals in a file.

Loop settings for a file are saved until it is removed from the playlist.

1. Press the LOOP button to show the LOOP setting area at the bottom of the display. The word "LOOP" is followed by a number. Use the VALUE (+/-) buttons to set the number to 1-5.

# 10-Loop Playback/Repeat Playback/Single Track Playback

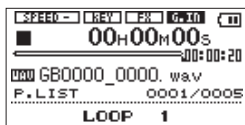

2. Press and hold the **LOOP** button to open the "LOOP SET" pop-up.

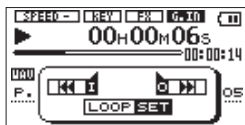

3. Use the **▶**, **◀◀**, **▶▶** and **⏸** / **[■]** buttons to move the **IN(starting)** point to the desired position. Press the **◀◀** button to save the **IN(starting)** point.

## NOTE

- When the **LOOP SET** pop-up window is open, press the **▶** button to playback, press **⏸** / **[■]** button to, and press the **◀◀** or **▶▶** button briefly to search the file.
- Press and hold the **◀◀** or **▶▶** button to move the **IN** (starting) or **OUT** (ending) point. (This is not possible when there is no **IN** (starting) and **OUT** (ending) point.)

- Press the **⏸** / **[■]** button during playback to pause, and press the **HOME** button when paused to returned to the Home Screen.
4. Next, use the same buttons to move the **OUT(ending)** point to the desired position, and press the **▶▶** button to save the **OUT(ending)** point.

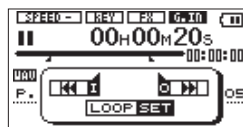

## NOTE

Use the **◀◀** and **▶▶** buttons to switch between **IN** (starting) and **OUT** (ending) points.

5. Press the **LOOP** button briefly to start loop playback.

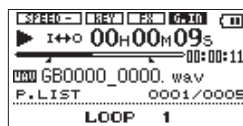

## Turning loop playback on and off

Press the **LOOP** button briefly to turn loop playback **ON** or **OFF**.

# 10-Loop Playback/Repeat Playback/Single Track Playback

When you want to restart loop playback, press the **LOOP** button briefly to start loop playback of the last used loop.

In the LOOP setting area shown at the bottom of the display, the word “LOOP” is followed by a number, which shows the current loop. Use the **VALUE (+/-)** buttons to change the loop number. During loop playback, you can change this number to start loop playback of a different loop if the loop assigned to that number has IN (starting) and OUT (ending) points set.

## Repeat and single track playback

You can repeatedly play back the current file (one file) or multiple files within the designated playback area. You can also play just one file.

1. Press the **MENU** button to open the **MENU** screen.
2. Use the **▲/BROWSE** and **▼ / ↙** buttons to select “PLAY MODE” and press the **▶** button or **▶▶** button.

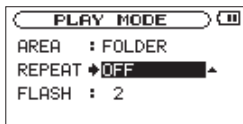

3. Use the **▲/BROWSE** and **▼ / ↙** buttons to select the “REPEAT” item, and use the **VALUE (+/-)** buttons to set

the playback mode.

### OFF(default)

Play all tracks in the playback area in sequence. (This is the ordinary playback mode.)

### SINGLE

Play one file without repeating.

The  icon appears on the Home Screen.

### 1 REPEAT

Play the currently playing file repeatedly.

The  icon appears on the Home Screen.

### ALL REPEAT

Play all the files in the selected playback area repeatedly.

The  icon appears on the Home Screen.

### NOTE

If you start loop playback, the REPEAT item automatically switches to OFF if it is in a different mode.

# 11-Transferring songs to and from a computer

You can transfer audio files from a computer by USB, and play them back for practice, to learn new parts and to overdub. Moreover, this unit can play back MP3 (32–320 kbps, 44.1 kHz) and WAV (44.1 kHz, 16/24-bit) audio file formats.

## NOTE

Instead of using USB to connect this unit and a computer, you can also conduct the same operations by removing the SD card from this unit and connecting it directly to a computer that has a built-in SD card slot or by using a card reader.

## Preparing audio files on a computer

Use the abilities of your computer OS or a software application to copy music files from a CD or other source to your computer.

When copying files to your computer, choose file types that this unit can handle (the MP3 and WAV file types listed above).

## Copying audio files from a computer

1. **Connect the unit to the computer.** (See “Connecting with a computer” on page 43.)
2. **Click the GB-10 drive that appears on the computer to open it, revealing UTILITY and MUSIC folders.**
3. **Drag-and-drop the desired audio files from the computer to the MUSIC folder to copy those files to the SD card.**

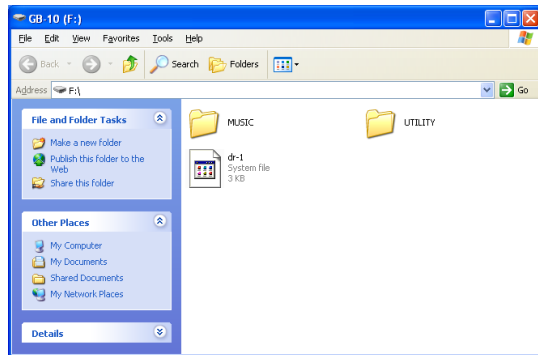



# Transferring songs to and from a computer

4. After you finish copying files and closing the connection with the unit SD card from the computer, disconnect the USB cable. (Please refer to the operation manual for your computer system for instructions about the correct procedures for dismounting an external drive.) The unit will automatically turn off.

## TIP

You can also manage the contents of the MUSIC folder on an SD Card from a computer.

You can create up to two levels of sub-folders inside the MUSIC folder. Since you can set the unit to only play the contents of a specific folder, you can conveniently organize tracks into musical categories and artists. (See “Folder operations” on page 55.)

Name the sub-folders and music files as you like, and these names will appear on the unit’s display.

## Transferring audio files to a computer

1. Click the GB-10 drive that appears on the computer to open it, revealing UTILITY and MUSIC folders.
2. Open the MUSIC folder, and drag and drop the files that you want to copy to the desired location on the computer.

## NOTE

This unit does not have an internal clock. For this reason, files created by this unit will always have the same fixed times for their creation and modification (EX : 2010/10/01 00:00:00). As a result, when a list of the files is viewed on a computer, arranging them in order of date and time will probably not show them in the order recorded.

# 12-Using the built-in effects

This unit has built-in effects that can be applied to the input signal during both practice and recording.

## Turning the effects ON and OFF



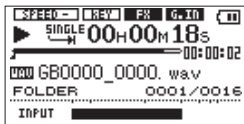

Press the **EFFECT** button briefly to turn the effects ON or OFF. When ON, the effect last set on the EFFECT Screen becomes active, and the FX icon (  ) appears as light letters on a dark background.

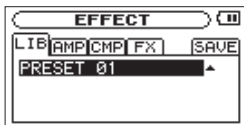

## Setting the effect

Press and hold the **EFFECT** button to open the EFFECT screen.



The EFFECT screen has five tabs: LIB, AMP, CMP, FX and SAVE. Use the  and  buttons to move between these tabs. When the "LIB" tab is open, you can press the  button to move to the SAVE tab, and when the SAVE tab is open, you can press the  button to open the LIB tab.



### LIB tab

Use the **VALUE** (+/-) buttons to select one of the settings saved in the effects library. There are 10 factory presets (PRESET 01–10) and 10 user settings (USER 01–10).

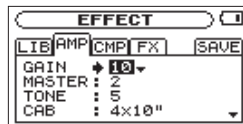
### AMP tab



Make guitar/bass amp simulator settings on this tab.

Use the /**BROWSE** and  buttons to select an item, and use the **VALUE** (+/-) buttons to change the setting.

### GAIN

Adjust the gain level.

### MASTER

Set the master volume.

## 12-Using the built-in effects

### TONE

Set the tone.

### CAB

Set the amplifier cabinet size.

The values shown indicate the number of speakers and the speaker diameter simulated.

For example, "4x10" indicates four 10-inch speakers.

### REVERB

Adjust the volume of the reverberation.

### CMP tab

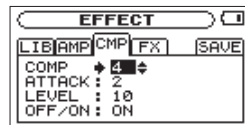

Make compressor settings on this tab.

Use the ▲/BROWSE and ▼/↵ buttons to select an item, and use the VALUE (+/-) buttons to change the setting.

### COMP

Adjust the amount of compression. This makes the volume level of the input sound more consistent and increases sustain.

### ATTACK

Set how quickly the compressor starts taking effect. The higher the value is, the longer it takes for the compressor to start.

### LEVEL

Adjust the volume of the compressor.

### ON/OFF

This turns this effect on and off.

## 12-Using the built-in effects

### FX tab

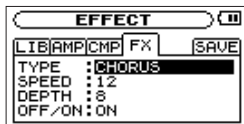

Make effect settings on this screen. Use the “TYPE” item to select the kind of effect. The items below vary according to the effect “TYPE” setting.

Use the ▲/**BROWSE** and ▼/↙ buttons to select an item, and use the **VALUE** (+/-) buttons to change the setting.

#### TYPE

Select the kind of effect from one of the following options: CHORUS, FLANGER, PHASE, TREMOLO, AUTO WAH, DELAY.

For details, see the “Effect Module Parameters List” on page 87.

### SAVE tab

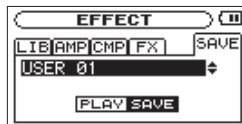

Save a set of effect settings as a user preset on this tab to allow easy access to them in the future.

Use the **VALUE** (+/-) buttons to select the user preset number (USER 01–USER 10).

Press the ► button to save the current settings to the selected user preset number.

# 13-Using the tuner

This unit has a built-in tuner. By inputting the sound of an instrument, you can use the tuning meter on the display to tune that instrument accurately. In addition, you can output a tone for tuning from the  $\Omega$ /LINE OUT jack, which is convenient for tuning multiple instruments simultaneously, for example.

## Preparation

1. Press the **TUNER** button to open the **TUNER** screen.

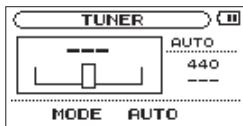

2. The "MODE" item is shown. Use the  $\updownarrow$  /  $\square$  button and  $\blacktriangleright$  button to select the tuner mode. The options are **AUTO** ( $\updownarrow$  /  $\square$ ): chromatic tuner mode) and **OSC.** ( $\blacktriangleright$ : oscillator mode).

After selecting the mode, press the **TUNER** button again to make settings for that mode.

3. The first item shown for each mode is "CALIB". Use this to set the frequency of A between 435 Hz and 445 Hz.

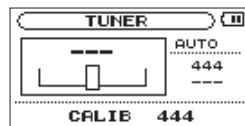

The setting value is shown on the right side of the screen. This setting is the same for both tuner modes. Use of each tuner mode is explained below.

## 13-Using the tuner

### Chromatic tuner mode (AUTO)

This is the default mode. Watch the tuning meter on the unit's screen as you tune your instrument. "AUTO" appears in the upper right. The tuning meter and input signal pitch name appear on the screen. ("---" appears when there is no input).

1. **Input the signal of the instrument that you want to tune. The name of the closest pitch appears in the upper part of the meter.**
2. **Tune the instrument until the desired pitch is shown and the center of the meter is highlighted.**

A bar appears to the left if the tuning is too low and a bar appears to the right if it is too high. The longer the bar is the more out of tune the instrument is.

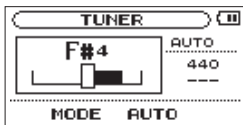

### Oscillator mode

The built-in oscillator can output a tone for tuning through the  $\Omega$ /LINE OUT jack. The tuning pitch can be set in a three-octave range (C3–B5). "OSC." appears in the upper right.

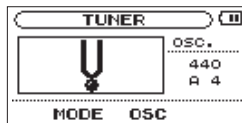

In addition to the "CALIB" item described above, the oscillator mode has the three other setting items that follow. Press the **TUNER** button to cycle through the setting items.

#### OSC NOTE

Set the pitch of the tuning tone (C3–B5).

#### OSC LEVEL

Set the output level of the tone between 0 and 10 (default value 7).

# 14-Using the Metronome

This unit has a metronome function that is convenient for practicing an instrument.

---

## Setting the metronome

---

1. Press the **METRONOME** button to open the **METRONOME** screen.

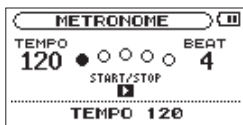

Set the following items on this screen.

Press the **METRONOME** button again to change the item.

Use the **VALUE (+/-)** buttons to change the setting value.

### TEMPO

Set the speed to a value between 20 and 250 beats per minute (BPM). The default value is 120.

### BEAT

Set the accent frequency between 0 and 9. There is no accent when set to 0. The default value is 4.

### LEVEL

Set the metronome volume between 0 and 10. The default value is 5.

---

## Starting and stopping the metronome

---

When the **METRONOME** screen is open, press the ► button to start or stop the metronome.

### NOTE

When the **METRONOME** screen is open, press the **HOME** button to stop the metronome and return to the Home Screen.

# 15-System settings

## System settings(SETUP)

On the SETUP Screen, you can change various settings according to your use environment and other requirements. You can also initialize and format the SD card.

To access the SETUP screen, press the **MENU** button to open the menu list, select the "SETUP" item using the **▲/ BROWSE** and **▼/↵** buttons and press the **▶** button or **▶▶** button.

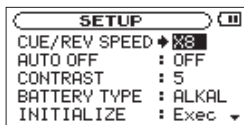

You can make the following settings on the SETUP screen. Use the **▲/ BROWSE** and **▼/↵** buttons to select the desired item. (When selected, the ":" becomes "→" and the setting value appears as light letters on a dark background.) Use the **VALUE (+/-)** buttons to change the setting value.

## Setting the forward/backward search speed

Use the CUE/REV SPEED item to set the speed of forward/backward searching when pressing and holding the **◀◀/▶▶** button during audio file playback.

Options: "x2", "x4", "x8" (Default value), "x10"

## Setting the automatic power off time

Use the "AUTO OFF" item to set the time before the unit power automatically turns OFF after the last activity or operation when powered by the internal battery.

Options: "OFF" (Default value), "3min", "5min", "10min", "30min"

## Adjusting the display contrast

Use the "CONTRAST" item to adjust the display contrast.

Range: 1-20 (Default value: 5)

## Setting the battery type

Use the "BATTERY TYPE" item to set the kind of batteries used in the unit. This setting is used to show the amount of remaining battery charge and to determine if the unit has enough power for normal operation.

Options: "ALKAL" (alkaline batteries, default value), "Ni-MH" (nickel-metal hydride batteries)



## Restoring the default values (factory settings)

Use the INITIALIZE item to restore the various settings of this unit to their factory default values.

1. Use the ▲/BROWSE and ▼/↵ buttons to select "INITIALIZE" ("Exec" appears light on dark).
2. Press the ► button to open a confirmation pop-up window.



3. Press the ► button to initialize the settings.

Press the ⏻ / I[■] button to cancel initialization.

## Using QUICK FORMAT

Use the "QUICK FORMAT" item to format an SD card quickly. Using the QUICK FORMAT item deletes all music files on the card, and automatically creates MUSIC and UTILITY folders and a dr-1.sys file.

1. Use the ▲/BROWSE and ▼/↵ buttons to Use the ▲/BROWSE and ▼/↵ buttons to Select the "QUICK

FORMAT" item ("Exec" appears light on dark).

2. Press the ► button to open a confirmation pop-up window.



3. Press the ► button to execute quick formatting.

Press the ⏻ / I[■] button to cancel quick formatting.

## Using FULL FORMAT

Use the "FULL FORMAT" item to completely format an SD card.

Using the FULL FORMAT item deletes all music files on the card, and automatically creates MUSIC and UTILITY folders and a dr-1.sys file.

If you use the FULL FORMAT item, the unit checks the memory for errors before formatting the card. For this reason it takes a long time compared to the QUICK FORMAT option.

1. Use the ▲/BROWSE and ▼/↵ buttons to select "FULL FORMAT" ("Exec" appears light on dark).
2. Press the ► button to open a confirmation pop-up

## 15-System settings

window.



### 3. Press the ► button to execute full formatting.

Press the ⏻ / I [■] button to cancel full formatting.

#### CAUTION

When formatting a card, use a TASCAM PS-P520 AC adapter (sold separately), USB bus power or confirm that the batteries are sufficiently charged. If the power fails during formatting, the formatting might not occur correctly.

## Changing the file name prefix

You can change the prefix for names given to files recorded by this unit.

1. Press the MENU button to open the MENU screen.
2. Use the ▲/BROWSE and ▼/↵ buttons to select the “FILE NAME” menu item, and press the ► button or ►► button to open the “FILE NAME” screen.

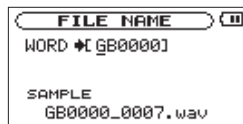

Use this to set the six characters that are used as a prefix in the names of new recordings.

Example: GB0000\_XXXX.wav

Use the ◀◀ button or ▶▶ button to move the cursor, and use the VALUE (+/-) buttons to set the characters.

After completing the setting, press the HOME button to return to the Home Screen.

#### NOTE

In addition to the alphabet and numbers, the following characters can be used: ! # \$ % & ' ( ) + , - . ; = @ [ ] ^ \_ ` { } ~  
The default name prefix is “GB0000”.

# 16-Using the footswitch

This unit has a **REMOTE** jack to which you can connect a TASCAM RC-3F footswitch-type remote control (sold separately) that can be used to operate the unit.

## Setting footswitch operation

Use the “FOOT SW” setting screen to make footswitch settings.

1. Press the **MENU** button to open the **MENU** screen.
2. Use the **▲/BROWSE** and **▼/↙** buttons to select the “FOOT SW” menu item, and press the **▶** button or **▶▶** button to open the **FOOT SW** screen.



3. The “MODE” item and the three footswitch pedal assignments are shown.

4. Use the **VALUE (+/-)** buttons to change the “MODE” item.

MODE	FOOT SW		
	L	C	R
PLAY	REW	PLAY/STOP	FWD
TRAINER	FLASH	PLAY/STOP	SPEED CHANGE
EFFECT	PRESET -	PLAY/STOP	PRESET +
RECORD	OVERDUB	REC/PAUSE	STOP
MINUTES	REW	PLAY	FWD

5. After completing the setting, press the **HOME** button to return to the Home Screen.

## Using the footswitch

Press a pedal on the footswitch to operate the unit. The function of each pedal corresponds to the assignment shown on the **FOOT SW** screen.

# 17-Viewing File Information

Use the **INFORMATION** Screen to view various types of information about the unit.

To open the **INFORMATION** screen, press the **MENU** button to open the **MENU** screen, select the "INFORMATION" item and press the **▶** button or **▶▶** button.

The **INFORMATION** screen has the following three pages.

Use the **VALUE** (+/-) buttons to switch between the pages.

- File information page (**FILE**)
  - Shows information about the currently playing file.
- Card information page (**CARD**)
  - Shows the use status of the currently inserted SD card.
- System information page (**SYSTEM**)
  - Shows information about the unit's system settings and firmware version.

When you are done, press the **HOME** button to return to the Home Screen, or press the **MENU** button to open the **MENU** screen.

## File information page

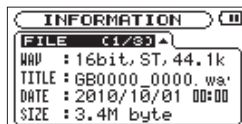

The **FILE** page shows information about the currently playing file.

### WAV or MP3

Shows the audio file format.

For WAV files, bit length, stereo/mono and sampling frequency (Hz) are shown.

For MP3 files, bit rate (kbps), CBR (constant bit rate) or VBR (variable bit rate) type and sampling frequency (Hz) are shown.

### TITLE

Shows the file name.

If an MP3 file has ID3 tag title information that information appears instead.

### DATE

Shows the date and time that the file was created.

## NOTE

This unit does not have an internal clock. For this reason, files created by this unit will always have the same fixed times for their creation and modification.

## SIZE

Shows the file size.

---

## Card information page

---

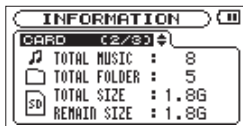

The CARD page shows the use status of the currently inserted SD card.

## TOTAL MUSIC

Shows the number of playable files in the MUSIC Folder.

## TOTAL FOLDER

Shows the number of folders in the MUSIC Folder.

## TOTAL SIZE

Shows the total SD card memory capacity.

## REMAIN SIZE

Shows the amount of unused memory on the SD card.

## USED SIZE

Shows the amount of used memory on the SD card.

## NOTE

Use the ►| button to switch between display of "REMAIN SIZE" and "USED SIZE".

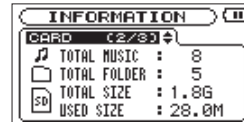

## 17-Viewing File Information

### System information page



The **SYSTEM** page shows information about the unit's system settings and firmware version.

#### **CUE/REV SPD**

Shows the speed of forward and backward searching.

#### **AUTO OFF**

Shows the automatic power OFF setting.

#### **BATTERY**

This shows the battery setting.

#### **System Ver.**

Shows the system firmware version.

# 18-Effect Module Parameters List

## Guitar and bass effects

	Module	Effect	Parameter	
AMP	AMP	Has an effect like a guitar amp.	GAIN	Adjusts gain level
			MASTER	Adjusts the output level
			TONE	Adjusts the tone.
			CAB	Sets the size of the amplifier cabinet.
			REVERB	Adjusts the volume of reverberations.
CMP	COMPRESSOR	Increases sustain by moderating the highs and lows of the input sound.	COMP	Adjusts effect depth
			ATTACK	Adjusts how fast effect starts Higher values start slower
			LEVEL	Adjusts compressor volume
			OFF/ON	Turns effect ON or OFF
FX	CHORUS	Thickens the sound by adding a slightly detuned copy to the source sound.	SPEED	Adjusts speed of chorus effect
			DEPTH	Adjusts chorus effect depth
			OFF/ON	Turns effect ON or OFF
	FLANGER	Creates a rippling effect by adding a delayed copy to the source sound	SPEED	Adjusts speed of ripple effect
			DEPTH	Adjusts depth of ripple effect
			OFF/ON	Turns effect ON or OFF
	PHASE	Creates a phasing effect that makes the sound source seem to revolve like a rotary speaker by adding a phase-shifted copy to the source sound.	SPEED	Adjusts rotation speed
			RES	Adds resonant peak to effect Higher value adds more resonance
			OFF/ON	Turns effect ON or OFF
	TREMOLO	Adds a cyclical change to the volume.	SPEED	Adjusts cycle speed
			DEPTH	Adjusts depth of volume change
			OFF/ON	Turns effect ON or OFF

## 18-Effect Module Parameters List

FX	Module	Effect	Parameter	
	AUTO WAH	This wah effect responds automatically to picking strength.	SENSE	Adjusts sensitivity to picking strength.
	MODE		Selects the tone : low pass filter (LPF), band-pass filter (BPF), high-pass filter (HPF)	
			OFF/ON	Turns effect ON or OFF
	DELAY	Thickens sound or creates an echo-like effect by adding a delayed copy to the source sound.	TIME	Adjusts delay time of effect sound
			F/B	Adjusts volume of repeating sound Higher values increase the repetitions
			LEVEL	Adjusts volume of effect sound



# 19–Messages

The following is a list of the popup messages that might appear on the GB-10 under certain conditions. Refer to this list if one of these popup messages appears and you want to check the meaning or determine a proper response.

Message	Meaning and response
File Name ERR	The DIVIDE function would cause the file name to exceed 200 characters. The DIVIDE function adds "_a" or "_b" to the end of the file name. Before choosing the DIVIDE function, connect the unit to a computer and edit the file name to less than 198 characters.
Dup File Name	The DIVIDE function would cause the file name to be the same as that of an existing file. The DIVIDE function adds "_a" or "_b" to the end of the file name. Before choosing the DIVIDE function, connect the unit to a computer and edit the file name.
File Not Found	The file added to the playlist cannot be found or a file could be damaged. Please check the file in question.
Non-Supported	The audio file is not a supported format. Please see "11-Transferring songs to and from a computer" for file formats that this unit can use.
Battery Empty	The battery is almost out of power. Replace the AA batteries.
I/O Too Short	The IN(starting) and OUT(ending) points are too close together. Reset the IN(starting) and OUT(ending) points with at least 1 second between them.
File Not Found PLAYLIST	The file in the Playlist cannot be found. Please confirm that the file is still in the Music Folder.
No PLAYLIST	No files have been added to the Playlist. Add a file to the Playlist or change the play mode to something besides PLAYLIST.
PLAYLIST Full	The playlist is full. You cannot add more than 99 tracks to the Playlist.
MBR Error Init CARD	The card is not formatted properly or the formatting is broken. Change the card or press the ► button when this message appears to format the card in FAT format. CAUTION: Execution of FAT formatting erases all data currently on the card.

## 19-Messages

Message	Meaning and response
Format Error Format CARD	The FAT formatting of the card is abnormal or broken. This message also appears if you FAT formatted the card using a computer connected by USB and if a new card is inserted in the unit. Always use the GB-10 to conduct FAT formatting of cards to be used with it. Change the card or press the ► button when this message appears to format the card in FAT format. CAUTION: Execution of FAT formatting erases all data currently on the card.
File Not Found Make Sys File	The system file is missing. This unit requires a system file for operation. When this message appears, press ► button to automatically create a system file.
Invalid SysFile Make Sys File	The system file required to operate this unit is invalid. When this message appears, press ► button to automatically create a system file.
Invalid Card Change Card	Something might be wrong with the card. Change the card.
Protected Card Change Card	This appears when the card is protected and lacks the necessary Music Folder and other folders and files. Unlock the write protect switch, restart the power and format the card.
Write Timeout	Writing to the card timed out. Backup files on the card to your computer, and format the card.
Card Full	The card has no remaining capacity. Erase unnecessary files or move them to your computer to make open space.
Layer too Deep	Folders can be created down to two layers. You cannot create a new folder inside the current folder.
Can't Divide	The position selected for divide is not suitable (too close to the beginning or end of a track).
Max File Size	The file is larger than the designated size or the recording time exceeded 24 hours.
File Full	The total number of folders and files exceeds 5000. Erase unnecessary files or move them to your computer.
Card Error	The card could not be handled properly. Replace the card.
Current File MP3	MP3 files cannot be divided.

Message	Meaning and response
File Protected	The file is read only and cannot be erased.
No Card	No card is in the unit, so recording is not possible.
No PB File	There is no file that can be played back. The file might be damaged.
No MUSIC File	There is no playback file, so DIVIDE and OVERDUB cannot be executed.
Not Continued	<p>If any of these errors occur, turn the unit power OFF and restart it. If the power cannot be turned OFF, remove the batteries and disconnect the AC adaptor (if connected). If the error message continues to appear, please contact a TEAC Repair Center.</p>
File Error	
Can't Save Data	
Player Error	
Device Error	
Writing Failed	
Sys Rom Err	
Remote Cmd	
Remote Rx	
System Err 50	
System Error 1	
System Error 2	
System Error 3	
System Error 4	

## 19–Messages

Message	Meaning and response
System Error 5	If any of these errors occur, turn the unit power OFF and restart it. If the power cannot be turned OFF, remove the batteries and disconnect the AC adaptor (if connected). If the error message continues to appear, please contact a TEAC Repair Center.
System Error 6	
System Error 7	
System Error 8	
System Error 9	

# 20–Troubleshooting

If you are having trouble with the operation of this unit, please try the following before seeking repair. If these measures do not solve the problem, please contact the store where you bought the unit or a TASCAM Service Center.

## ■ Power will not turn ON.

- Confirm that the batteries are not dead.
- Confirm that the batteries are installed with the correct +/- orientation.
- Confirm that the power plug of the AC adaptor (TASCAM PS-P520: sold separately) is securely inserted.

## ■ The foot switch does not function.

- Confirm that a battery is installed in the foot switch and that it is not dead.

## ■ The unit does not function.

- Is the unit connected to a computer by USB (USB connected) ?.

## ■ The SD card is not recognized.

- Confirm that the SD card is inserted completely.

## ■ Playback does not work.

- If you are trying to play a WAV file, confirm that the sampling frequency is supported by this unit.
- If you are trying to play an MP3 file, confirm that the bit rate is supported by this unit.

## ■ No sound is output.

- Are headphones connected?
- Check the connections with the monitoring system.
- Is the volume of the monitoring system minimized?
- Is the **OUTPUT** setting of the unit minimized?

## ■ Recording does not work.

- If you are using an external device, check the connection again.
- Confirm that the recording level is not too low.
- Has guitar input been disabled (G.IN icon  not shown light on dark)?
- Confirm that the SD card is not full.
- Confirm that the number of files has not reached the maximum that the unit can handle.

## 20-Troubleshooting

### ■ The recording level is low.

- Confirm that the input level setting is not too low.
- Confirm that the output level of a connected external device is not too low.

### ■ The playback sounds unnatural.

- Confirm that the playback pitch is not being adjusted.
- Confirm that the playback speed is not being adjusted.

### ■ I cannot erase a file.

- Is the SD card write-protect switch engaged?

### ■ This unit's files do not appear on the computer.

- Confirm that the unit is connected to the computer using its USB port.
- Are you using a USB hub?
- Confirm that the unit is not recording or in recording standby mode.

---

## Ratings

---

### Recording media

SD card (64 MB - 2 GB)

SDHC card (4 GB - 32 GB)

### Recording format

WAV: 44.1kHz, 16-bit

### playback format

WAV: 44.1 kHz, 16/24-bit

MP3: 44.1/48 kHz, 32/64/96/128/192/256/320 kbps

### Number of input channels

1 channel (mono)

---

## Input ratings

---

### Analog audio input

#### GUITAR IN jack

Connector : 1/4" (6.3 mm) mono

Input impedance : 800 k $\Omega$

Nominal input level : -13 dBV (0.2V) , (INPUT volume at 7)

Maximum input level : +3 dBV (1.4 V) , (INPUT volume at 7)

Minimum input level : -25 dBV (0.05 V) , (INPUT volume at 10)

---

## output ratings

---

### Analog output ratings

#### $\Omega$ /LINE OUT

Connector : 1/8" (3.5 mm) stereo mini

Output impedance : 23 $\Omega$

Nominal output level : -14 dBV (10 k $\Omega$  load)

Maximum output level : +2 dBV (10 k $\Omega$  load)

Maximum output : 15 mW + 15 mW (32 $\Omega$  load)

---

### Control input/output ratings

#### USB jack

Connector : Mini-B type

Format : USB 2.0 HIGH SPEED, mass storage class

#### REMOTE jack

Connector : 2.5mm TRS

## 21-Specifications

### Audio performance

#### Frequency response

20 Hz - 20 kHz +1/-5 dB  
(GUITAR IN to LINE OUT ,  $F_s=44.1$  kHz)

#### Total harmonic distortion

0.07% (GUITAR IN to LINE OUT ,  $F_s=44.1$  kHz)

#### S/N ratio

70 dB (GUITAR IN)

### Computer compatibility

#### Windows

Pentium 300 MHz or faster  
128 MB or more memory  
USB port (USB 2.0 recommended)

#### Macintosh

Power PC, iMac, G3, G4 266 MHz or faster  
64 MB or more memory  
USB port (USB 2.0 recommended)

#### Recommended USB host controller

Intel chipset

#### Supported OS

Windows : Windows XP , Windows Vista , Windows 7  
Macintosh : Mac OS X 10.2 or later



## Other specifications

### Power

Two AA batteries (Alkaline or Ni-MH)  
AC adaptor (TASCAM PS-P520, sold separately)  
USB bus power

### Power consumption

0.4 W (during MP3 playback)

### Battery operation time (continuous operation)

Alkaline type battery (EVOLTA)

About 13 hours (WAV recording time)  
About 13.5 hours (WAV playback time)  
About 13.5 hours (MP3 playback time)

Ni-MH type battery (eneloop)

About 11 hours (WAV recording time)  
About 11.5 hours (WAV playback time)  
About 11.5 hours (MP3 playback time)

### Dimensions (W x H x D)

158 x 30 x 70 mm  
6.220x1.181x2.756 in.

### Weight

160 g / 5.644 oz (not including batteries)

### Operating temperature range

0 - 40°C/32°F - 104°F

## Dimensional drawings

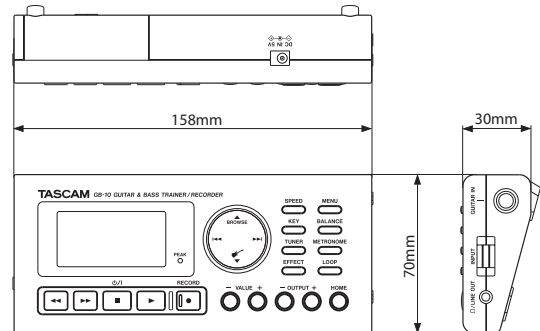

- Illustrations and other depictions may differ in part from the actual product.
- Specifications and external appearance may be changed without notification to improve the product.

## Notes



# TASCAM

# GB-10

## TEAC CORPORATION

Phone: +81-42-356-9143  
1-47 Ochiai, Tama-shi, Tokyo 206-8530 Japan

[www.tascam.jp](http://www.tascam.jp)

---

## TEAC AMERICA, INC.

Phone: +1-323-726-0303  
7733 Telegraph Road, Montebello, California 90640 USA

[www.tascam.com](http://www.tascam.com)

---

## TEAC CANADA LTD.

Phone: +1905-890-8008 Facsimile: +1905-890-9888  
5939 Wallace Street, Mississauga, Ontario L4Z 1Z8, Canada

[www.tascam.com](http://www.tascam.com)

---

## TEAC MEXICO, S.A. de C.V.

Phone: +52-55-5010-6000  
Río Churubusco 364, Colonia Del Carmen, Delegación Coyoacán, CP 04100, México DF, México

[www.teacmexico.net](http://www.teacmexico.net)

---

## TEAC UK LIMITED

Phone: +44-8451-302511  
Suites 19 & 20, Building 6, Croxley Green Business Park, Hatters Lane, Watford, Hertfordshire. WD18 8TE, U.K.

[www.tascam.co.uk](http://www.tascam.co.uk)

---

## TEAC EUROPE GmbH

Phone: +49-611-71580  
Bahnstrasse 12, 65205 Wiesbaden-Erbenheim, Germany

[www.tascam.de](http://www.tascam.de)

---

Printed in China