

Soundcraft **Vi3000**™

User Guide v1.4



**IMPORTANT**

Please read this manual carefully before using your mixer for the first time.

This equipment complies with the EMC directive 2004/108/EC and LVD 2006/95/EC

This product is approved to safety standards
IEC 60065:2001 (Seventh Edition) +A2:2010
EN60065:2002 +A1:2006 +A2:2010 +A11:2008 +A12:2011
UL60065 2012 7th Edition
CAN/CSA-E60065-03 + A2: 2012
And EMC standards
EN55103-1: 2009
EN55103-2: 2009

Warning: Any modification or changes made to this device, unless explicitly approved by Harman, will invalidate the authorisation of this device. Operation of an unauthorised device is prohibited under Section 302 of the Communications act of 1934, as amended, and Subpart 1 of Part 2 of Chapter 47 of the Code of Federal Regulations.

NOTE: This equipment has been tested and found to comply with the limits for a Class B digital device, pursuant to Part 15 of the FCC Rules. These limits are designed to provide reasonable protection against harmful interference in a residential installation. This equipment generates, uses and can radiate radio frequency energy and, if not installed and used in accordance with the instructions, may cause harmful interference to radio communications. However, there is no guarantee that interference will not occur in a particular installation. If this equipment does cause harmful interference to radio or television reception, which can be determined by turning the equipment off and on, the user is encouraged to try to correct the interference by one or more of the following measures:

- * Reorient or relocate the receiving antenna
- * Increase the separation between the equipment and the receiver
- * Connect the equipment into an outlet on a circuit different from that to which the receiver is connected.
- * Consult the dealer or an experienced radio/TV technician for help

© Harman International Industries Ltd. 2014 All rights reserved
Parts of the design of this product may be protected by worldwide patents.
Part No. 5042292
Rev 1.0
E&OE September 2014

Soundcraft is a trading division of Harman International Industries Ltd. Information in this manual is subject to change without notice and does not represent a commitment on the part of the vendor. Soundcraft shall not be liable for any loss or damage whatsoever arising from the use of information or any error contained in this manual. No part of this manual may be reproduced, stored in a retrieval system, or transmitted, in any form or by any means, electronic, electrical, mechanical, optical, chemical, including photocopying and recording, for any purpose without the express written permission of Soundcraft.

Harman International Industries Limited
Cranborne House, Cranborne Road, Potters Bar, Hertfordshire, EN6 3JN, UK
Tel: +44 (0)1707 665000
Fax: +44 (0)1707 660742
<http://www.soundcraft.com>

1.0 INTRODUCTION

- 1.1: Safety Notices & Warnings
- 1.2: Product Warranty

2.0: SPECIFICATIONS

- 2.1: Console block diagram

3.0: QUICK START GUIDE

4.0: HARDWARE OVERVIEW

- 4.1: Local I/O
- 4.2: MADI / DANTE Sources / Switching

5.0 OPERATIONS OVERVIEW

- 5.1: Manual Conventions
- 5.2: Vistonics II
- 5.3: Console Bays
- 5.4: FaderGlow™
- 5.5: Buttons
- 5.6: Encoders
- 5.7: Gangs
- 5.8: Labelling

6.0: INPUTS

- 6.1: Navigation - Fader Pages
- 6.2: The Channel Strip
- 6.3: Encoder Mode
- 6.4: VST Control
- 6.5: Touchscreen / Signal Path
 - 6.5.1: Input Section
 - 6.5.2: EQ
 - 6.5.3: Dynamics
 - 6.5.4: Busses
 - 6.5.5: Output Section

7.0: OUTPUTS

- 7.1: LCR Mix Masters
- 7.2: Bus Configuration
- 7.3: Bus Master Control
 - 7.3.1: Master Vistonics Control
 - 7.3.2: Channel Strip
 - 7.3.3: Processing Chain
- 7.3.4: Graphic EQs

8.0: MATRIX SYSTEM

9.0: MUTE & VCA GROUPS

- 9.1: Mute Groups
- 9.2: VCA Groups
- 9.3: Aux VCA Groups

10.0: MONITORING

- 10.1: Console Controls
- 10.2: Setup
 - 10.2.1: MON Setup

11.0: SOLO SYSTEM

- 11.1: Primary Behaviour
- 11.2: Input Priority Mode
- 11.3: Autocancel Behaviour
- 11.4: Follow Output Solo Mode

12.0: METERING

- 12.1: Inputs
- 12.2: Busses

13.0: EDIT SYSTEM (COPY, PASTE, AND LIBRARY)

- 13.1: Copy, Paste, Undo
- 13.2: Library Basics
- 13.3: Library File Screen

14.0: SNAPSHOTS, CUELISTS, GLOBAL FILTER

- 14.1: Console Controls
- 14.2: Cuelist Control
- 14.3: Cue Details
 - 14.3.1: Cue Number & Timecode
 - 14.3.2: Snapshot/Cue Name
 - 14.3.3: MIDI
 - 14.3.4: GPIO
- 14.4: Snapshot Filters
 - 14.4.1: Snapshot Filter Scope
 - 14.4.2: Global Filter

15.0: TALKBACK & OSCILLATOR

- 15.1: Console Controls
- 15.2: Oscillator Setup & Use
- 15.3: Talkback Setup
- 15.4: Talkback Return Setup

16.0: MAIN MENU

- 16.1: Main (Screen, Security)
- 16.2: Shows
 - 16.2.1: Show File Data
- 16.3: GPIO
- 16.4: Sync
- 16.5: Tielines
- 16.6: FX
- 16.7: MIDI
- 16.8: Log
- 16.9: Settings
- 16.10: System

17.0: LEXICON FX

- 17.1: Using The FX Processors
 - 17.1.1: Tap Tempo Functionality
- 17.2: FX Algorithms & Parameters
 - 17.2.1: Reverbs
 - 17.2.1: Delays
 - 17.2.1: Misc

18.0: VM² Wireless Status Monitoring / HiQnet

- 18.1: HiQnet Network Configuration
 - 18.1.1: VM² Device List
- 18.2: Status Displays
 - 18.2.1: Channel Strip Status
 - 18.2.2: VST Status



Welcome To The Vi3000!

New Look

The Soundcraft Vi3000 features an all-new appearance with a more efficiently designed control surface, 36 faders, 24 mono/stereo busses and a sweeping black screen panel with four Vistonics II™ touchscreen interfaces with sleek, updated 3D graphics. Because the Vi3000 has four touchscreens, it's the only console in its class that can be used by two engineers at the same time. And at show time... Settings libraries, copy/paste functions, sophisticated automation and radio mic status monitoring, FaderGlow™, processing from dbx, BSS, Lexicon and Universal Audio (Optional Realtime Rack), and more will not let you down.

SpiderCore DSP

The Vi3000 is a console with friends in high places. Sound quality is assured by Soundcraft SpiderCore - a brand new 40-bit floating point DSP engine that mixes FPGA and DSP technology in a unique combination that maximises I/O routing and DSP mixing capability in a footprint small enough for inclusion within a control surface.

FX

Internal FX come courtesy of 4 independent stereo Lexicon multi effects units, each providing a choice of 14 reverbs, 7 delays and 8 pitch shifting effects, patchable to input channels, aux outputs and channel inserts. BSS third-octave Graphic EQ is available on every bus output, with fader bays illuminating in red to indicate GEQ mode.

...And More FX

The Vi3000 can also accommodate the new Soundcraft Realtime Rack, a hardware/software unit designed in collaboration with plug-in manufacturer Universal Audio that provides access to 74 industry-standard UAD plug-ins.

DANTE As Standard

The Vi3000 is the first Soundcraft console to incorporate a Dante interface as standard, for seamless digital audio networking with Dante-enabled devices.

Connectivity

In addition to a full complement of analog and digital inputs and outputs, the console provides MIDI, USB, Ethernet, DVI out, Dante/MADI record feed outputs, redundant power supply and other connections. The Vi3000 has two expansion bays that can be fitted with MADI Stagebox cards, to connect multiple Soundcraft Stagebox input expander modules.

Shine A Light

Along with its greatly expanded functionality, the Vi3000 retains all the features that have made the Soundcraft Vi Series the consoles of choice for live sound engineers worldwide, such as FaderGlow™ - illuminated faders that display different colors according to function, the ability to store and recall snapshots and cues, compatibility with Soundcraft's ViSi app that allows remote control from an iPad.

Optional 64 channel stagebox

With up to 48 on-board mic inputs, Vi3000 is happy to work with existing analogue multicore systems. Also available is an optional remote stagebox housing 64 analogue mic/line inputs and 32 analogue line outputs, with 48V phantom power and a 80Hz HPF before the A-D converters. Mic amp gain can be controlled remotely from the console surface.

SAFTEY NOTICES

For your own safety and to avoid invalidation of the warranty please read this section carefully.

THIS UNIT MUST BE EARTHED

Under no circumstances should the mains earth be disconnected from the mains lead.



The wires in the mains lead are coloured in accordance with the following code:

Earth: Green and Yellow (Green/Yellow - US)

Neutral: Blue (White - US)

Live: Brown (Black - US)

As the colours of the wires in the mains lead may not correspond with the coloured markings identifying the terminals in your plug, proceed as follows:

The wire which is coloured Green and Yellow must be connected to the terminal in the plug which is marked with the letter E or by the earth symbol.

The wire which is coloured Blue must be connected to the terminal in the plug which is marked with the letter N.

The wire which is coloured Brown must be connected to the terminal in the plug which is marked with the letter L.

Ensure that these colour codings are followed carefully in the event of the plug being changed.



The internal power supply unit contains no user serviceable parts. Refer all servicing to a qualified service engineer, through the appropriate Soundcraft dealer.



WARNINGS

- **Read** these instructions.
- **Keep** these instructions.
- **Heed** all warnings.
- **Follow** all instructions.
- **Clean** the apparatus only with a dry cloth.
- **Do not** install near any heat sources such as radiators, heat resistors, stoves, or other apparatus (including amplifiers) that produce heat.
- **Do not** block any ventilation openings. Install in accordance with the manufacturer's instructions.
- **Do not** use this apparatus near water.
- **Do not** defeat the safety purpose of the polarized or grounding type plug. A polarized plug has two blades with one wider than the other. A grounding type plug has two blades and a third grounding prong. The wide blade or the third prong are provided for your safety. When the provided plug does not fit into your outlet, consult an electrician for replacement of the obsolete outlet.
- **Protect** the power cord from being walked on or pinched particularly at plugs, convenience receptacles and the point where they exit from the apparatus.
- **Only** use attachments/accessories specified by the manufacturer.
- **Unplug** this apparatus during lightning storms or when unused for long periods of time.
- **Refer** all servicing to qualified service personnel. Servicing is required when the apparatus has been damaged in any way such as power-supply cord or plug is damaged, liquid has been spilled or objects have fallen into the apparatus, the apparatus has been exposed to rain or moisture, does not operate normally or has been dropped.
- **Use** only with the cart, stand, tripod, bracket or table specified by the manufacturer, or sold with the apparatus. When the cart is used, use caution when moving the cart/apparatus combination to avoid injury from tip-over.
- **No** naked flame sources, such as lighted candles or cigarettes etc., should be placed on the apparatus.
- **Warning:** To reduce the risk of fire or electric shock, do not expose this apparatus to rain or moisture. Do not expose the apparatus to dripping or splashing and do not place objects filled with liquids, such as vases, on the apparatus.
- **No user serviceable parts.** Refer all servicing to a qualified service engineer, through the appropriate Soundcraft dealer.
- **Ventilation** should not be impeded by covering the ventilation openings with items such as newspapers, table cloths, curtains etc.
- **It is recommended** that all maintenance and service on the product should be carried out by Soundcraft or its authorised agents. Soundcraft cannot accept any liability whatsoever for any loss or damage caused by service, maintenance or repair by unauthorised personnel.



WARRANTY

1 Soundcraft is a trading division of Harman International Industries Ltd.

End User means the person who first puts the equipment into regular operation.

Dealer means the person other than Soundcraft (if any) from whom the End User purchased the Equipment, provided such a person is authorised for this purpose by Soundcraft or its accredited Distributor.

Equipment means the equipment supplied with this manual.

2 If within the period of twelve months from the date of delivery of the Equipment to the End User it shall prove defective by reason only of faulty materials and/or workmanship to such an extent that the effectiveness and/or usability thereof is materially affected the Equipment or the defective component should be returned to the Dealer or to Soundcraft and subject to the following conditions the Dealer or Soundcraft will repair or replace the defective components. Any components replaced will become the property of Soundcraft.

3 Any Equipment or component returned will be at the risk of the End User whilst in transit (both to and from the Dealer or Soundcraft) and postage must be prepaid.

4 This warranty shall only be available if:

- a) The Equipment has been properly installed in accordance with instructions contained in Soundcraft's manual.
- b) The End User has notified Soundcraft or the Dealer within 14 days of the defect appearing; and
- c) No persons other than authorised representatives of Soundcraft or the Dealer have effected any replacement of parts maintenance adjustments or repairs to the Equipment; and
- d) The End User has used the Equipment only for such purposes as Soundcraft recommends, with only such operating supplies as meet Soundcraft's specifications and otherwise in all respects in accordance Soundcraft's recommendations.

5 Defects arising as a result of the following are not covered by this Warranty: faulty or negligent handling, chemical or electro-chemical or electrical influences, accidental damage, Acts of God, neglect, deficiency in electrical power, airconditioning or humidity control.

6. The benefit of this Warranty may not be assigned by the End User.

7. End Users who are consumers should note their rights under this Warranty are in addition to and do not affect any other rights to which they may be entitled against the seller of the Equipment.



Vi3000 Specifications

Frequency Response

Stagebox or Local Mic input to Line output **+0/-1dB, 20Hz-20kHz**

AES/EBU In to AES/EBU Out **+0/-0.2dB, 20Hz-20kHz**

T.H.D. & Noise

(22Hz-22kHz, unweighted)

Stagebox or Local Mic In (min gain) to Local Line Out **<0.004% @ 1kHz**

Stagebox Mic In (max gain) to Local Line Out **<0.035% @ 1kHz**

Mic Input E.I.N. **<-127dBu (150Ω source)**

(22Hz-22kHz bandwidth, unweighted)

Residual Noise **-95dBu**

(Stagebox line output; no inputs routed, Mix fader @0dB)

CMRR **80dB @ 1kHz**

(Stagebox Mic input)

Sampling Frequency **48kHz**

Latency **< 2ms @48kHz**

(Stagebox Mic Input to Local Line output)

AES/EBU Input Sample Rate **32–108kHz (with SRC enabled)**

DSP Resolution **40-bit floating point**

Internal Clock

Accuracy **< +/- 50ppm**

Jitter **< +/- 2ns**



External Sync BNC Wordclock, Dante network clock

Input & Output Levels

Mic/line Inputs	+28dBu max
Line Outputs	+22dBu max
Nominal Operating Level	+4dBu (-18dBFS)

Input & Output Impedances

Mic Inputs	2k7Ω
All other analogue Inputs	>10kΩ
Line Outputs	<75Ω
AES/EBU Outputs	110Ω

Oscillator 20Hz to 20kHz/Pink/White Noise, variable level

Channel Filters

Mic In HP Filter	80Hz fixed, 12dB per octave
Channel HP Filter	20Hz-600Hz, 18dB per octave
Channel LP Filter	1kHz-20kHz, 18dB per octave

EQ (Inputs and Bus Outputs)

HF	20Hz-20kHz, +/-18dB, Q= 0.3-8.7 or shelving
Hi-Mid	20Hz-20kHz, +/-18dB, Q=0.3-8.7
Lo-Mid	20Hz-20kHz, +/-18dB, Q=0.3-8.7
LF	20Hz-20kHz, +/-18dB, Q= 0.3-8.7 or shelving

Metering Internal 20-segment LED bargraphs plus 9-segment gain reduction meters for all inputs and Outputs Peak hold variable from 0-2s.

Mains Voltage Operating Range 90-264V, 47-63Hz, auto-ranging



Mains Power Consumption

Console **300W (both PSUs operating)**

Stagebox (64in/32out) **150W (both PSUs operating)**

Internal Mass Storage 120GB SSD Hard Drive

Temperature/Humidity Range

Operating Temperature Range **0°C – 45°C (32°F – 113°F)**

Relative Humidity **0% – 90%, non-condensing Ta=40°C (104°F)**

Storage Temperature Range **-20°C – 60°C (-4°F – 140°F)**

Weight 54kg

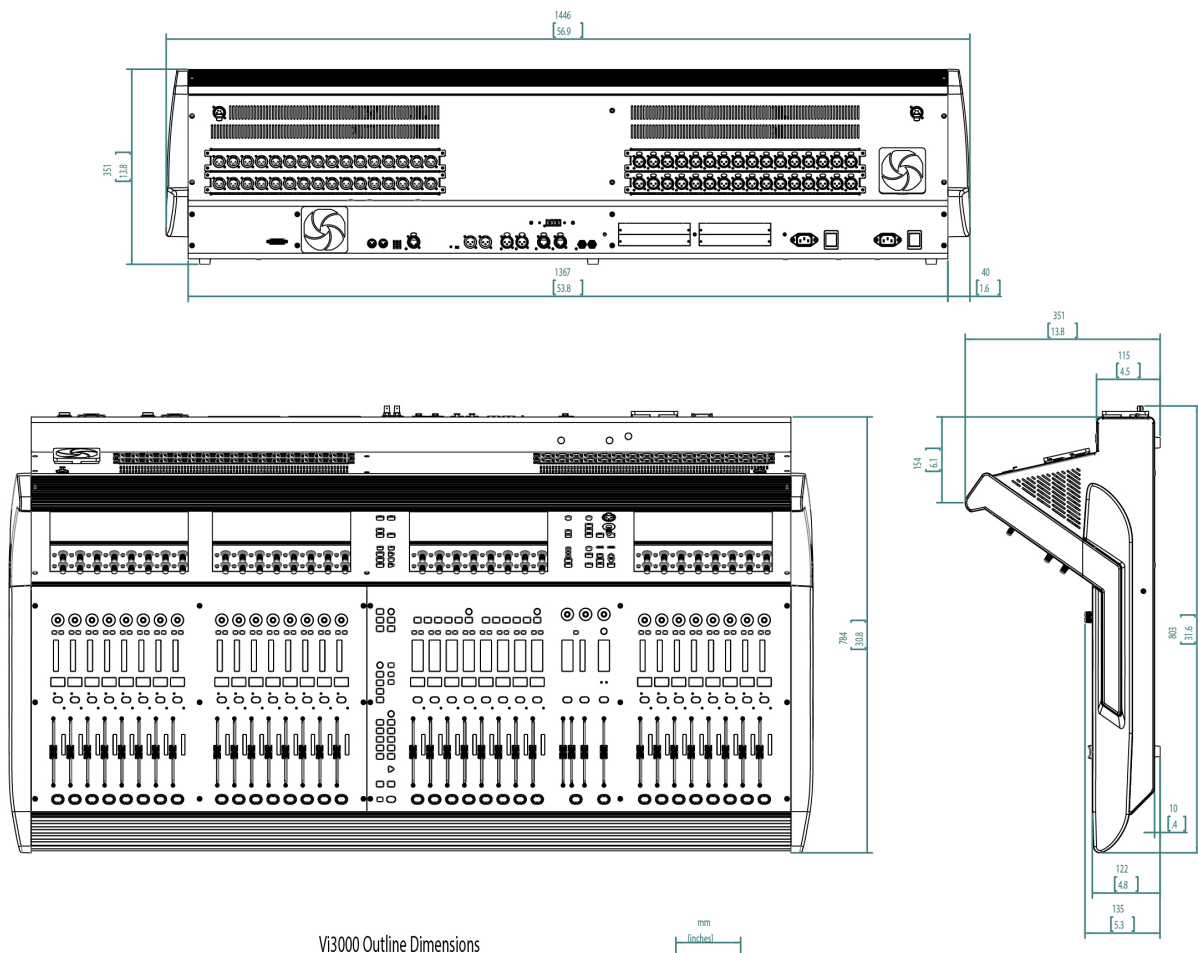

Soundcraft reserves the right to improve or otherwise alter any information supplied in this document or any other documentation supplied hereafter. E&OE 05/2014

INPUTS

PATCH

INPUT CHANNELS / MATRIX

MASTER / MIX / MONITORING

OUTPUTS

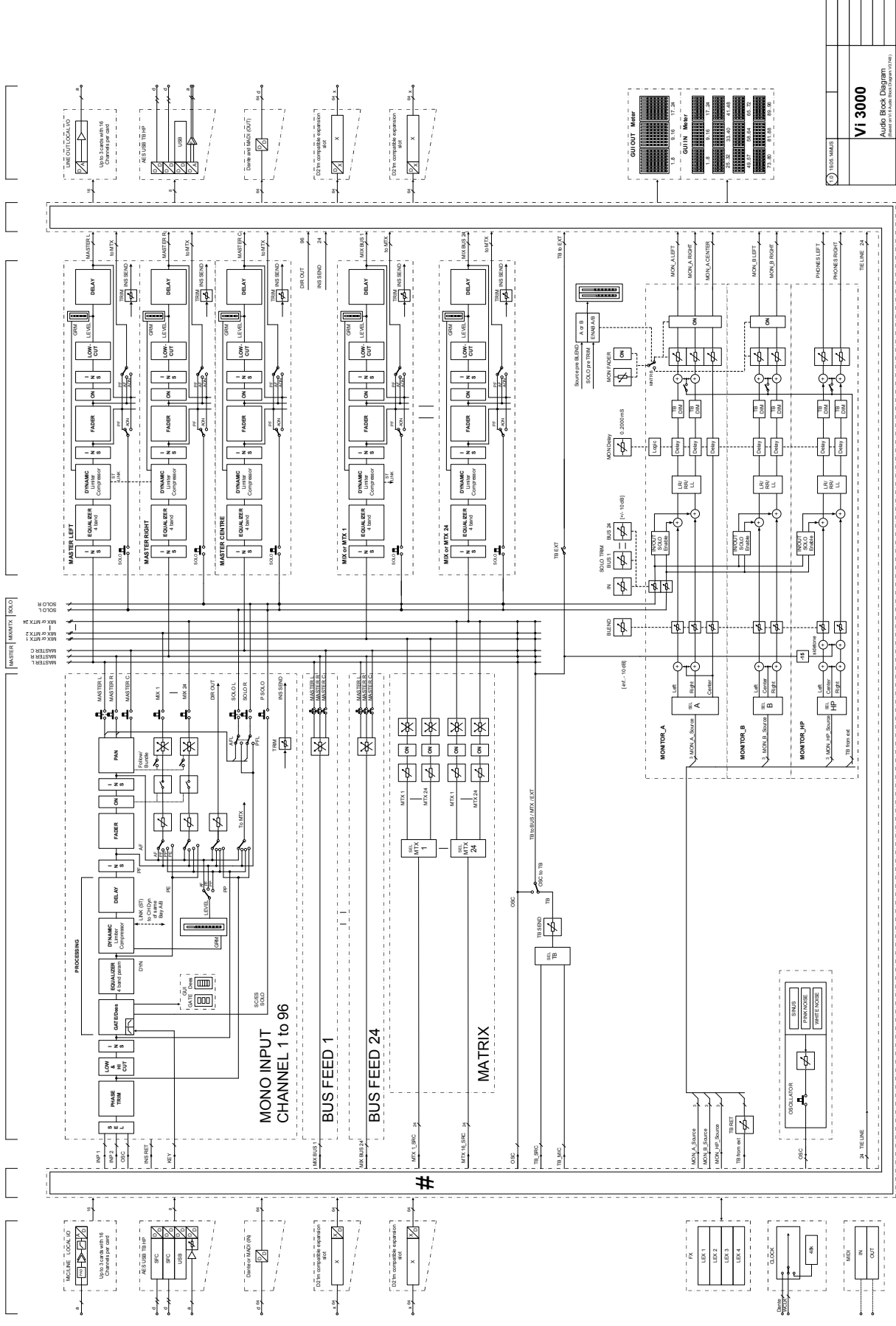

© 2005 HARMAN
Vi 3000
Audio Block Diagram
(Revised 04/10/05, Max 100 pages (10/05))

Quick Start Guide

This chapter is a pictorial guide through the main concepts and functionality of the Vi3000 console. Subsequent chapters go into these functions in more detail.

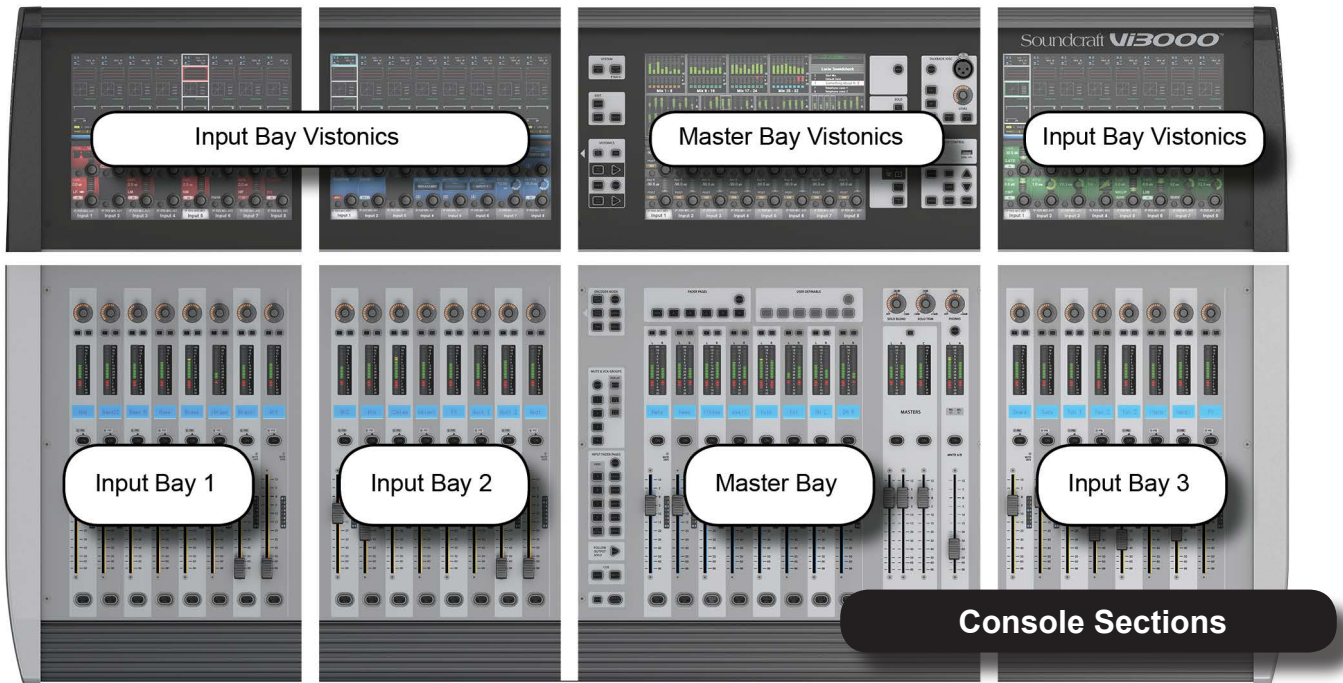

Channel Group / processing blocks

Vistronics II Input Bay Screen Areas And Fields



Buttons And Encoders

VST Encoders (Encoders 1 and 2).



The Input Bay VISTONICS buttons allow convenient, rapid access to output contributions on the Input Bay Vistronics encoders.



The Master Bay VISTONICS button group [PAGE A] and [PAGE B] buttons determine which bus master range is controlled by the encoders Master Bay VST encoders.



Channel Encoders (Encoder 3).



The Input Channel ENCODER MODE button group sets the Input Channel encoder function.

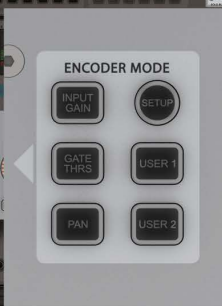

Ganging



Ganging allows temporary grouping of channels and parameters to make adjustment and configuration of multiple channels quicker and easier. To Gang channels, hit the [GANG] button then add or subtract channels with their [SOLO/SEL] buttons.



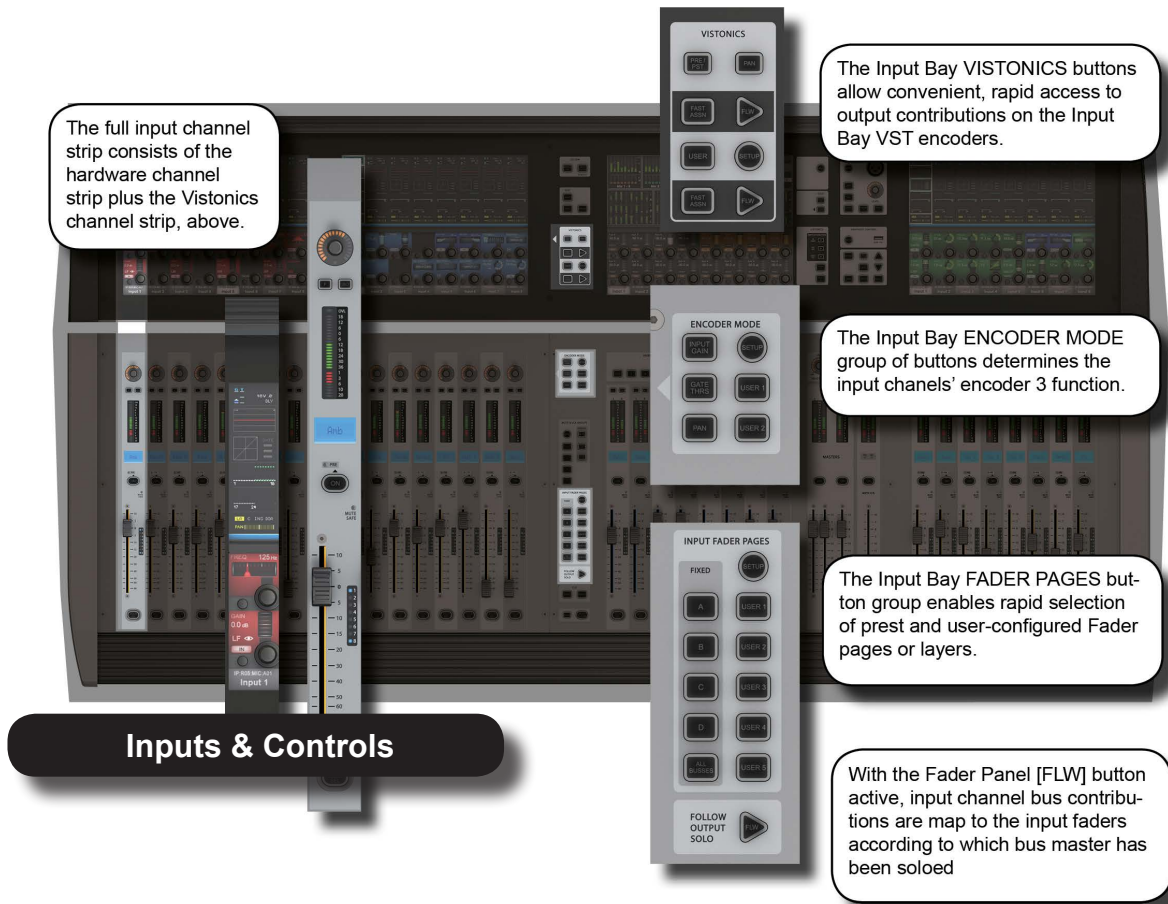

The full input channel strip consists of the hardware channel strip plus the Vistonics channel strip, above.

The Input Bay VISTONICS buttons allow convenient, rapid access to output contributions on the Input Bay VST encoders.

The Input Bay ENCODER MODE group of buttons determines the input channels' encoder 3 function.

The Input Bay FADER PAGES button group enables rapid selection of prest and user-configured Fader pages or layers.

With the Fader Panel [FLW] button active, input channel bus contributions are map to the input faders according to which bus master has been soloed

Inputs & Controls

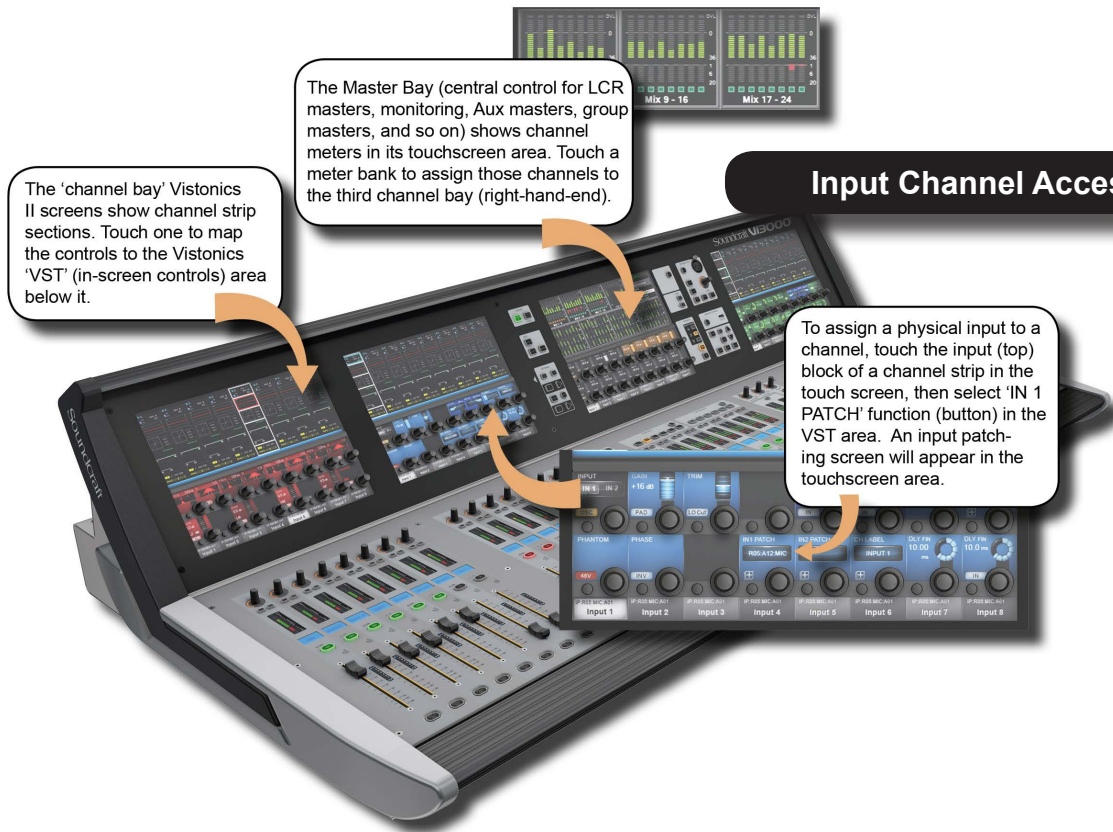

The Master Bay (central control for LCR masters, monitoring, Aux masters, group masters, and so on) shows channel meters in its touchscreen area. Touch a meter bank to assign those channels to the third channel bay (right-hand-end).

The 'channel bay' Vistonics II screens show channel strip sections. Touch one to map the controls to the Vistonics 'VST' (in-screen controls) area below it.

Input Channel Access

To assign a physical input to a channel, touch the input (top) block of a channel strip in the touch screen, then select 'IN 1 PATCH' function (button) in the VST area. An input patching screen will appear in the touchscreen area.

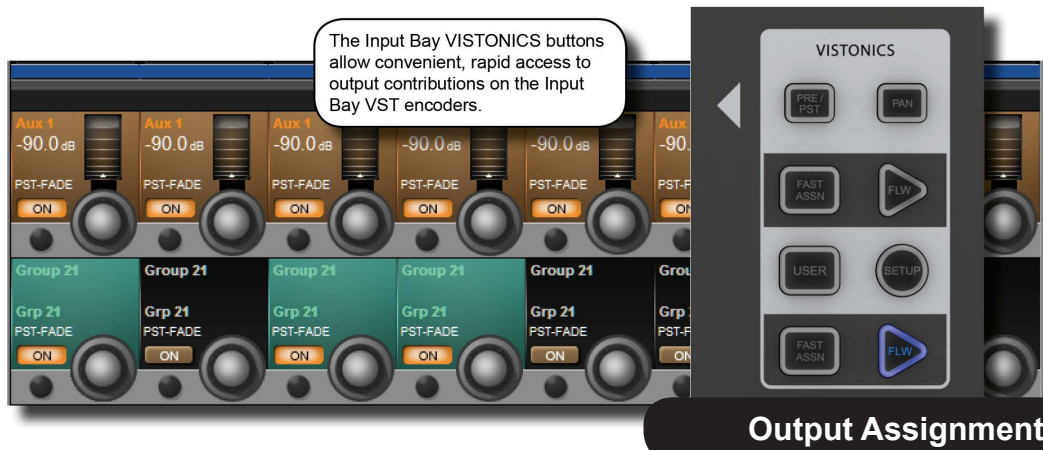
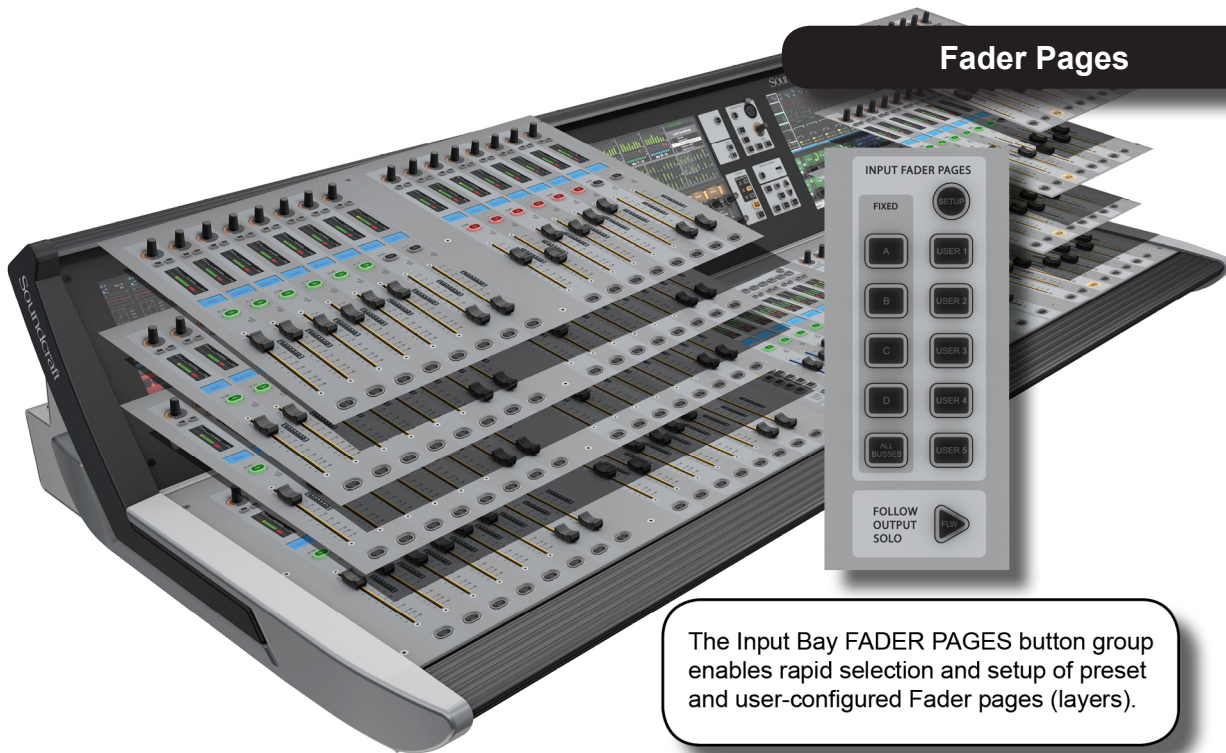

Outputs & Control

Touch a section of bus meters in the master bay touch screen to assign those outputs to the right-hand Input Bay controls.

The Input Bay VISTONICS buttons allow convenient, rapid access to output contributions on the Input Bay Vistonics encoders.

The [All-BUSSES] button assigns all bus masters to the 24 input channels for convenient control and setup.

Hit [FLW] and then a bus master [SOLO/SEL] button to map the contributions to that bus to the input faders.

Use the [Page A] and [Page B] buttons to switch the Master Bay VST encoders between banks of bus masters.

The SWITCH FUNCTION buttons change the function of the VST buttons.

The master FADER PAGES assign pages of eight VCA and bus masters to the Master Bay channel strips.



There are three main monitoring outputs - A, B, and headphones. You can select a variety of sources for the monitoring outputs, including two user-definable sources (USER A, USER B) with separate left and right assignments.



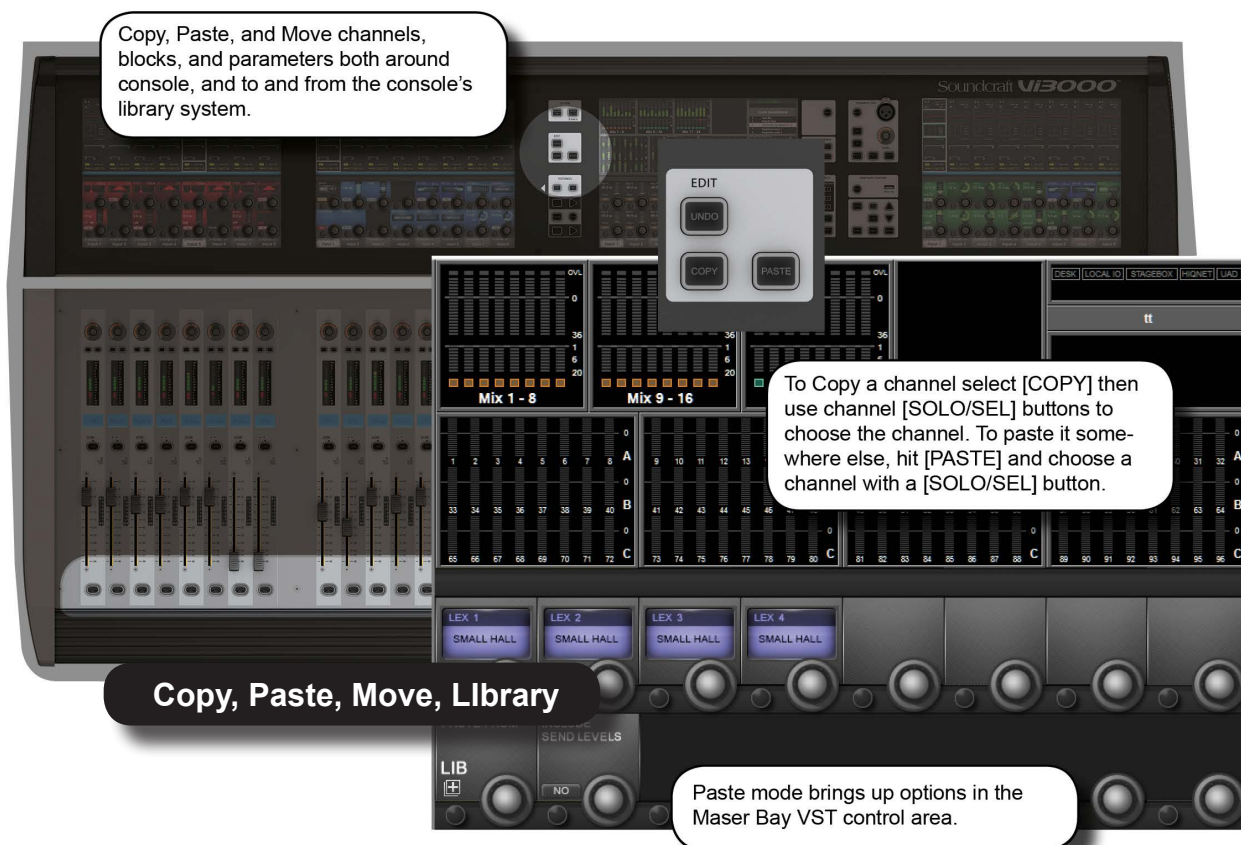

Console [ISO] buttons isolate the channels from snapshot recall and (when Global Filtering is active) from Show recall..

The SNAPSHOT CONTROL button group: The [SETUP] buttons brings the detailed cuelist controls to the Master Bay Vistonics area.

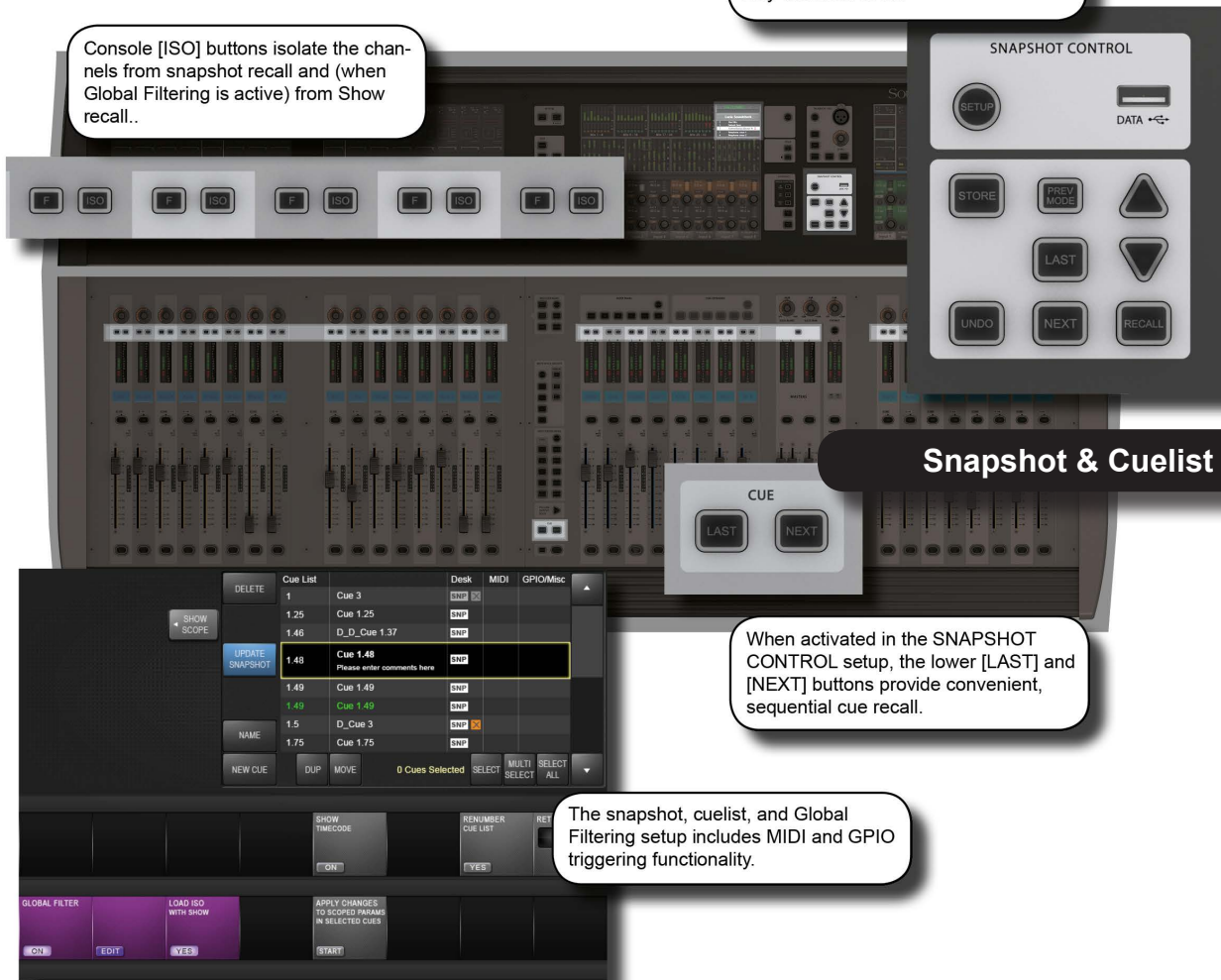

Snapshot & Cuelist

When activated in the SNAPSHOT CONTROL setup, the lower [LAST] and [NEXT] buttons provide convenient, sequential cue recall.

The snapshot, cuelist, and Global Filtering setup includes MIDI and GPIO triggering functionality.



Main Menu System



The [MENU] button puts the console's main menu on the Master Bay touch screen for access to Shows, GPIO, digital audio sync, tieline patching, Lexicon FX control, MIDI setup, the message log, general settings, and system information

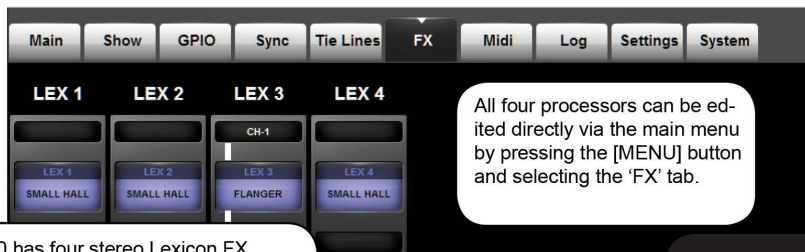

All four processors can be edited directly via the main menu by pressing the [MENU] button and selecting the 'FX' tab.

The Vi 3000 has four stereo Lexicon FX processors onboard that can be patched to auxilliary outputs or as inserts in both input and output channels.

Lexicon FX



There are 29 available algorithms under the Reverb, Delay, and Misc categories. FX settings are integrated with the snapshot and library systems.

Assign FX via the appropriate channel strip block.

You can also edit FX by touching a channel strip where an FX processor has been assigned.



Hardware - Local I/O



Most of the Vi3000 local I/O is located on the rear panel of the console. The main I/O slots have a variety of possible configurations, including digital (AES) and analogue input and output cards. However, the monitor / masters output section cannot be changed - this contains the fixed-routing Monitor A and Monitor B outputs, plus the master LCR analogue outputs.

There are also user-configurable D21m I/O expansion slots that can accept any of the available Soundcraft D21m compatible I/O cards. Options for these include MADI (Optical or CAT 5), ADAT, Blu Link, Aviom, Ethersound, Co-branet, Line in, line out, AES/EBU, and mic in. The D21m IO Expansion slots are also used for connecting a Soundcraft Stagebox.

Fixed I/O on the rear panel includes all data/digital connections such as MIDI, USB, HiQnet, AES I/O, DANTE, MADI, Word Clock, and DVI Out, plus the dual redundant power supply connections.

There are also two 12v lamp connections.

The control surface of the console features two additional USB sockets and a talkback microphone XLR connection.

Main I/O Slots

	<p>The main local I/O slots.</p>	<p>The monitor / masters output section cannot be changed (bottom left of the main picture) as this contains the fixed-routing Monitor A and Monitor B outputs, plus the master LCR analogue outputs. Configuration options for the other slots are: 32 mic in/32 line outs, 48 mic in / 16 line out (the upper line out card is replaced by a mic in 33-48 card), 16 mic in / 16 in 16 out AES / 16 line out (the mic in 1-16 card is replaced by a blank, the upper line out module 1-16 is replaced by a 16 in 16 out AES module).</p>		
---	----------------------------------	---	--	--

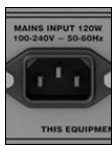

PSU / Power Sockets

	<p>There are two mains inputs for seamless redundancy for those that require it. The IEC inlets can accept AC inputs from 100V to 240V.</p>	<p>Either socket can be used for a single supply, if both are used then one is a backup. The two sockets are labelled PSU1 and PSU2, corresponding to indicator lights on the Menu-System-Local page. The colour of this indicator, and the power button on front panel of the console, indicates the state of these PSUs: RED if only one of them is on, and GREEN if both are on.</p>		
---	---	---	--	--

Power Switches

		Inactive	Active
	<p>There is a power switch for each of the power supply inputs. Both need to be on for the dual redundancy switching to be effective.</p>	<p>Power off</p>	<p>Power on</p>

DVI (Digital Video) output

	<p>For future use.</p>			
--	------------------------	--	--	--

MIDI In / Out

	<p>5-Pin DIN connectors for MIDI compatible equipment only.</p>			
---	---	--	--	--

USB

	<p>The console USB connections can be used for connecting an external keyboard or for USB storage devices.</p>			
---	--	--	--	--

HiQnet Interface

	<p>XLR-housed EtherCon connector for HiQnet network connection.</p>	<p>For details on HiQnet setup, please refer to reference chapter 18.</p>		
---	---	---	--	--



AES I/O

	<p>2 x 3-pin XLR AES (two-channel) digital audio input and output.</p>	<p>4 channels of AES/EBU format outputs and 4 channels of inputs. AES 1-2 and 3-4 Input sockets have associated green confidence LEDs that indicate a valid sync signal is present.</p>		
---	--	---	--	--

DANTE

	<p>Input and output Interface ports for a DANTE (Audinate) digital audio network.</p>	<p>Please note, the Vi 3000 MADI local MADI and DANTE ports share an input and so are exclusive. That is, you can choose either a local MADI or DANTE input. The outputs are 'parallel' and a work concurrently. The choice between the MADI and DANTE inputs is determined by the DANTE/MADI global switch in the Setting tab of the main menu - accessed with the [MENU] button.</p>		
---	---	--	--	--

MADI I/O

	<p>Input and output Interface ports for connection to/from MADI-compatible equipment.</p>	<p>Please note, the Vi 3000 MADI local MADI and DANTE ports share an input and so are exclusive. That is, you can choose either a local MADI or DANTE input. The outputs are 'parallel' and a work concurrently. The choice between the MADI and DANTE inputs is determined by the DANTE/MADI global switch in the Setting tab of the main menu - accessed with the [MENU] button. Connections are via multimode SC connectors.</p>		
--	---	---	--	--

Wordclock I/O

	<p>Outputs console wordclock or syncs to external wordclock at 48kHz.</p>			
---	---	--	--	--

Talkback Mic 48V

	<p>Switch to apply 48V phantom power to the talkback mix input on the top panel of the console.</p>		<p>Inactive</p> <p>No Power</p>	<p>Active</p> <p>phantom powered</p>
---	---	--	--	---

D21m Slots

	<p>D21m Slots, labelled slots I, J, K, and L.</p>	<p>These card slots can be used for any available D21m option cards of which there is a large range including MADI (Cat 5 or Optical) Stagebox connection, ADAT (16ch single slot), Blu Link (32ch single slot), Aviom (16 ch single slot), Ethersound (64ch double slot), Cobranet (32ch single slot), Line in (8ch single slot), line out (8ch single slot), AES/EBU (16ch double slot), and mic in (4ch single slot).</p>		
---	---	--	--	--



DANTE / MADI Interface and switching notes

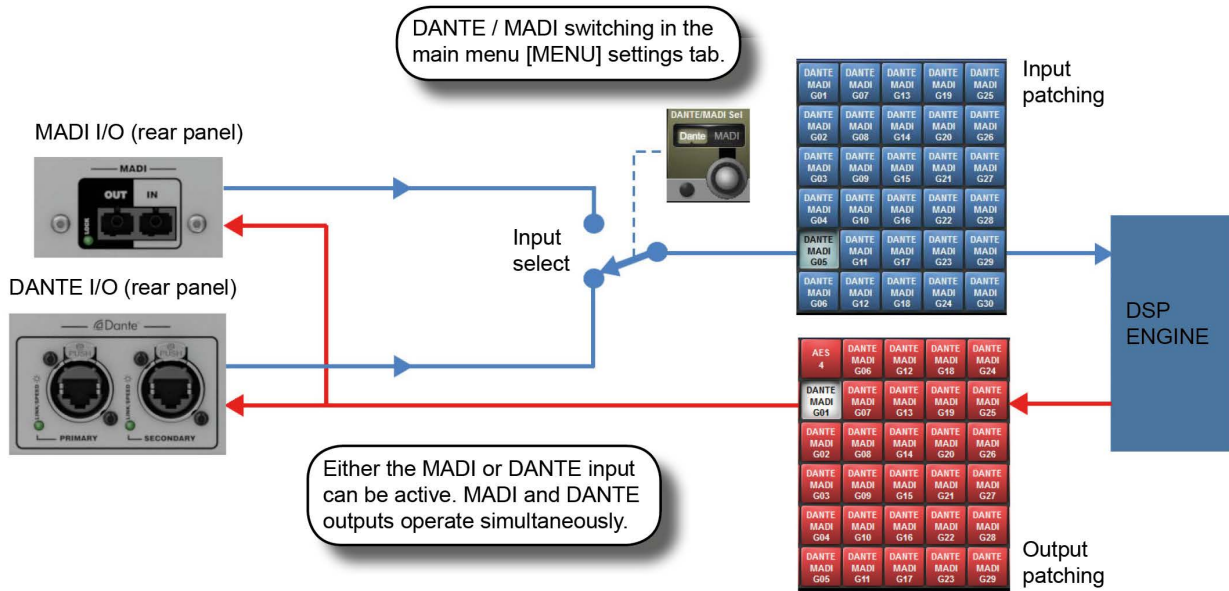

The Dante/MADI interface gives the Vi3000 a lot of flexibility for recording shows, Virtual Soundchecking or interfacing with third party MADI or Dante-enabled equipment such as signal routers or system processors. The interface comprises an input (64ch) in each format and an output (64ch) in each format. The outputs are fed by a common signal source which is available to any channel or bus via the Dante/MADI buttons within the Local tab of the console's output patching matrix. The patched signal is fed to both Dante and MADI outputs simultaneously. The inputs are selectable using a global switch in the Menu-Settings page of the console to choose either the Dante or the MADI port as the active input. Whichever of these is selected will appear in the Local tab of the input patch matrix in the console and will be labelled Dante or MADI as appropriate. Only one input can be used at a time.

Recording

64ch recording/replay is possible via the MADI interface using a third-party MADI interface such as RME MADIface, in most cases the recording software can be set to take its clock source from the console's MADI stream. Alternatively the console's Wordclock Out can be used to drive the recording software or router, or the console can be slaved to the other equipment's clock via Wordclock In.

Alternatively, 64ch recording/replay can be achieved via the Dante port, by simply installing a copy of the Dante Virtual Soundcard driver (DVS), available from the Audinate website. A free one-off license token is included with every Vi3000 console -see the documentation packaged with the console. The license token number is used on the Audinate website to enable the issuing of a license key code which is then entered into the DVS boot screen to unlock the software. Dante Virtual Soundcard is available in PC and Mac formats and allows the the standard ethernet port on the computer to become visible as a 64ch input/output low-latency audio interface from any audio recording or processing software.

Interfacing to another Dante-enabled device or network

The Dante interface allows connection to any other Dante-enabled device, either directly or via a network switch, and using either normal or redundant connections depending on how the primary and secondary Dante ports of each device have been configured. Although the patching of signals to/from channels or busses in the console is done via the console's patch matrix, the routing of those 64 in and out signals within the Dante network has to be set up using a free software application called Dante Controller, available from the Audinate website and running on either a PC or Mac external computer. Using this software it's possible to make connections on an individual channel basis between the Vi3000's 64ch Dante interface and all other Dante equipment on the network.



Syncing with Dante equipment

Detailed setup of Dante network is beyond the scope of this User Guide (see user-guide documentation for Dante Controller software for more details), but it is important to understand the concept of synchronisation within a Dante network, even if there are only two devices in the network. In any audio network there must be one device acting as clock master, the others are then slaves. In the Dante network, this device is known as the Primary Master. There can also be secondary masters - these are devices that are normally slaves but will take over the role of Master clock should the designated Master fail or be disconnected from the network. The status Primary/Secondary Master/Slave must be set for each device, including for the Vi3000, using external Dante Controller software - it cannot be done from within the console's software. (Note: The Vi3000's Dante interface is set as factory default to act as Primary Master). The status of the Vi3000's clock config must be setup to work correctly with the Dante interface, depending on whether the console is acting as Master or Slave on the network:

Console acting as Primary Master	Select INT 48kHz clock in Menu-Sync page of console. Check 'Slave to ext wordclock' in Dante Controller software for Vi3000 Dante interface
Console acting as Slave on Dante network.	Select DANTE external clock in Menu-Sync page of console. Check 'Slave to ext wordclock' in Dante Controller software for Vi3000 Dante interface.

Note: The option 'Slave to External Wordclock' in Dante Controller software is confusingly named as far as Vi3000 is concerned, it actually refers to whether the Dante interface itself within the Vi3000 is locked to an 'external' clock - in this case meaning the INTERNAL w/clock of the Vi3000 itself. If the Slave to Ext Wordclock box is NOT checked, then it means the Dante I/F will sync to network clock, ie the clock of the Primary Master.

See Chapter 16: Main Menu, Sync page for further info.



5.0: Operations Overview



5.1: Conventions And Colours



This manual, and the console uses certain conventions to make things significantly easier for the user. This includes the unique FaderGlow technology that can dynamically colour code console faders depending on their current assignment.

Conventions used in this manual

Three types of brackets are used to indicate the type of control being referred to.

[] is used to indicate a panel-mounted key or encoder.

{ } is used to indicate a Vistonics™ (VST) key or encoder.

() is used to indicate a button on a touch-screen.

COLOURS

The following table shows colours used in the VISTONICS screens, and in the headers and footers of the pages in this manual:

Audio Processing

Input Functions	Blue
Equaliser	Red
Filter	Blue
Gate, Comp, Lim, De-ess	Green
Pan, Dir Out, Insert	Yellow
Oscillator	Gold
Monitoring	Lilac

Busses

Aux	Orange
Audio Group	Green
Matrix	Cyan

VCA/MG Indication

VCA 1..8	Blue
VCA 9..16	Pink
Aux VCA Master 1..16	White
Mute Group	Red

Patching & Misc

Input Patch	Blue
Output Patch	Red



5.2: Vistonics Overview



Vistonics II Input Bay Screen Areas And Fields

Vistonics II is a unique control and display technology derived from the Studer Vistonics technology and exclusive to Soundcraft. The Vi3000 uses Vistonics II as a core technology for console operation because of its significant user-interface benefits.

The Vistonics screens are divided into two main areas. The top section is the touch screen area and serves a number of functions. For instance, in the default input channel mode, the input touch screens show the Input, EQ, Dynamics, Bus outputs, and panning sections of input channel strip. Touching one of these opens that channel section onto the Vistonics VST area.

The VST area is the lower section of the Vistonics screens, each with two rows of eight VST Fields. Each VST Field contains an encoder, a button, and a display area. VST Fields are normally used for individual parameter control. For instance, the default input Vistonics screen uses the upper row of encoders to control a channel's contribution level to the Aux 1 bus, and the upper row of buttons to turn those contributions on and off.



Buttons On/Off



If a function is assigned to a button it is displayed as shown. The 'active' state shows the button highlighted in a lighter colour.

Open Touch Page



If the button can open a configuration page in the Touch area it shows a '+' sign on the button. If the configuration page is already open, the button will be labelled with a '-' sign. Pressing the button in that state will exit the configuration page.

Inactive Fields



If an audio function block is disabled, with the background of the field changed to grey, the button indication will change to a darker colour.



5.3: Console Bays



The Console is divided into four main bays. Counting from the left, the first, second, and fourth bays are Input Bays. The third bay is the Master Bay.

Input bays normally control input channels, however, they can have other functions mapped to them depending on how the console is being used. For example, you can map the bus masters, graphic EQ bands, matrix mix sources, aux bus contributions, and more to the input faders.

The input bay vistonics touch screen areas normally show eight channel-strip processing blocks for the eight corresponding faders. You can touch those processing blocks to focus the VST section (bottom part of screen populated with encoders and buttons) on that selection.

The input bay VST areas normally show Aux 1 and 2 contributions, though the functions of these encoders are also determined by the input channel VISTONICS button group.

The Master Bay contains assignable faders for the bus masters, plus the mix master (L, R, C) faders and the assignable monitor fader.

The Master Bay touch screen default display is an overview of metering for all input and output channels, as well as an as system message area and cue list.

The Master Bay VST area's default mapping is the first 16 bus masters. The next eight masters can be accessed with the [PAGE 2] button in the Master Bay VISTONICS button group.



5.3: Console Bays - Input Bay 3 Navigation

Touching a group of input channels or output bus masters meters in the Master Bay touch screen area immediately maps those channels to Input Bay 3.

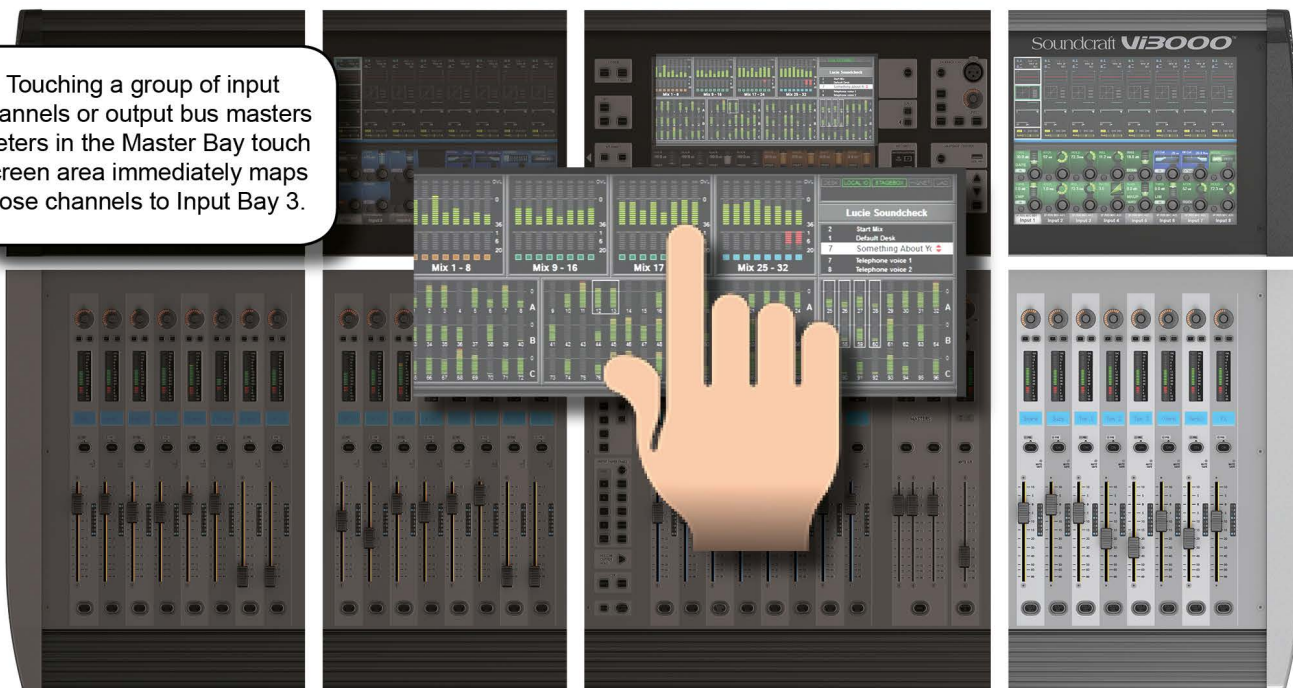

The Master Bay touch screen meters can be used as a navigation device - simply touch a block of eight meters and those channels (both inputs and outputs) are mapped to the right-hand input bay. This is excellent for fast access and for dual operator scenarios.

5.4: FaderGlow™

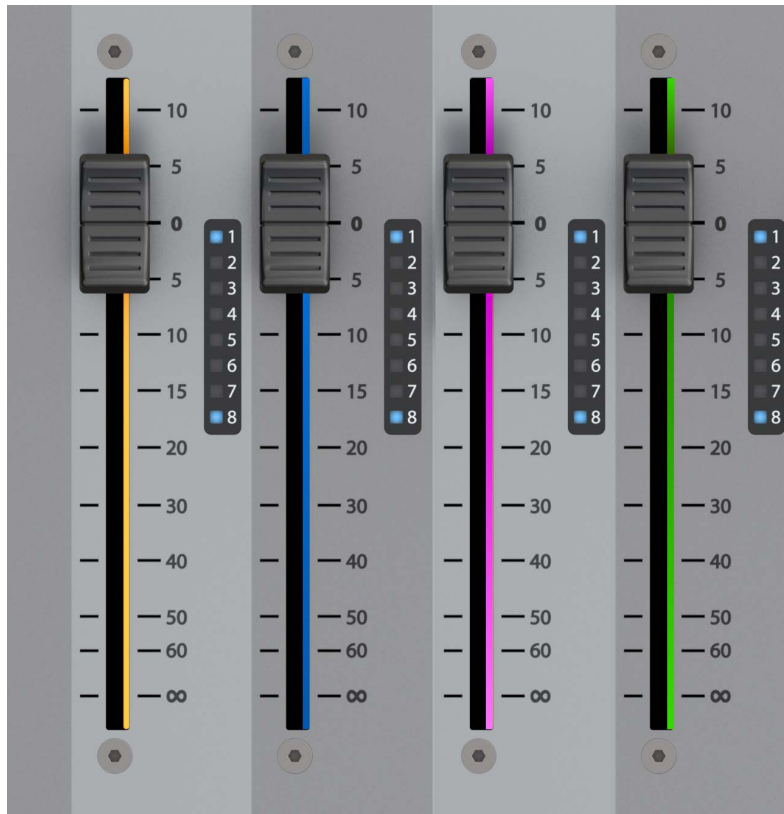

Soundcraft FaderGlow™ (Pat. Pend.) is a unique feature that gives the user an additional level of status indication, and can significantly reduce operating errors.

On the console, several different functions can be assigned to a particular fader, it can therefore be easy to forget which function is currently being controlled, especially when grabbing a fader in a hurry. The main principle of FaderGlow is therefore to indicate the actual function type that is currently assigned to a particular fader. Soundcraft FaderGlow is fitted to all 32 Faders that can change their function.

FADER OPERATION Soundcraft FaderGlow™ COLOUR

Channel level	NONE
AUX send level	ORANGE
GRP (fader closed)	GREEN
MTX contribution level	CYAN
VCA Master 1..8	BLUE
VCA Master 9..16	PINK
Aux VCA Master 1..16	WHITE

5.4: Buttons



There are a wide variety of button groups on the Vi3000. Below are described all button groups and selected individual buttons. Please refer to the relevant reference section for detailed information on the operation of all buttons.

Most buttons on the console can be latching (stay on) or Momentary (on when pressed, off when you let go) If you hold a button down it will have a momentary action. If you press a button and let go within half a second it will 'latch'.



System Button Group

[MUTE ALL O/P] (Mute All Outputs) and [POWER ON] buttons.



Edit Button Group

[COPY], [PASTE], and [UNDO] buttons.

These are used for copying and pasting whole channels, processing blocks, and individual parameters either elsewhere on the console or to and from the console's powerful library system. For more information see the Edit System reference chapter 13.





Input Channel VISTONICS Group

The input channel VISTONICS control buttons provide convenient ways of assigning bus master functions to the input channel VST encoders, such as selections for individual bus 'tap' points, and getting the input bus contribution shown on the VST screen to follow the master bus selection in the Master Bay.

For more information, see the Inputs reference chapter 6.



Output Vistonics Group

These buttons provide control over the VST section functionality of the Master Bay vistonics screens. For example, the [PAGE A] and [PAGE B] buttons switch the encoder section of the screen between busses 1-16 and 17-24. For More information, see Outputs Reference chapter 7.



Encoder Mode Buttons

These buttons assign various functions to the input channel strip encoders. For more information see the Inputs reference chapter 6.



Mute & VCA Groups

Control and assign the four mute groups and available 16 VCAs. For more information see the Mute & VCA Groups reference chapter 9.





Input Fader Pages

These buttons control navigation through five basic input channel Pages/Layers, including the 'All Busses' view, plus five user-definable pages. These buttons only affect the three input channel bays. For more information see the Input Channels reference chapter 6.



Output Fader Pages

Navigate through eight-wide pages of the console's output busses and VCA masters. These buttons only affect the Master Bay channel strips. For More information see the Output Channels reference chapter 7.



Next & Last

[NEXT] and [LAST] buttons for moving through the loaded Cuelist. These buttons have to be enabled in the Settings page of the main Menu. For more information see the Snapshots, Cuelist, and Global Filter reference chapter 14.



Snapshot Control

Full control over Snapshot and Cuelist storage, navigation, and recall. For more information see the Snapshots, Cuelist, and Global Filter reference chapter 14.



Talkback & Oscillator

Most of these buttons are dedicated to activating preset Talkback routings. To access Oscillator functions, use the [SETUP] button. For more information see the Talkback And Oscillotr reference chapter 15.



[SETUP] Buttons

Field / Group:

Active

	[SETUP] buttons open the relevant setup screen in the Master Bay Vistonics screen.	While a setup screen is active, pressing the [SETUP] button again will close that setup screen. For more information see the chapter relevant to each [SETUP] button.		Show Setup screen
---	--	---	--	-------------------

[SOLO/SEL] Buttons

Field / Group:

Inactive

Active

	Solo or select a channel.	The [SOLO/SEL] keys operate in two modes. The default function is to enable the SOLO path from its channel or bus to the monitoring system. However, if a touch-area page is open, pressing a [SOLO/SEL] from another channel (within its own bay of eight channels) moves the touch-area page to this new channel. [SOLO/SEL] buttons also perform other selection functions depending on the console mode. These are described in the relevant reference chapter.	Normal	Soloed/Selected
---	---------------------------	---	--------	-----------------

[GANG] Buttons

Field / Group:

Inactive

Active

	Special Ganging functionality.	For linking channels, processing blocks, and parameters, for convenient control. See the Gang section in this operations overview chapter for more information.	Normal	Gang Mode
--	--------------------------------	---	--------	-----------

[SOLO CLEAR] Button

Field / Group:

Active

	Clear any currently active console Solos.			Clear
---	---	--	--	-------



Lower [FLW] Button

	Field / Group:		Inactive	Active
	Input faders follow master bus selection.	<p>The fader FOLLOW OUTPUT SOLO [FLW] button located near the bottom of the Master Bay buttons strip causes the input faders to become contributions to an output bus when its [SOLO/SEL] button is pressed (often known as 'Sends on Faders mode').</p> <p>If a Matrix Output Solo/Sel is pressed, regardless of the setting of Follow Solo modes, the Output Solo will be activated, the EQ/Dyn/Misc touch screen for the Matrix Output displayed, and the channel faders will be assigned to the contribution levels from the Outputs to the Soloed Matrix Output.</p> <p>Note: the lower [FLW] key has an additional function in allowing VCAs to control the Aux sends of input channels. See the Mute & VCA reference chapter 9 for details.</p>	Follow Mode	Normal

Main Menu Button

	Field / Group:		Inactive	Active
	Brings up the Main Menu screen in the Master Bay.	Settings and preferences for a variety console functions are arranged in tabbed pages in the main menu. For more information, see the Main Menu reference chapter 16.	Normal	Main Menu Active

Input Priority

	Field / Group:		Inactive	Active
	Allow an Output Solo to remain active, whilst an Input Solo is temporarily activated 'over the top' of it.	For more information see the SOLO System reference chapter 8.	Normal	Main Menu Active

Lock Meters

	Field / Group:		Inactive	Active
	Locks the Meter section of the Master Bay touch screen onto the screen.	The meter section will be safe from output selections bringing the channel up on the touchscreen, for example. [SETUP] buttons still takeover the screen though.	Normal	Meters Locked



5.6: Encoders

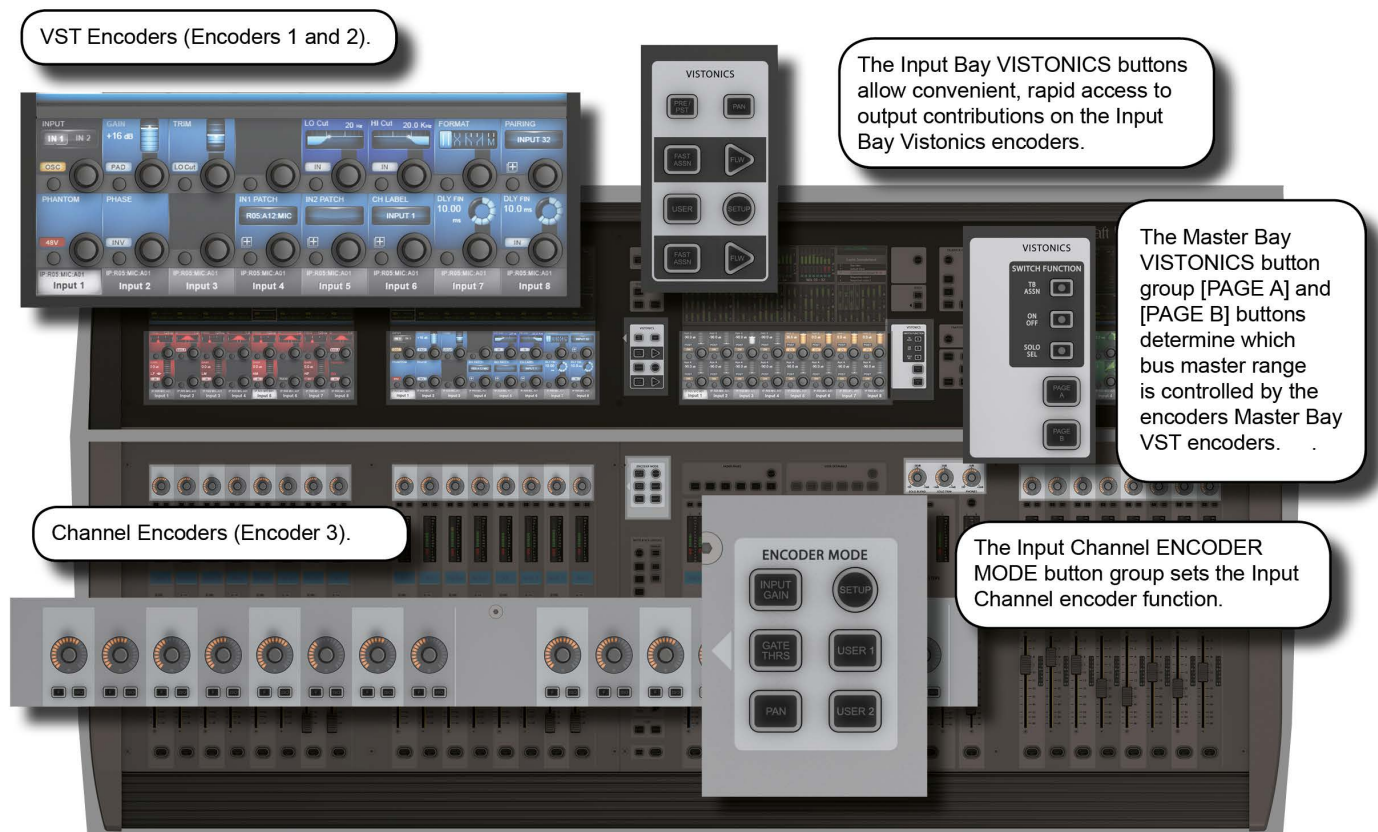

Each input channel strip contains three encoders: encoder 1 and encoder 2 are located in the VST fields in the lower screen area, while the channel encoder is located at the top of the fader area, and has an LED ring to indicate its parameter state. Each of these encoders can control different parameters, depending on the settings of other parts of the console.

The master section has 16 VST encoders and 4 panel-mounted encoders with LED rings: the TB/OSC Level Control encoder, and the Solo Blend, Solo Trim & Phones Volume encoders. These last four are dedicated to their respective functions.

Channel encoders always control a parameter on their own channel strip. The function of the channel encoders can be globally selected via the [INPUT GAIN], [GATE THRS] and [PAN] keys on the Encoder Mode panel. See the Inputs reference chapter 5 for more information.

The VST Input Bay encoders default to Aux 1 and 2, though can be assigned a variety of functions depending on the console mode. If any touch field is activated, the 16 VST encoders are assigned with expanded channel function parameters. See the Inputs reference chapter 5 for more information.

The default setting for the Master VST encoders is as the output level controls for Master Outputs 1-16. This can also be selected by pressing the [PAGE A] key on the Master Vistonics Mode Panel. Pressing [PAGE B] will cause the Master VST encoders to be assigned as the output level controls for Master Outputs 17-24.

The Master VST encoders can also be assigned to Master Output Expanded Functions (e.g. EQ, Dynamics, etc.). When a Master Output [SOLO/SEL] key is touched, it opens the Processing Area in the Master VST screen. If then a particular touch-area is touched, the VST encoders are assigned to appropriate expanded functions. For more information see Outputs reference chapter 6.

5.7: Gangs





Gang is a very helpful feature to speed up operations that influence functions on multiple input channels, or on output busses, in the same way. Any parameter change on ganged channels will be applied to all other ganged channels as an offset. For example, adding 4dB of level to an aux send on one channel will add 4dB of level to the the corresponding Aux sends on all other ganged channels - it will not 'copy' the actual level to the other ganged channels.

Button presses will change any corresponding buttons in ganged channels that are not currently in the new state, to the new state. From that point on, further presses will result in all switches changing state together.

Gang mode is activated and deactivated with the [GANG] button. You add or remove channels to or from the gang with the channel [SOLO/SEL] buttons.

Entering Gang Mode does not cancel any solos of any type that are active at the time. The Solo system continues to work as it was when Gang Mode was switched ON. The amber 'Solo' illumination of the Solo/Sel switches cannot be seen whilst gang mode is ON.

Gang Button	Field / Group:		Inactive	Active
	Activate or deactivate Gang Mode.	After activating Gang Mode, hold the [GANG] button down to Gang all channels. You can leave Gang Mode pressing the [Gang] button. If you haven't 'cleared down' the gang then it will be restored the next time you re-enter Gang Mode.	Normal	Gang Select

Select (Gang)	Field / Group:			Active
	Select and deselect ganged channels.	When in Gang Mode you can add single channels by pressing individual channels' [SOLO/SEL] buttons OR you can add a range of channels by pressing the first and last channels' [SOLO/SEL] buttons together. Press & Hold any [SOLO/SEL] button to clear down the entire gang (recommended after use to avoid accidental operation of Gang mode). When in a gang, a channel's [SOLO/SEL] button will glow blue.		Select Channel

5.8: Labelling



The console labelling system is displayed on a touch-screen area whenever the labelling of a channel, output, cue, file, or other named parameter or item is required. For example, you can label an input channel by touching the channel's input area on the touch screen then pressing the {CH LABEL} button in the VST area.

Labelling can be done with the displayed on-screen keyboard or an external USB keyboard. The on-screen keyboard is context sensitive and shows only the allowed character and symbols.

Long Labels can contain up to 10 characters and short labels can contain up to six characters.

6: Input Channels

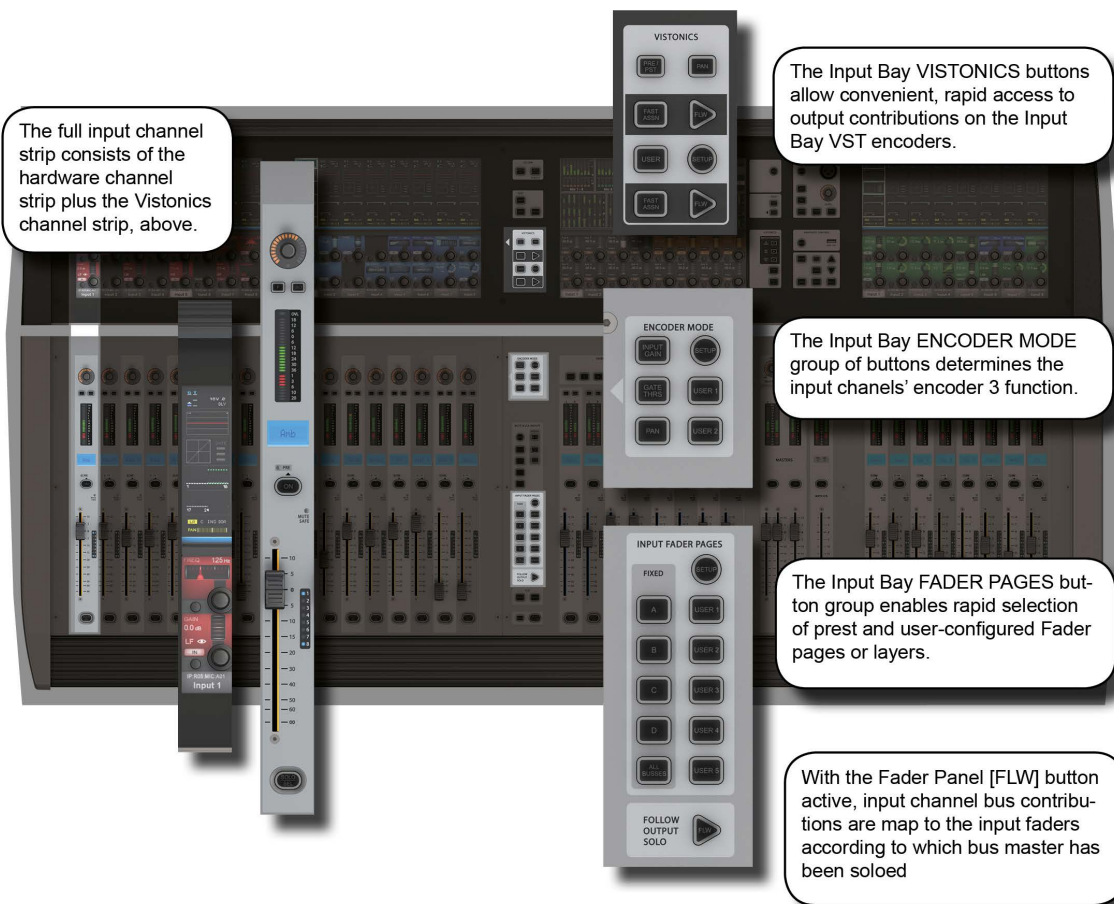
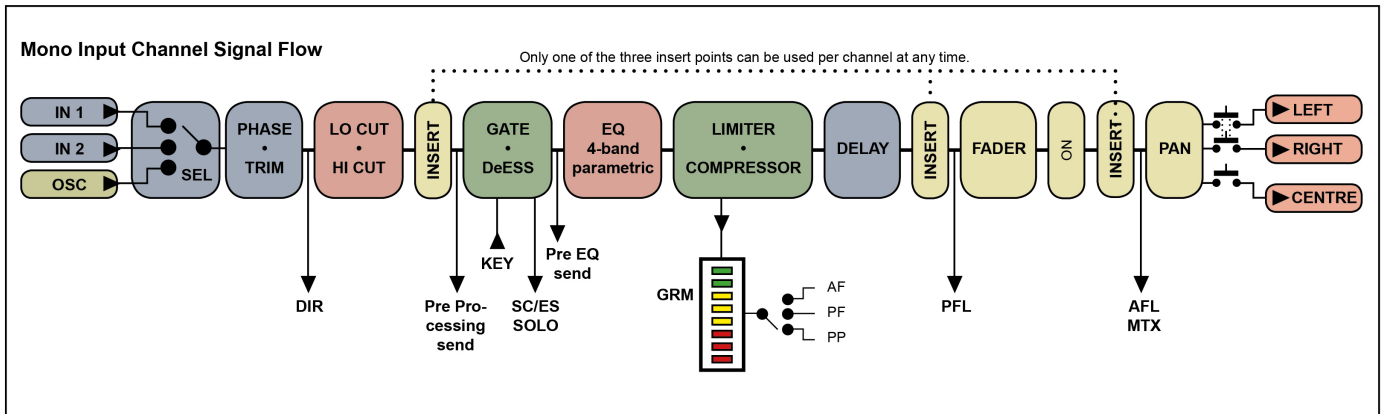

Bays 1, 2, and 4 of the console (Input Bays 1, 2, and 3) are normally dedicated to controlling input channels. However, other functions can be mapped to these channels, such as the Master Busses, Matrix feeds, Graphic EQ, and so on.

There are four main input channel control areas on the console:

- The main channel strips, including the Vistonics screen sections, are for control of input channel parameters, routing, and patching.
- The INPUT FADER PAGES buttons are for navigating the available input channels by choosing preset and user-definable fader pages.
- The input channel VISTONICS control buttons provide convenient ways of assigning bus master functions to the input channel VST encoders.
- The ENCODER MODE buttons provide fast switching of the channel strip encoder functions.

Navigating The Input Channels - Input Fader Pages

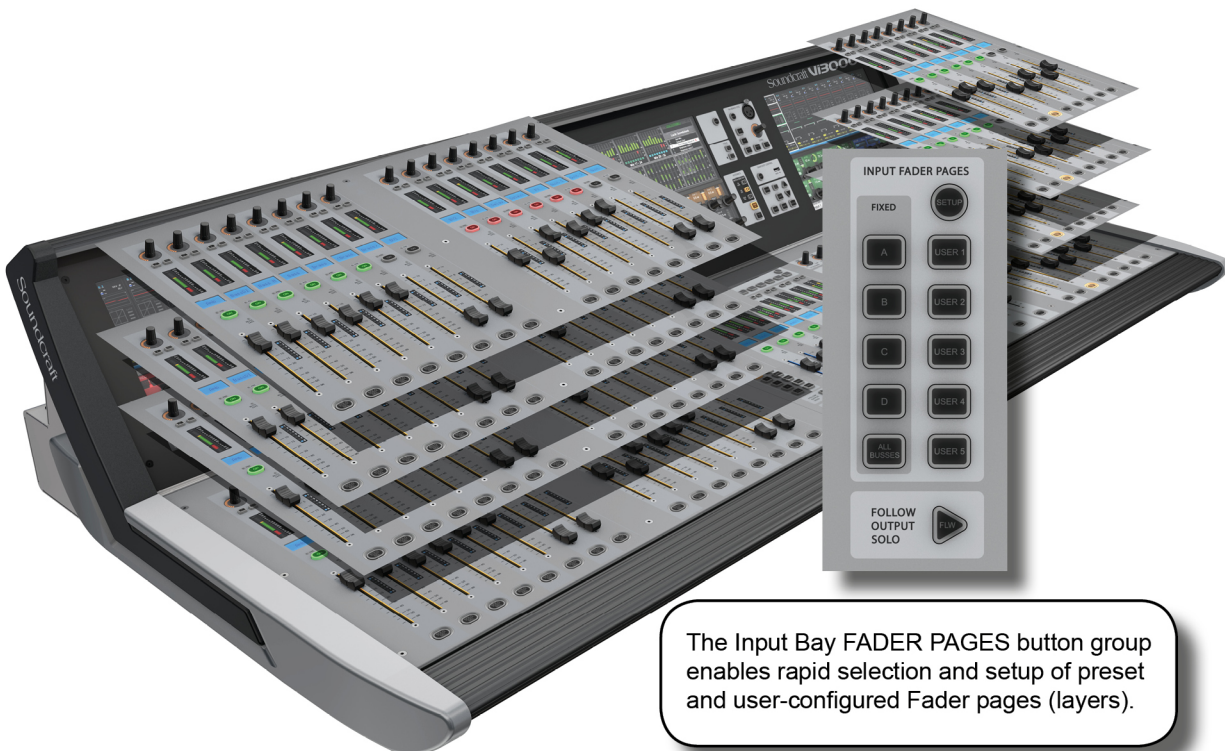

The Input Bay FADER PAGES button group enables rapid selection and setup of preset and user-configured Fader pages (layers).

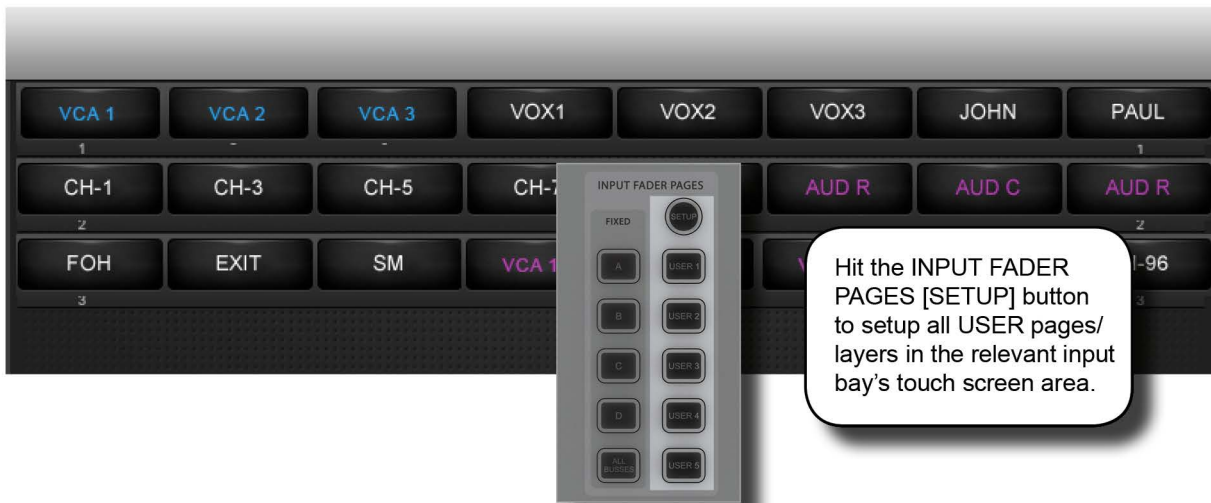

This section is used for navigating Fader Pages (or layers). There are four main layers of 24 input channel strips, and a further five user-definable layers available. The [ALL BUSES] button maps the output busses to the input channel strips, as described further in the Outputs reference section.

In addition, you can touch the input meter fields in the Master Bay Vistronics to remap those input channels to the right-most input bay.



Fixed Fader Layers

Field / Group: INPUT FADER PAGES

Active

	<p>Select four pages/layers of input channel strips.</p>	<p>Each button maps Pages of 24 channels to the three input bays, so [A] is channels 1-24; [B] is channels 25-48; [C] is channels 49-64; and [D] is channels 65-96.</p>		<p>Select</p>
---	--	---	--	---------------

User Fader Layers

Field / Group: INPUT FADER PAGES

Active

	<p>User-Defined input channel strip pages/layers</p>	<p>Select one of these buttons to map that user-defined fader-layer to the console. The User layers are defined by pressing the FADER PAGES [SETUP] button.</p>		<p>Select</p>
---	--	---	--	---------------

All Busses Mode

Field / Group: INPUT FADER PAGES

Active

	<p>Map the 24 output busses to the input bay fader strips.</p>	<p>See Outputs Reference section 7 for more detail on All Busses mode.</p>		<p>Select</p>
--	--	--	--	---------------



The Input Channel Strip

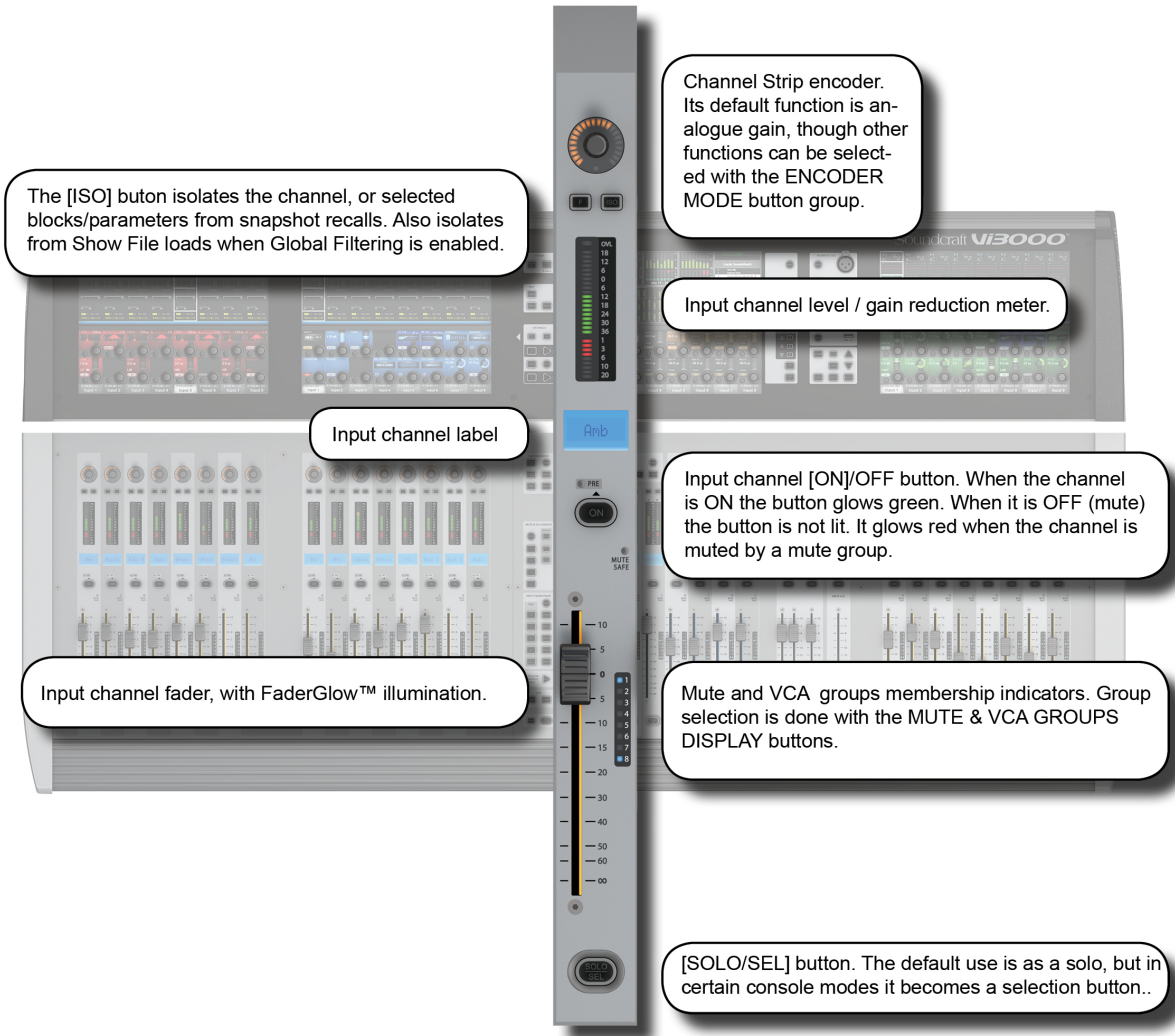

Input Channel Strip Encoder

	Field / Group:		Range Low	Range High
	Rotary control whose function is defined by the input ENCODER MODE buttons.	The Default function is control over the channel's analogue input gain. For more information see the Inputs Encoder Mode reference section 6.3	Dependant on Mode	Dependant on Mode

Input Channel Strip F

	Field / Group:			
	Reserved for future software updates			



Input Isolate

Field / Group:

Active

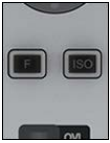
	<p>Used to isolate the channel (and selections) from snapshot recall and (when Global Filtering is active) from Show file loads.</p>	<p>See the Snapshot and Global Filtering reference section 14 for more information.</p>		<p>Isolate</p>
---	--	---	--	----------------

Level and GR Meter

Field / Group:

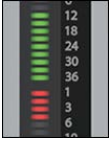
	<p>Level and gain reduction metering for the input channel.</p>	<p>See the metering reference section 12 for more information.</p>		
---	---	--	--	--

Input Channel Label

Field / Group:

	<p>Displays the short label/name of this channel.</p>	<p>The long and short channel labels are set in the channel's 'Input' Vistonics parameter block. See reference section 6.5.1 for more information.</p>		
--	---	--	--	--

'Pre' Indicator

Field / Group:

	<p>Reserved For Future Use.</p>			
---	---------------------------------	--	--	--

Channel ON/OFF

Field / Group:

Inactive

Active

	<p>Channel [ON]/OFF button. 'OFF' is effectively a mute control.</p>	<p>The button glows green when the channel is 'On'. If the channel is off there is no glow colour. However, if the channel is muted because a mute group has been activated, the [ON] button will glow red.</p>	<p>Channel Off</p>	<p>Channel On</p>
---	--	---	--------------------	-------------------

Mute Safe Indicator

Field / Group:

	<p>Glows red when Mute Safe is active for this channel.</p>	<p>When the Mute Safe system is enabled (in Monitoring section [SETUP]), then the channel strip SOLO/SEL button activates the Mute Safe status for the channel.</p>		
---	---	---	--	--



Mute/VCA Group Indicators

Field / Group:

	<p>Shows the Mute or VCA Groups that is channel belongs to.</p>	<p>The actual target of these LEDs (Mutes, VCAs 1-8, or VCAs 9-16) is determined by the DISPLAY buttons in the MUTE & VCA GROUPS button group. See the Mute & VCA Groups reference section 9 for more information.</p>		
---	---	--	--	--

Channel Fader

Field / Group:

	<p>Control the channel output level.</p>	<p>The input channel faders can also be assigned to follow the bus master selection in the Master Bay with the fader [FLW] button and become level controls for contributions to that bus.</p>		
---	--	--	--	--

FaderGlow

Field / Group:

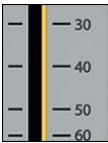
	<p>The channel fader is colour-coded depending on its function.</p>	<p>Input channel levels are not colour-coded. The other FaderGlow colours are Aux Sends: ORANGE; Groups: GREEN; Matrix Contribution: CYAN; VCA Master 1-8: BLUE; VCA Master 9-16: PINK.</p>		
--	---	---	--	--

Solo / Select

Field / Group:

Active

	<p>Default is the channel Solo function (listen to this channel only on the monitor bus).</p>	<p>If a touch-panel screen is open for the for another channel in the same bay, the [SOLO/SEL] button moves the touch screen to this channel. The button has other functions in other console modes such as selecting channel for a Copy or Paste edit function. Other functions for the [SOLO/SEL] button are detailed in the appropriate reference sections. For more on the console Solo System see reference section 11 for more information.</p>		<p>Solo Enable or Select</p>
---	---	---	--	------------------------------



Input Encoder Mode



The Input Bay ENCODER MODE group of buttons determines the input channels' encoder 3 function.

These buttons determine the function of the input channel encoder at the top of the main channel strip.

If [ALL BUSSES] is active or a Matrix output is soloed, the channel encoders are disabled and have no function (the previous function is remembered however).

Mode: Input Gain

Field / Group:

Active

	(Default) Switch the input Encoders to control analogue input gain.			Select Mode
---	---	--	--	-------------

Mode: Gate Threshold

Field / Group:

Active

	Switch the input Encoders to control Gate Threshold.			Select Mode
---	--	--	--	-------------

Mode: Pan

Field / Group:

Active

	Switch the input Encoders to control Pan.			Select Mode
---	---	--	--	-------------



Setup

Field / Group:

	Reserved for future software upgrade.			
---	---------------------------------------	--	--	--

Mode: User 1

Field / Group:

Active

	Switch the input Encoders to control Compressor Threshold.			Select Mode
---	--	--	--	-------------

Mode: User 2

Field / Group:

Active

	Switch the input Encoders to control Digital Trim.			Select Mode
--	--	--	--	-------------





Input VISTONICS Buttons (VST Section Control)



These buttons control the functionality of the input channel VST encoders.

You can easily and rapidly assign bus contributions and bus panning to the encoders using this button group.

Pre/Post	Field / Group:	Active
	Configure Aux sends from channels (when they are assigned to the two VST encoder rows), as pre or post-fader.	
VST Mode: Pan	Field / Group:	Active
	Activate aux panning for encoders where applicable.	If a stereo Aux is assigned to a VST encoder row, and if the [PAN] key is active, the encoder will control the Aux Pan rather than the contribution level. If both Auxes assigned to Row 1 & 2 are Stereo Auxes, both Rows 1 and 2 will change to the PAN function across the desk. If only one of the two rows is a Stereo Aux, then only this row will change to PAN. If neither row has a Stereo Aux assigned, the [PAN] switch will have no function.
Fast Assign	Field / Group:	Active
	Provides a very fast way to temporarily assign a bus function to a VST encoder row.	Press and hold one of the [FAST ASSN] keys, then press one of the Output Masters' [SOLO/SEL] keys. The relevant row of VST encoders will now be assigned to that Output master, and the [FAST ASSN] key in question will illuminate. There will be no influence on audio, the Output solo is not activated.



Encoders Follow Masters

Field / Group:		Inactive	Active
	Activate the FOLLOW SOLO function for the respective VST encoder rows.		Activate Mode
	Pressing a bus master [SOLO/SEL] button will automatically assign the soloed bus master to this row, overriding the default or the [USER] layer. Note that only one [FLW] can be active at a time.		

VST Mode: USER

Field / Group:		Inactive	Active
	Assign the two VST Encoder rows as AUX 3 and AUX 4 send level controls for their input channels.		Activate Mode

Input VST setup

Field / Group:		Inactive	Active
	Reserved for future use.		Activate Mode



Input Touch Screen Audio Blocks - INPUT

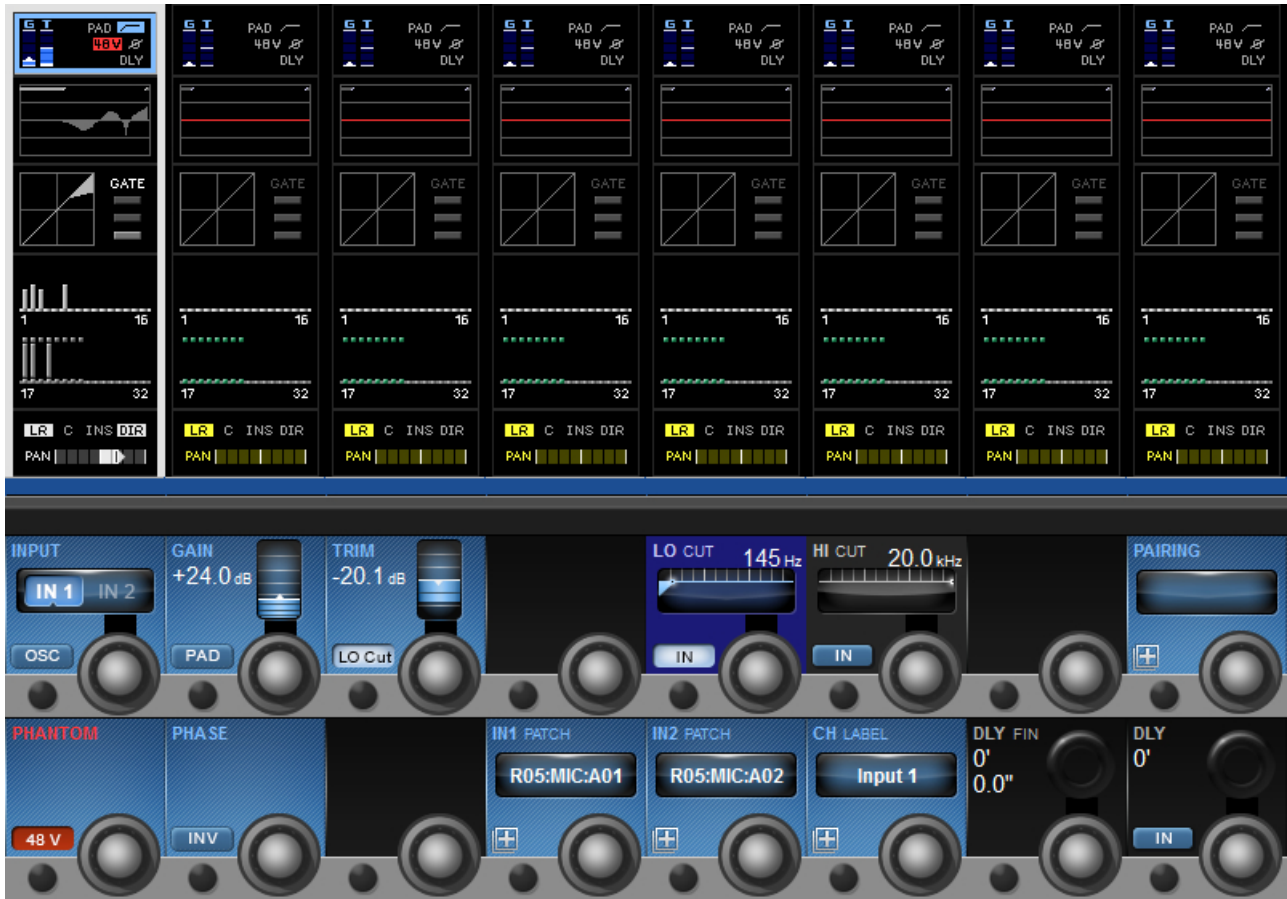

A mono input channel's input section touch screen area is at the top of the Vistonics input channel strip area, colour-coded blue. The input section consists of that channel's input source selection, pre-amp and gain stages control, channel pairing selection for stereo (and other format) channel creation, channel labelling, and channel delay adjustment.



Channel Input Select

Field / Group: INPUT

Range Low

Range High

	<p>Select either Input 1 or Input 2 as the channel input.</p>	<p>The two physical channel inputs are assigned in the IN1 PATCH and IN2 PATCH fields.</p>	<p>IN 1</p>	<p>IN 2</p>
---	---	--	-------------	-------------

Oscillator Input Select

Field / Group: INPUT

Inactive

Active

	<p>Assign the console's central oscillator to the input of this channel.</p>	<p>When OSC is active, the normal input selections are disabled and the corresponding input touch field is highlighted in orange.</p>	<p>off</p>	<p>on</p>
---	--	---	------------	-----------

Input Gain

Field / Group: GAIN

Range Low

Range High

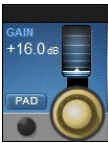
	<p>Adjust the analogue input gain.</p>	<p>This is an analogue gain stage, before analogue-to-digital conversion.</p>	<p>+10dB</p>	<p>+65dB</p>
--	--	---	--------------	--------------

Input Pad

Field / Group: GAIN

Inactive

Active

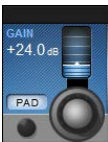
	<p>Reduce the input sensitivity by 20dB.</p>	<p>When the Pad is active, the PAD text in the input touch field is highlighted in blue.</p>	<p>0dB</p>	<p>-20dB</p>
---	--	--	------------	--------------

Input Trim

Field / Group: TRIM

Range Low

Range High

	<p>Adjust the digital input gain.</p>	<p>This is the post analogue-to-digital conversion gain, in the digital domain.</p>	<p>-36dB</p>	<p>+15dB</p>
---	---------------------------------------	---	--------------	--------------

Analogue Lo Cut filter

Field / Group: TRIM

Inactive

Active

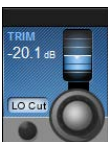
	<p>Insert the analogue (pre AD converter) low cut filter (only analogue inputs).</p>	<p>When the analogue LO Cut filter is engaged, the LO Cut symbol in the input touch field is highlighted in blue. This filter affects analogue inputs only.</p>	<p>Out</p>	<p>In</p>
---	--	---	------------	-----------



LO CUT Cut-Off Frequency

Field / Group: LO CUT

Range Low

Range High

	<p>Adjusts the LO CUT cut-off frequency</p>	<p>This is part of the digital (post AD) LO CUT / HIGH CUT section and affects all inputs. The affected frequency range is shown graphically in the EQ section of the touch screen.</p>	<p>20Hz</p>	<p>600Hz</p>
---	---	---	-------------	--------------

LO CUT IN

Field / Group: LO CUT

Range Low

Range High

	<p>Switch the digital LO CUT filter in and out</p>	<p>When the digital LO CUT filter is switched in, the LO CUT indicator above the response graph in the EQ touch section is highlighted in blue.</p>	<p>Out</p>	<p>In</p>
---	--	---	------------	-----------

HI CUT Cut-Off Frequency

Field / Group: HI CUT

Range Low

Range High

	<p>Adjusts the HI CUT filter cut-off frequency.</p>	<p>This is part of the digital (post AD) LO CUT / HIGH CUT section and affects all inputs. The affected frequency range is shown graphically in the EQ section of the touch screen.</p>	<p>1kHz</p>	<p>20kHz</p>
--	---	---	-------------	--------------

HI CUT IN/OUT

Field / Group: HI CUT

Range Low

Range High

	<p>Switch the digital HI CUT filter in and out</p>	<p>When the digital HI CUT filter is switched in, the HI CUT indicator above the response graph in the EQ section of the touch screen is highlighted in blue.</p>	<p>OUT</p>	<p>IN</p>
---	--	---	------------	-----------

Channel Pairing Selection

Field / Group: PAIR-ING

Inactive

Active

	<p>Activate channel pairing selection on touch screen.</p>	<p>The touch screen will show pairing candidate options for the channel - these will be consecutive channel numbers (horizontal neighbours) and the corresponding channels on higher and lower layers (vertical neighbours). All channel parameters will be copied to the selected pairing candidate and the pairing FORMAT field will be displayed.</p>	<p>No Selection</p>	<p>Channel Selection</p>
---	--	--	---------------------	--------------------------

Pairing Format Selection

Field / Group: FOR-MAT

Range Low

Range High

	<p>Adjusts stereo format of paired channels.</p>	<p>The choices are LR, RL, LL, RR, MONO. If the channel is not paired, the FORMAT field will not be displayed.</p>	<p>LR</p>	<p>MONO</p>
---	--	--	-----------	-------------



Phantom Power		Field / Group: PHANTOM	Inactive	Active
	Apply Phantom Power (+ 48V) to XLR patched to this input.	When phantom power is applied to this channel's input, the '48V' indicated (touch screen input section) is highlighted in red.	Off	48V
Phase Invert		Field / Group: PHASE	Inactive	Active
	Invert the phase of audio through this channel.	When phase invert is active, the phase symbol in the input section of the touch screen is highlighted blue.	Off	180 degrees
Input Patch		Field / Group: IN1 PATCH / IN 2 PATCH	Inactive	Active
	Activate input patching selection on touch screen.	The input patch selection screen will give you access to all available inputs / sources, both external (local I/O, Stage Box, MADI, and so on) and internal (Lexicon effects). If an input channel is paired, you will also have to option to select L or R assignment from the same screen. The IN 1 and IN 2 field text areas will show the selected source.	Inactive	Selection active
Channel Label		Field / Group: CH LABEL	Inactive	Active
	Activate channel labeling functionality on main touch screen.	This control brings up the standard ASCII keyboard display and colour selector in order to label the channel. You can specify short and long channel names, and a label colour. You can also use a connected USB keyboard if available.	Inactive	Active
Delay Fine Adjust		Field / Group: DLY FIN	Range Low	Range High
	Fine adjustment of the channel delay time.	Adjusts overall delay time in small steps. The delay units (feet, meters, seconds etc) of adjustment can be changed in the main Settings screen, via the [MENU] button.	0 Seconds	
Delay Adjust		Field / Group: DLY	Range Low	Range High
	Adjustment of the channel delay time.	Adjusts overall delaytime. The delay units (feet, meters, seconds etc) can be changed in the main Settings screen, via the [MENU] button.	0 Seconds	MONO
Delay In / Out		Field / Group: DLY	Range Low	Range High
	Activates the delay for this channel.	When the channel delay is active, the 'DLY' indicator in the touch screen input area is highlighted blue.	Out	In

Input Touch Screen Audio Blocks - EQ



A mono input channel's parametric EQ section touch screen area is near the top of the Vistonics input channel strip area, colour-coded red. The EQ section consists of four parametric bands with shelving response available to the LF and HF bands..



Frequency Control

Field / Group: **FREQ**

Range Low

Range High

	<p>Adjust the centre frequency (band pass) or cut-off frequency (shelving) of the EQ.</p>	<p>All changes are reflected in the graphic Vistronics touch screen EQ section. Any band currently being adjusted is shown highlighted in white. All four bands feature full-range frequency control.</p>	<p>20Hz</p>	<p>20kHz</p>
---	---	---	-------------	--------------

EQ Bandwidth / Q Control

Field / Group: **BwOct**

Range Low

Range High

	<p>Adjust the bandwidth or Q (inverse) of the current filter.</p>	<p>You can chose whether the adjustment unit is Bandwidth or Q via the main settings screen by hitting the [menu] button.</p>	<p>0.3Q/0.2oct</p>	<p>8.7Q/4oct</p>
---	---	---	--------------------	------------------

Shelf Select

Field / Group: **BwOct/Q**

Inactive

Active

	<p>Choose a shelving response for the filter.</p>	<p>The shelf response is available to the high (HF) and low (LF) EQ bands.</p>	<p>Bell</p>	<p>Shelf</p>
---	---	--	-------------	--------------

Gain Control

Field / Group: **GAIN**

Range Low

Range High

	<p>Adjust the gain applied to the defined filter band.</p>		<p>-18dB</p>	<p>+18dB</p>
---	--	--	--------------	--------------

EQ Band In

Field / Group: **GAIN**

Inactive

Active

	<p>Switch the selected EQ band into the Equaliser signal path.</p>	<p>Please note, there is also an EQUALISER IN button to switch the equaliser section into the channel signal path.</p>	<p>Out</p>	<p>In</p>
---	--	--	------------	-----------

Flatten All

Field / Group:

Active

	<p>Flatten settings for the whole equaliser section.</p>			<p>Flatten</p>
---	--	--	--	----------------

EQ In

Field / Group: **EQUALISER**

Inactive

Active

	<p>Switch the whole equaliser section into and out of the channel signal path.</p>	<p>Respects in/out settings on individual bands. When the Equaliser section is 'In' the EQ graphic on the Vistronics input channel touch screen area will be highlighted in red.</p>	<p>Out</p>	<p>In</p>
---	--	--	------------	-----------



Input Touch Screen Audio Blocks - Dynamics



The dynamics section has three main components - The first can either be a GATE or DeEsser section; the other two are a COMPRESSOR and a LIMITER. All three sections can be turned on or off independently.

The dynamics section of the Vistonics touch screen shows gain reduction as a compression transform, and Gate/DeEss selection. It also shows either the Gate status, or a gain reduction meter, depending on the Gate / DeEss selection.



Gate

A gate is a threshold driven gain reduction process normally used to reduce the level of, or silence, a signal when it falls below the threshold. The gate section includes an assignable side-chain input with filters, a key signal solo function, and a ducking mode.

Gate / DeEsser Selection

Field / Group: MODE

Range Low

Range High

	<p>Select either the GATE or DeEsser function for the first dynamics process.</p>	<p>The top line of dynamics controls adapt to this selection.</p>	<p>Gate</p>	<p>DeEsser</p>
---	---	---	-------------	----------------

Gate Threshold Set

Field / Group: GATE

Range Low

Range High

	<p>Adjust the gate threshold level.</p>		<p>-40dB</p>	<p>+18dB</p>
---	---	--	--------------	--------------

Gate In

Field / Group: GATE

Inactive

Active

	<p>Include the Gate in the dynamics signal path.</p>	<p>When Gate In is selected, the word 'GATE' is highlighted in the touch screen dynamics section.</p>	<p>Out</p>	<p>In</p>
---	--	---	------------	-----------

Gate Attack Time

Field / Group: ATCK

Range Low

Range High

	<p>Adjust the attack time of the Gate.</p>		<p>10uS</p>	<p>957mS</p>
---	--	--	-------------	--------------

Gate Duck Function

Field / Group: ATCK

Inactive

Active

	<p>Select the Gate DUCK mode.</p>	<p>DUCK mode in inverse gate mode which reduces level when the side chain input EXCEEDS the threshold. This can be used for 'ducking' a music bed under a DJ vocal, for instance.</p>	<p>Off</p>	<p>On</p>
---	-----------------------------------	---	------------	-----------

Gate HOLD function

Field / Group: HOLD

Range Low

Range High

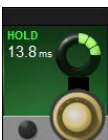
	<p>Adjust the Gate Hold Tim</p>	<p>This is the time an activated gate will remain fully closed, before entering the 'release' phase.</p>	<p>2.2 mS</p>	<p>2 seconds</p>
---	---------------------------------	--	---------------	------------------



Gate Release Time

Field / Group: REL

Range Low

Range High

	<p>Adjust the Gate Release Time</p>	<p>This is the time an activated gate will take to open, from its 'hold' state.</p>	<p>2.2 mS</p>	<p>3.7 Sec</p>
---	-------------------------------------	---	---------------	----------------

Gate Range

Field / Group: RNG

Range Low

Range High

	<p>Adjust the Gate Range.</p>	<p>This is the difference between the normal signal level and the gated signal level.</p>	<p>-60dB</p>	<p>0dB</p>
---	-------------------------------	---	--------------	------------

Gate Side Chain Solo

Field / Group: RNG

Inactive

Active

	<p>Switches the Gate Side Chain signal to the Solo buss.</p>	<p>For monitoring the signal being used as the gate 'key' (The signal used for testing gate threshold).</p>	<p>Off</p>	<p>Solo</p>
--	--	---	------------	-------------

Lo Cut Frequency

Field / Group: LO CUT

Range Low

Range High

	<p>Adjust the cut-off frequency of the gate sidechain lo-cut filter.</p>	<p>Together with the gate hi-cut filter, this creates a band-pass filter for side chain control of the gate.</p>	<p>20Hz</p>	<p>20kHz</p>
---	--	--	-------------	--------------

Sidechain Filter In

Field / Group: LO CUT

Inactive

Active

	<p>Inserts the gate Hi and Lo Cut side chain filters into the side chain signal path.</p>	<p>Together the gate lo-cut and high-cut side chain filters, create a band-pass filter for side chain control of the gate.</p>	<p>Out</p>	<p>In</p>
---	---	--	------------	-----------

Gate Hi Cut Filter

Field / Group: HI CUT

Range Low

Range High

	<p>Adjust the cut-off frequency of the gate sidechain hi-cut filter.</p>	<p>Together with the gate lo-cut filter, this creates a band-pass filter for side chain control of the gate.</p>	<p>20Hz</p>	<p>20kHz</p>
---	--	--	-------------	--------------

Gate External Key In

Field / Group: HI CUT

Inactive

Active

	<p>Switches the sidechain key signal from the main channel signal, to an external signal.</p>	<p>Assign the key input patch with the key assign button in the MODE field.</p>	<p>Out</p>	<p>In</p>
---	---	---	------------	-----------



External Key Assign

Field / Group: MODE

Inactive

Active

	<p>Activate the External Key Assign screen in the main Vistonics touch screen panel.</p>	<p>All external I/O options for the external key become available for selection.</p>	<p>+</p>	<p>-</p>
---	--	--	----------	----------

DE-ESS Function

The de-esser is a dynamically controlled filter normally used to reduce the sibilance ('sss' components) in a singer's voice. If the de-esser is active, the signal level will be reduced only in the band set by the filters, when the signal in this band exceeds the required threshold.

De-Esser Sensitivity

Field / Group: SENS

Range Low

Range High

	<p>Adjust the sensitivity of the De-esser process.</p>		<p>0%</p>	<p>100%</p>
---	--	--	-----------	-------------

De-Esser In

Field / Group: DEES

Inactive

Active

	<p>Activates the De-esser process</p>		<p>Out</p>	<p>In</p>
---	---------------------------------------	--	------------	-----------

De-Esser Range

Field / Group: RNG

Range Low

Range High

	<p>Adjusts the De-esser attenuation.</p>	<p>The maximum amount by which the signal in the 'Ess' band is attenuated when the DeEsser is activated.</p>	<p>-18dB</p>	<p>0dB</p>
---	--	--	--------------	------------

Ess Band Solo

Field / Group: RNG

Inactive

Active

	<p>Solo the De-esser dynamic filter.</p>	<p>Helps pinpoint the 'Ess band' most suited to the current signal.</p>	<p>Off</p>	<p>Solo</p>
---	--	---	------------	-------------

De-Ess Filter Frequency

Field / Group: FREQ

Range Low

Range High

	<p>Adjust the centre frequency of the De-ess dynamic filter.</p>		<p>20Hz</p>	<p>20kHz</p>
---	--	--	-------------	--------------



**De-Ess Filter
Bandwidth**

Field / Group: BwOct

Range Low

Range High

	<p>Adjust the bandwidth or Q of the De-esser dynamics filter</p>	<p>You can set the unit of adjustment (octave bandwidth or Q) in the main Settings screen, activated with the [menu] button.</p>	<p>0.2oct / 0.3Q</p>	<p>4oct / 8.7Q</p>
---	--	--	----------------------	--------------------

Compressor / Limiter

A compressor is a threshold driven process used to reduce the dynamic range of a signal by applying gain reduction when the signal level exceeds the threshold and applying 'make-up gain' to keep the overall level consistent. The compressor includes an automatic make-up gain function.

A Limiter is a dynamics process used to limit peak signal level by reducing signal level as it approaches or exceeds the threshold.

**Compressor
Threshold**

Field / Group: CMP

Range Low

Range High

	<p>Adjust the threshold of the compressor</p>	<p>When the signal exceeds the threshold, it will be attenuated according to the compression settings.</p>	<p>-40dB</p>	<p>+18dB</p>
---	---	--	--------------	--------------

Compressor In

Field / Group: CMP

Inactive

Active

	<p>Activate the compressor process.</p>	<p>The the compression process is activated, the compression transform graphic in the dynamics touch screen area will be highlighted in green.</p>	<p>Out</p>	<p>In</p>
---	---	--	------------	-----------

**Compressor
Attack**

Field / Group: ATCK

Range Low

Range High

	<p>Adjust the compressor attack time.</p>	<p>The time it takes for the compression function to reach full attenuation after the threshold has been reached. The slower the attack time, the 'softer' the compression.</p>	<p>0.5mS</p>	<p>98.6mS</p>
---	---	---	--------------	---------------

**Compressor Re-
lease Time**

Field / Group: REL

Range Low

Range High

	<p>Adjust the compressor release time.</p>	<p>The time it takes for the compression function to return to zero attenuation after full attenuation has been reached.</p>	<p>5.5mS</p>	<p>5 Sec</p>
---	--	--	--------------	--------------

**Compressor Re-
lease Time**

Field / Group: REL

Range Low

Range High

	<p>Adjust the compressor release time.</p>	<p>The time it takes for the compression function to return to zero attenuation after full attenuation has been reached.</p>	<p>5.5mS</p>	<p>5 Sec</p>
---	--	--	--------------	--------------



Compression Ratio

Field / Group: RTIO

Range Low

Range High

	<p>Adjust the compression ratio.</p>	<p>The ratio between the normal signal level and the attenuated (compressed) signal level. The higher the ratio, the more compression is applied.</p>	<p>1</p>	<p>20</p>
---	--------------------------------------	---	----------	-----------

Compressor Makeup Gain

Field / Group: MKUP

Range Low

Range High

	<p>Adjust the post-compression makeup gain.</p>	<p>Gain applied after the compressor to account for level lost in compression.</p>	<p>-20dB</p>	<p>+20dB</p>
---	---	--	--------------	--------------

Compressor Automatic Makeup Gain

Field / Group: MKUP

Inactive

Active

	<p>Activate automatic makeup gain.</p>	<p>When activated, this will apply makeup gain after the compressor automatically, depending on the settings of the Threshold and Ratio controls.</p>	<p>Off</p>	<p>On</p>
---	--	---	------------	-----------

Limiter threshold

Field / Group: LIM

Range Low

Range High

	<p>Adjust Limiter threshold.</p>	<p>Threshold at which the limiter is activated.</p>	<p>-40dB</p>	<p>-6dB</p>
---	----------------------------------	---	--------------	-------------

Limiter In

Field / Group: LIM

Inactive

Active

	<p>Activate Limiter</p>	<p>Include the Limiter in the dynamics section.</p>	<p>Out</p>	<p>In</p>
---	-------------------------	---	------------	-----------

Limiter Attack Time

Field / Group: ATCK

Range Low

Range High

	<p>Adjust the Limiter attack time.</p>	<p>The time taken for the limiter to reach full attenuation.</p>	<p>10uS</p>	<p>98.6mS</p>
---	--	--	-------------	---------------

Limiter Release Time

Field / Group: REL

Range Low

Range High

	<p>Adjust the Limiter release time.</p>	<p>The time taken for the limiter to return to zero attenuation after limiting.</p>	<p>5.5mS</p>	<p>957mS</p>
---	---	---	--------------	--------------

Input Touch Screen Audio Blocks - Busses



The Busses section of the input channel vistonics touch screen signal path provides access to all Aux and Group contributions in the VST area. The Touch Screen block graphic shows activated Aux levels in orange and group routings in Green. The controls vary depending on whether you are working on Auxiliaries or groups.

Auxiliary Send Level

	Field / Group: Aux n		Range Low	Range High
	Adjust the send level from the input channel to the numbered Aux Bus.	The Orange bars in the bus touch screen areas show also aux send levels. The control display includes post / pre-fade routing of the aux buss.	-90dB	+10dB

Auxiliary Send On

	Field / Group: Aux n		Inactive	Active
	Enables the numbered aux send from the input channel.	The corresponding aux level bar in the bus touch screen area is highlighted orange when the aux send is enabled.	Off	On



Stereo Aux Send Balance

Field / Group: Aux n

Range Low

Range High

	<p>Adjust balance of the numbered stereo aux send.</p>	<p>The Stereo symbol above the encoder shows that this aux send has been combined with its numerical neighbour to create a stereo aux send. The 'neighbour' aux send space will either be blank or show a balance control, depending on the busses' 'channel pan' status. If the aux has been set to follow the input channel panning, there will be no balance control.</p>	<p>30L</p>	<p>30R</p>
---	--	--	------------	------------

Group Buss Routing

Field / Group: Group n

Inactive

Active

	<p>Route the input channel signal to the numbered group bus.</p>	<p>The corresponding group assign bar in the bus touch screen area is extended and highlighted in blue when the numbered groups bus routing is enabled for this channel.</p>	<p>Off</p>	<p>On</p>
---	--	--	------------	-----------

Stereo Group Buss Routing

Field / Group: Group n

Inactive

Active

	<p>Route the input channel signal to the numbered stereo group bus.</p>	<p>The Stereo symbol above the encoder indicates that this group has been paired with its neighbour to create a stereo group buss that follows channel panning. The neighbouring group display will be blank.</p>	<p>Off</p>	<p>On</p>
--	---	---	------------	-----------

Buss 'Blank'

Field / Group:

Inactive

Active

	<p>Shows this buss has been assigned as a Matrix buss.</p>		<p>-</p>	<p>-</p>
---	--	--	----------	----------

Input Touch Screen Audio Blocks - Panning, Insert, Direct Out, Delay.

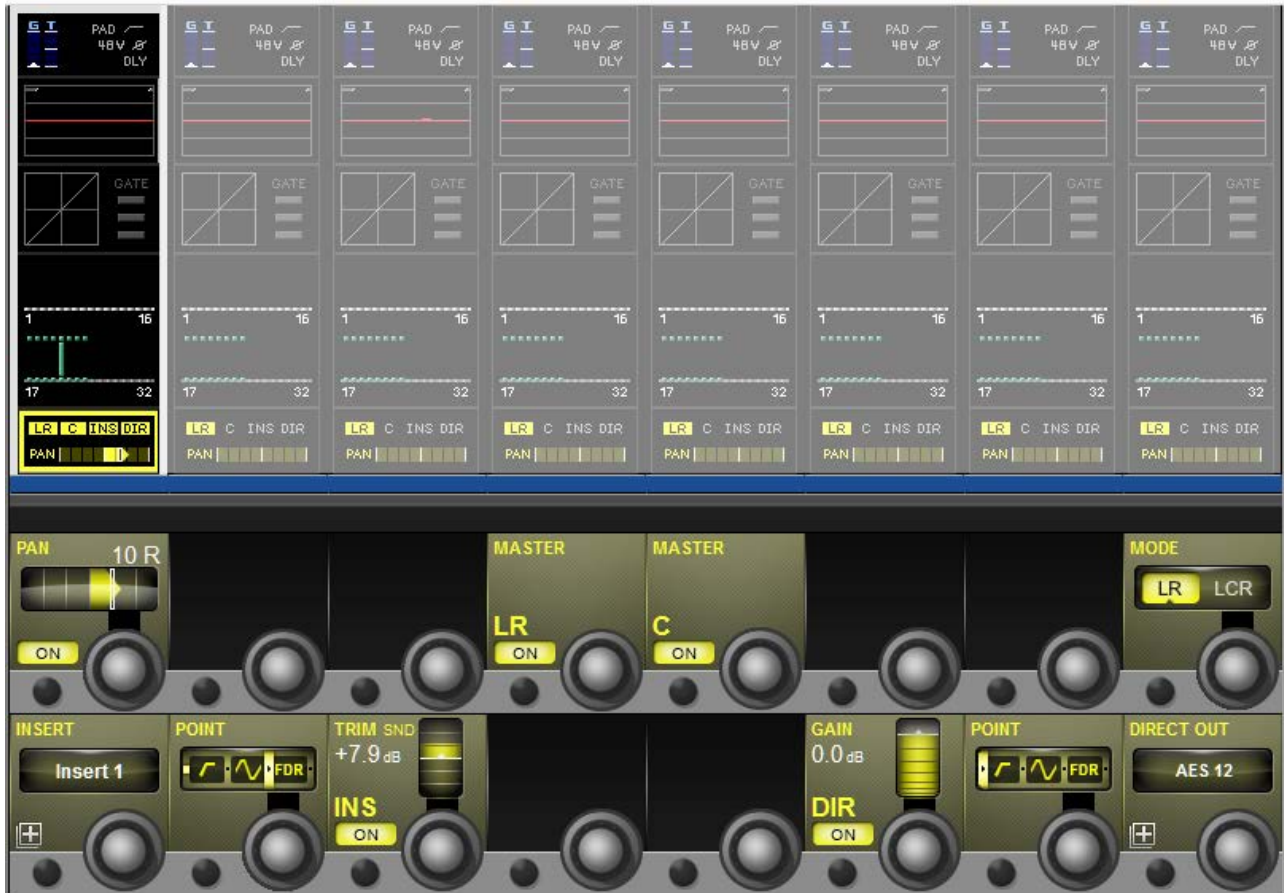





This page contains the output functions of the input channel including the panning, the routing to the mix masters, and the insert point and the direct out parameters. The Pan can work in LR or in LCR mode. In LCR mode an additional width function is available.







Panning	Field / Group: PAN		Range Low	Range High
	Adjusts panning to the Master L, R, and C busses, depending on pan mode chosen.	If the channel is paired, the balance can be adjusted. If the Pan {MODE} is set to LCR, an additional WIDTH field becomes available.	30L	30R

Panning On	Field / Group: PAN		Inactive	Active
	Activate or deactivate the panning controls.	If PAN is set to OFF, then the level to all master busses is the same as if pan controls are 'middled'. That is -3dB for mono channel panning and 0dB for paired channel balance. If PAN is set to ON then the level to the master busses varies between 0dB and -infinity. For balance that becomes +3dB to -infinity.	Off	On



<p>LR On</p> 	<p>Field / Group: MASTER LR</p> <p>Routes the channel signal to the Left and Right masters.</p>		<p>Inactive</p> <p>Off</p>	<p>Active</p> <p>On</p>
<p>Centre On</p> 	<p>Field / Group: MASTER C</p> <p>Routes the channel signal to the Centre master bus.</p>		<p>Inactive</p> <p>Off</p>	<p>Active</p> <p>On</p>
<p>Panning Mode</p> 	<p>Field / Group: MODE</p> <p>Set either LR or LCR Mode.</p>	<p>In LR Mode only Pan is available, though routing to the C master bus is still possible. With LCR mode enabled, the width parameter becomes available.</p>	<p>Range Low</p> <p>LR</p>	<p>Range High</p> <p>LCR</p>
<p>Insert Patch</p> 	<p>Field / Group: INSERT</p> <p>Select and assign physical I/O for the insert send and return.</p>	<p>Insert points provide a send and return path that interrupts the channel signal flow.</p> <p>In any Insert Select page, all available insert points can be patched to physical I/O by touching the on-screen (SETUP) button. You can return to insert assignment by touching the (SETUP) button again. In Insert SETUP mode you can choose send and return I/O from any of the available physical inputs and outputs, and you can pair inserts.</p> <p>You can assign input channel inserts to any unused insert point or to an available internal FX unit. If you try to select an insert point that has already been assigned, you will be offered the option to 'steal' that insert.</p>	<p>Active</p> <p>Close Patching Screen.</p>	<p>Open Patching screen.</p>
<p>Insert Point</p> 	<p>Field / Group: POINT</p> <p>Select the point in the input channel's signal path for the insert point 'tap'.</p>	<p>Options are post-HPF/Pre-processing, post-processing/pre-fader, or post-fader.</p>		



Insert Trim	Field / Group: TRIM		Range Low	Range High
	Adjust the actual send signal level.			
Insert On	Field / Group: TRIM		Inactive	Active
	Activate the insert point.		Off	On
Direct Output On	Field / Group:		Inactive	Active
	Activate the Direct Output for this input channel.		Off	On
Direct Output Gain	Field / Group:		Range Low	Range High
	Adjust the gain of the channel's Direct Output.		-90dB	+10dB
Direct Output Point	Field / Group:			
	Select the point in the input channel's signal path for the Direct Output 'tap'.	Options are pre HPF, post-HPF/Pre-processing, post-processing/pre-fader, or post-fader.		
Direct Output Patch	Field / Group: DIRECT OUT		Inactive	Active
	Select and assign physical I/O for the direct output.	Opens a patching screen in the corresponding Vistonics touch screen area.	Close Patch Screen	Open Patch Screen

Outputs

Auxilliaris, Groups, and LCR Mix busses

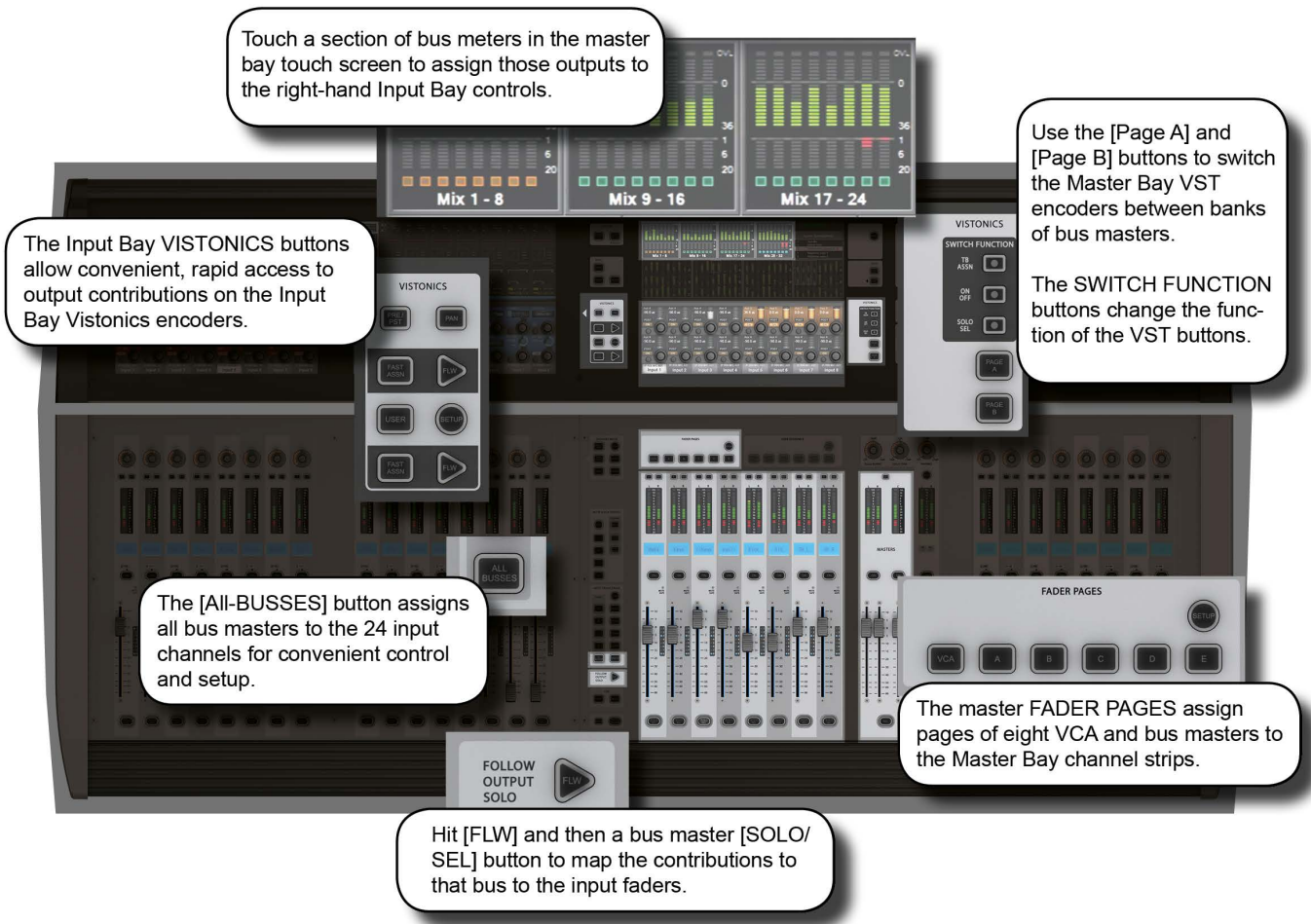

Bus Master Signal Flow

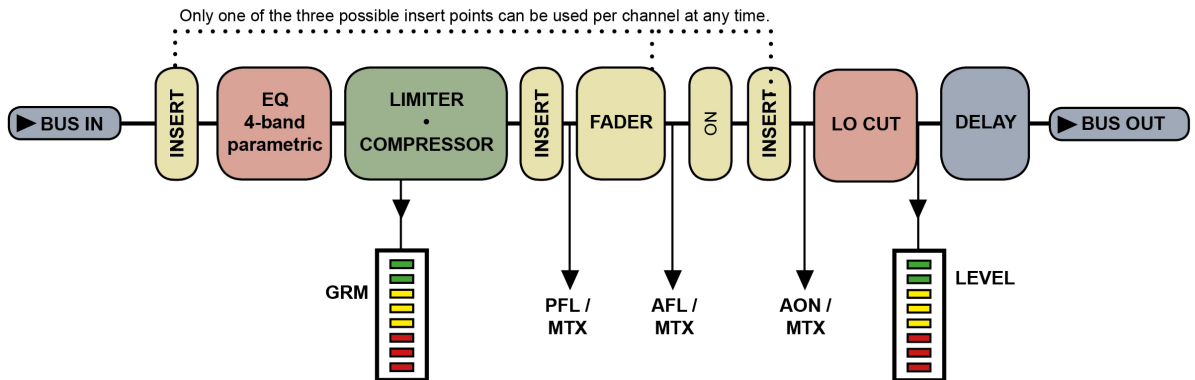

There are 24 configurable output busses on the Vi 3000, plus the Master Left, right, and Center (LRC) busses. You can choose to assign any of the 24 busses as mono OR stereo Auxilliaries or Groups with full processing. You can create stereo busses with no reduction in the total number of available busses (24 busses are available regardless of whether they are mono or stereo).

Up to 16 busses can be configured as mono or stereo Matrix (MTX) outputs with full processing, each with up to 24 configurable sources (including busses) - effectively creating up to 16 24-source mixes. Most of the references in this chapter refer to the Auxilliary and Group assignments. For the full Matrix system reference please see the Matrix reference chapter 9.

In normal operation (Output Fader Pages A, B, C, and User views) bus master output controls are mapped to the VST encoders in the Master Bay Vistonics screen over two pages. Use the [PAGE A] and [PAGE B] buttons to switch between those pages.

Output: LCR Mix Master Busses

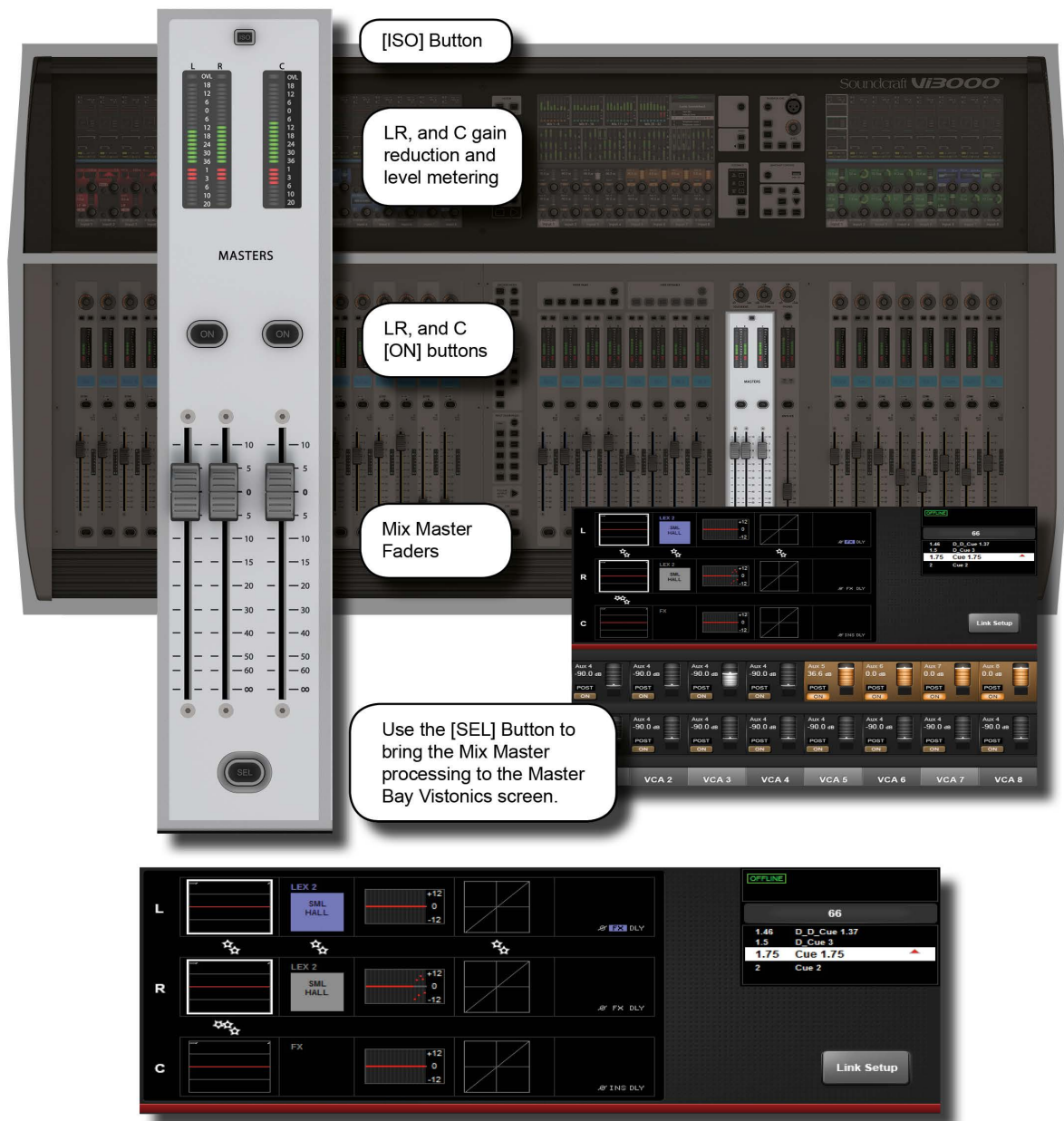

LRC Mix Outputs

The LRC Bus Master faders are located in the MASTERS section in the console Master Bay. These are dedicated faders and controls, and are never used for anything else.

To access the LRC Bus mastering page, simply press the MASTERS [SEL] button. The processing page will appear on the MasterBay Visonics touch screen area.

The LRC Master busses can have their Parametric and/or Graphic Equaliser sections linked for easier adjustment. See below for more detail.



Isolate

Active

	Isolate the LRC Masters from snapshot recall or Show Recall (with global filtering active).	See the Snapshots / Global Filtering reference for more detail.		Channel isolated
---	---	---	--	------------------

On

Inactive

Active

	Bus On/Off (Mute).		Off (Muted)	On
---	--------------------	--	-------------	----

LCR Select

Active0

	Access the LCR Master Busses processing page.	Gives access to the procesing blocks in the Master LRC outputs via the touch screen area of the Master Bay Vistonics.		GEQ In
--	---	---	--	--------

LCR Fader

	Control the output levels of the LRC Masters	The output levels of the LRC Master outputs are always controlled by their dedicated faders. Those faders are never used for anything else.		
---	--	---	--	--

L/C/R Link setup

	Set up LRC Master bus EQ and GEQ linking.	Left and Right busses can be linked, or the Centre bus can be added to the linked L and R so that all three busses can be adjusted together. It is not possible to link Left and Centre or Right and Centre. The default state, loaded with Default Show Files, is for LINK to be set to ON for LCR busses, both EQ and GEQ.		
---	---	--	--	--

Access EQ

	Adjust the parametric EQ for this Master.	The output bus parametric EQ is the same is used for the input channel EQ. Please see the input channel reference for more detail.		
---	---	--	--	--



**Access L/C/R
GEQ**

	<p>Maps the BSS Graphic equaliser for this block to the console faders.</p>	<p>See the BSS Graphics Equaliser reference later in this chapter for more Detail.</p>		
---	---	--	--	--

L/C/R Dynamics

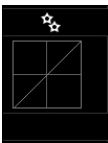
	<p>Access the L/C/R bus dynamics.</p>	<p>The controls are identical to those of the input channels, except there are no Gate or De-Esser modes available for output busses.</p>		
---	---------------------------------------	---	--	--

**L/C/R Insert/
Delay etc**

	<p>The controls for the Insert/Delay section are similar to those of the input channels.</p>	<p>Extra functions unique to the insert section of the output channels are Low Cut Filter, Phase, and Delay. However, these are the same as those in the Input section of the input channels.</p>		
--	--	---	--	--



Output: Bus Configuration



To configure the console busses and map the bus masters to the console input channel strips, you simply press the [ALL BUSS] button in the Input Fader Pages controls or assign a bank of eight bus masters to input bay 3 (right hand bay) by touching the relevant metering group in the Master Bay touch screen. You then patch physical outputs and name the busses by touching the Panning/Insert processing block in the touchscreen area and pressing the {BUS OUT} and {OUT LABEL} buttons in the VST area.

You can name the output busses and assign the physical output by touching the final PAN/INSERT/DELAY processing block and pressing the {BUS OUT} and {OUT LABEL} buttons in the VST area.



Bus Type

	<p>Set the Bus Type for this Bus.</p>	<p>Choose from AUX, GRP or MTX with the encoder. If Aux is selected and if the format field is set to stereo then the {CHPAN} field is enabled.</p>		
---	---------------------------------------	---	--	--

Pan Follows Channel

	<p>Set 'Pan follows channel' for a stereo bus.</p>	<p>Set this so the panning into a stereo auxilliary follows the channel panning rather than the Aux panning.</p>		
---	--	--	--	--

Bus Format

	<p>Choose a format (mono or stereo) for the bus.</p>	<p>For Stereo Auxilliary busses, the CHPAN option will become available.</p>		
--	--	--	--	--



Output: Bus Master Control

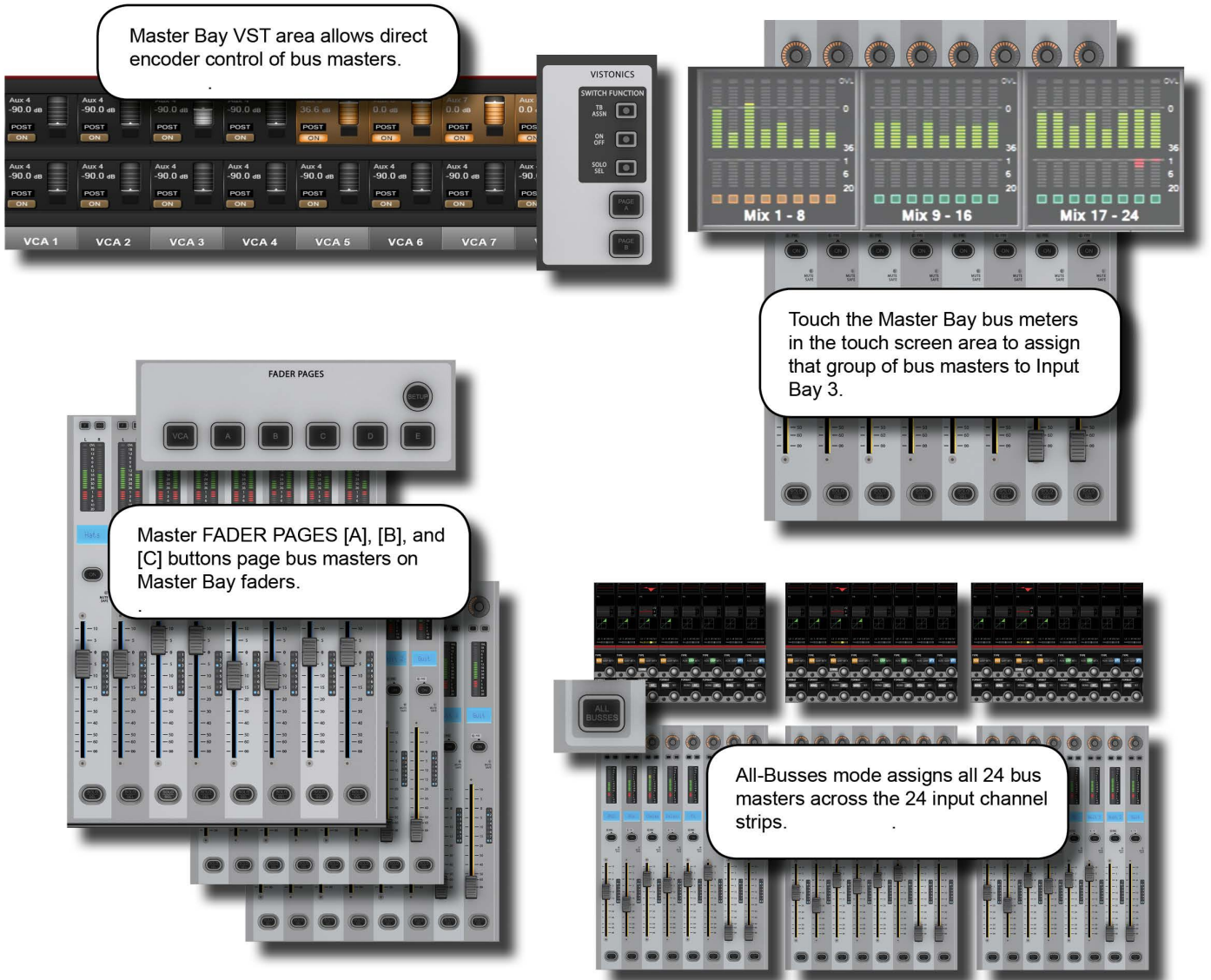

Outputs Controls

There are four ways of controlling the console's bus masters and two ways of accessing the output bus processing and parameters:

Master Bay VST Encoders

Bus master levels are available on the VST Encoders in the Master Bay, with groups of bus masters selected via the [Page A] and [Page B] Vistonics control buttons. The [TB ASN] (Talkback Assign), [ON/OFF], and [SOLO/SEL] Vistonics control buttons select the VST button function.



Master Bay output channel strips

Bus masters levels can be mapped to the eight Master Bay faders and associated channel strip controls by selecting Master Bay FADER PAGES buttons [A] (Busses 1-8), [B] (Busses 9-16), and [C] (Busses 17-24).

All Busses Mode

If the All Busses mode is active, achieved by pressing the [ALL BUSS] button in the Master Bay INPUT FADER PAGES controls, the input strips on all of the input bays will be switched to control the 24 output busses and the faders will control the bus master output levels.

Third Input Bay - Fast-Select

By touching any of the channel metering areas in the Master Bay touch screen area you assign that bank of eight to the third input bay. Three banks of eight outputs are located on the top row on the Master Bay touch screen.

Bus Parameter Control

With the console in All Busses mode, the console's Vistonics screens give direct touch access to the processing chains of all 24 output buss channel strips.

Alternatively, with the Master Bay Vistonics button function set to [SOLO/SEL], pushing any bus master channel strip [SOLO/SEL] button will display that bus output's processing chain in the Master Bay touch screen area.

In both cases, selecting a processing block will bring that block's parameters up on the VST area of the Vistonics screen.

Output: Master Bay Vistonics

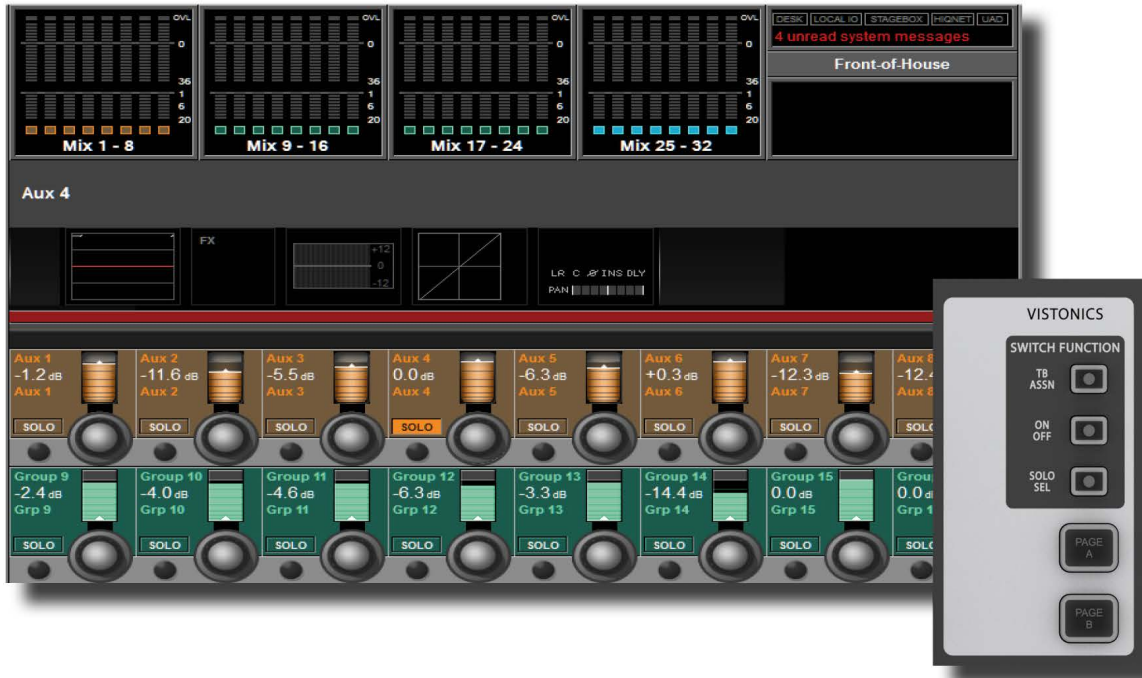

With the Bus Master Controls in the VST fields of the Master Bay, a number of primary functions are available. Use the Master Bay VISTONICS button group to control which functions and which masters are available.

Talkback Assign Mode

	<p>Assign the {TB ASSN} function to the bus masters VST buttons.</p>	<p>See the Talkback and Oscillator chapter for more information.</p>		
---	--	--	--	--

On/Off Mode

	<p>Assign the {ON} function to the bus masters VST buttons.</p>			
---	---	--	--	--

Solo/Sel Mode

	<p>Enable solo/Select Mode</p>	<p>Assigns the {SOLO} function to the bus masters VST buttons and let the Bus channel strip [SOLO/SEL] buttons access the bus parameters via the Master Bay touch screen.</p>		
---	--------------------------------	---	--	--



Masters Bank Pages

	<p>Switch between banks of bus masters in the Master Bay Vistonics VST area.</p>			
---	--	--	--	--

Bus Level

	<p>Control the level of the bus output.</p>			
---	---	--	--	--

Bus Solo

	<p>Solo this bus output.</p>	<p>See the Solo system chapter for more information.</p>		
--	------------------------------	--	--	--

Bus ON

	<p>Enable / Disable (Mute) this Bus</p>			
---	---	--	--	--

Talkback Assign

	<p>Assign this bus to the Talkback system.</p>	<p>See the Talkback and Oscillator chapter for more information.</p>		
---	--	--	--	--

Output: Master Channel Strip

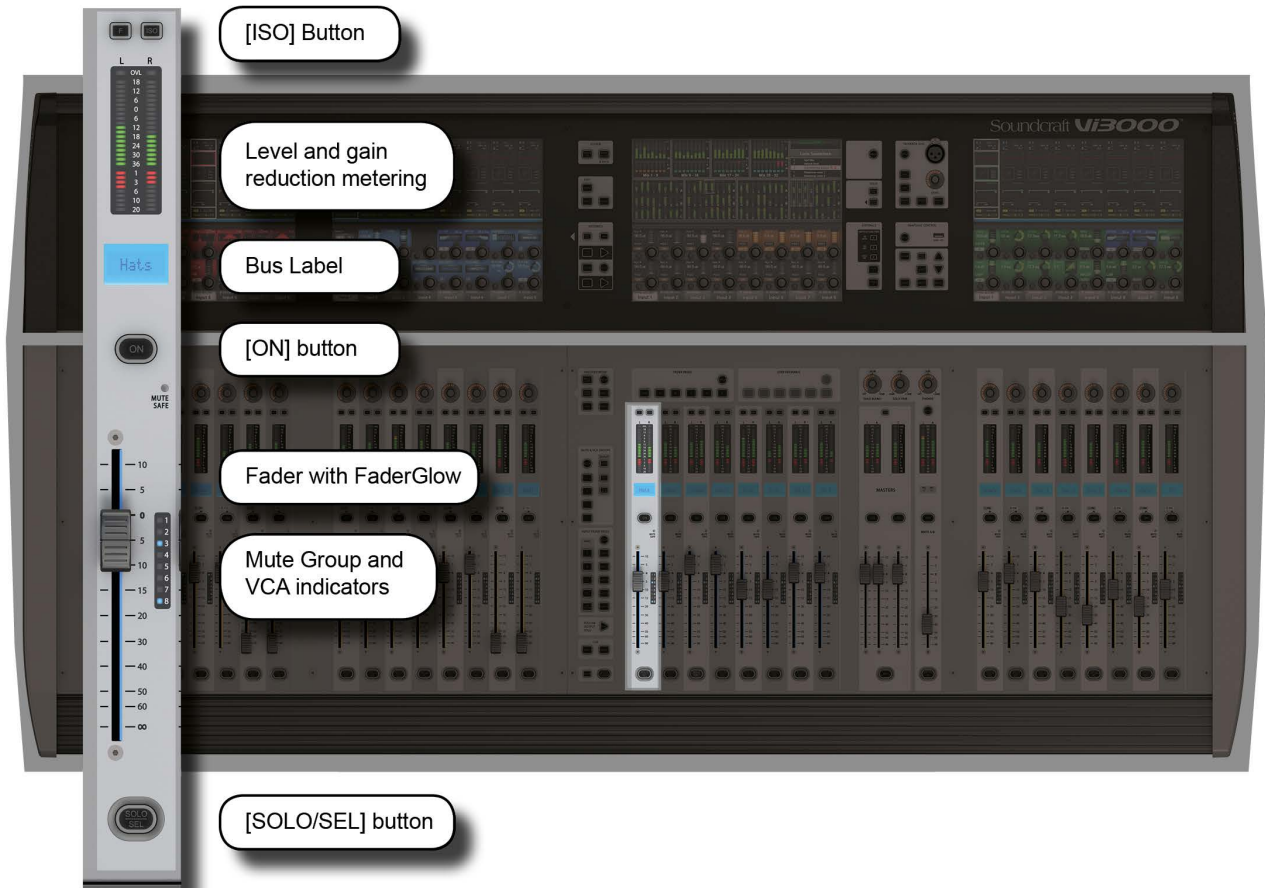

The MasterBay channel strips are for output Bus and VCA control, determined by the Master Bay Fader Pages selectors. The [VCA] button maps VCA masters 1-8 to the Master bay faders. Buttons [A] through [C] map busses 1-24 to the Master Bay channel strips in groups of eight. Buttons [D] maps VCA masters 9-16 to the eight master bay faders. For more information on VCAs, please see the Mute Groups & VCAs reference section 9. However, using the [ALL-BUSSES] mode and Master Bay meter selection input channel strips become bus master strips.

ISO: Isolate Bus

	Isolate this bus from snapshot recall and Show recall (when Global Filtering is active)	See the Snapshot and Global Filtering chapter for more information.		
---	---	---	--	--

Mute Safe LED

	Indicate when Mute Safe is active for this bus.	When the Mute Safe system is enabled (in Monitoring section [SETUP]), then the channel strip SOLO/SEL button activates the Mute Safe status for that channel.		
---	---	---	--	--

Bus Fader

	Control the the bus master output level.			
--	--	--	--	--

FaderGlow

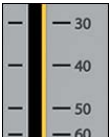
	The channel fader is colour-coded depending on its function.	Input channel levels are not colour-coded. The other FaderGlow colours are Aux Sends: ORANGE; Groups: GREEN; Matrix Contribution: CYAN; VCA Master 1-8: BLUE; VCA Master 9-16: PINK.		
---	--	--	--	--

Bus MUTE/VCA Display

	Shows mute group and VCA group assignment for this channel.			
---	---	--	--	--

Bus SOLO/SEL

	Defaults to adding the a SOLO enable for the channel.	If a touch-panel screen is open for the for another channel in the same bay, the [SOLO/SEL] button moves the touch screen to this channel. The button has other functions in other console modes such as selecting channel for a Copy or Paste edit function. Other functions for the [SOLO/SEL] button are detailed in the appropriate reference sections.		
---	---	---	--	--

Output: Master Bus Processing Chain

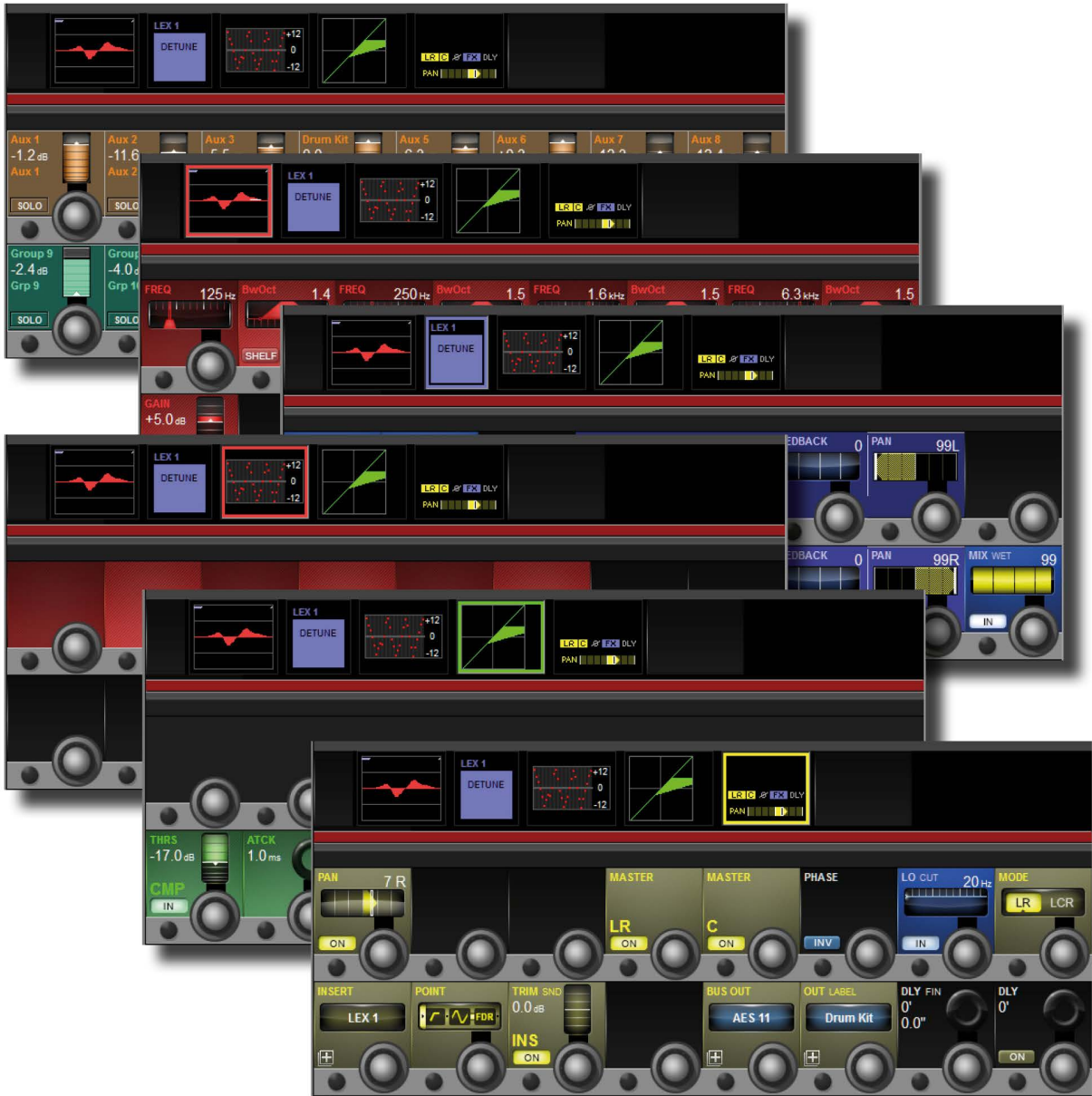

The bus output processing chain has a parametric EQ block, a BSS Graphic Equaliser block (GEQ), a dynamics block, and a Pan/Insert block. You can also label the bus, assign a physical output, and set a delay inside the Pan/Insert block.

Bus Channel Strip EQ

	<p>Adjust the parametric EQ for this Master.</p>	<p>The output bus parametric EQ is the same as used for the input channel EQ. Please see the input channel reference for more detail.</p>		
---	--	---	--	--

Bus Channel Strip GEQ

	<p>Maps the BSS Graphic equaliser for this block to the console faders.</p>	<p>See the BSS Graphics Equaliser reference later in this chapter for more Detail.</p>		
---	---	--	--	--

Bus Channel Strip Dynamics

	<p>The controls are identical to those of the input channels, except there are no Gate or De-Esser modes available for output busses.</p>			
--	---	--	--	--

Bus Channel Strip Insert, Delay

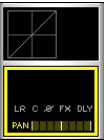
	<p>The controls for the insert section are similar to those of the input channels.</p>	<p>Patch and name the buss, as well as control panning insert configuration, delay, and more. Extra functions unique to the insert section of the output channels are Low Cut Filter, Phase, and Delay. However, these are the same as those in the Input section of the input channels.</p>		
---	--	--	--	--



Graphic Equalisers (GEQ)

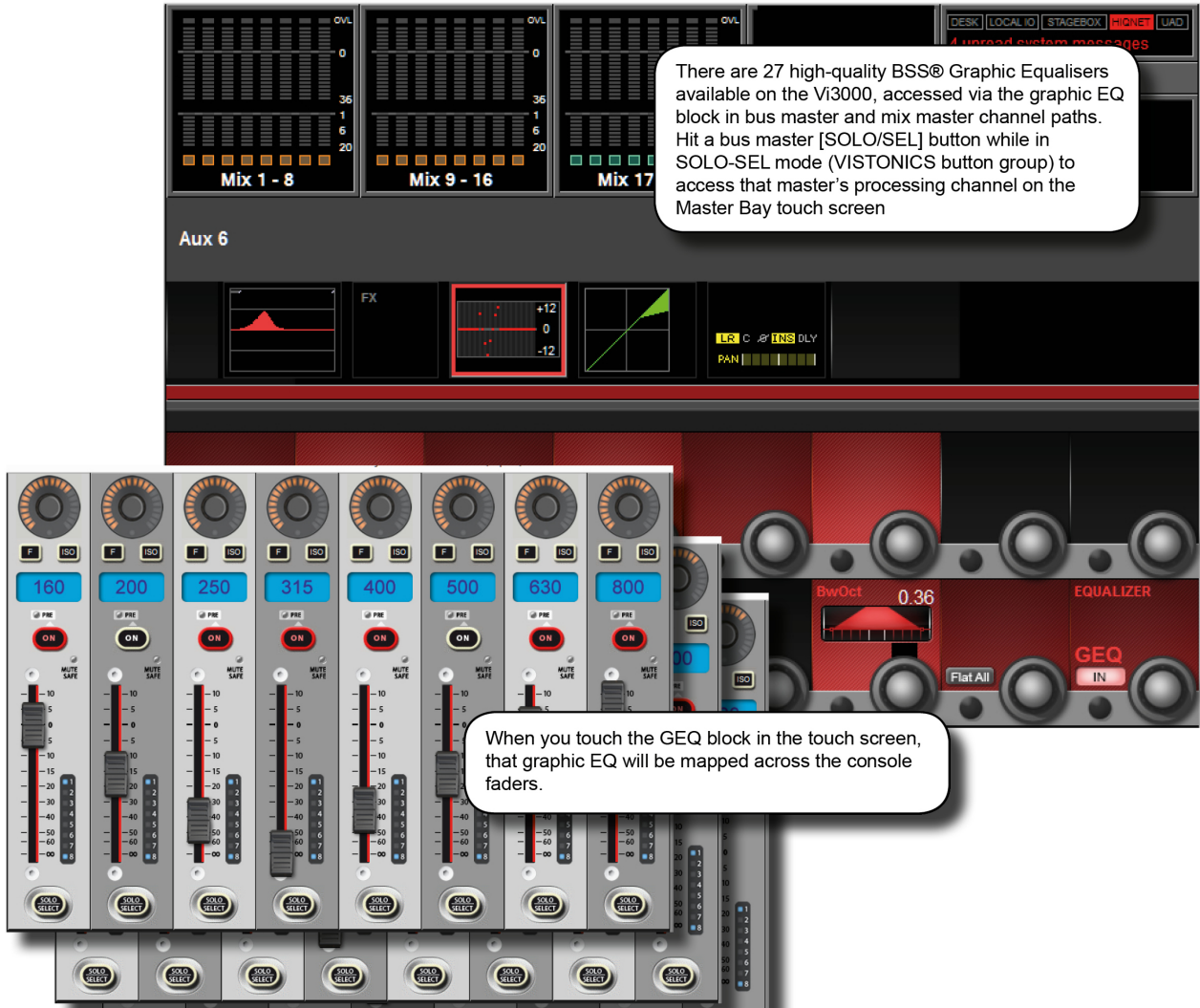

There are 27 high-quality BSS® Graphic Equalisers available on the V3000, accessed via the graphic EQ block in bus master and mix master channel paths. Hit a bus master [SOLO/SEL] button while in SOLO-SEL mode (VISTONICS button group) to access that master's processing channel on the Master Bay touch screen

When you touch the GEQ block in the touch screen, that graphic EQ will be mapped across the console faders.

The console has a total of 27 high-quality BSS Graphic Equalisers (GEQ) - one for each of the 24 assignable Busses, and one for each of the LCR Master outputs. The GEQs are all 30-Band EQs with an adjustable bandwidth control.

To access a GEQ, simply select a GEQ processing block from an output's touch-screen parameter display.

Bus parameter displays can be accessed either by entering All Busses mode with the [ALLBUSS] button and selecting the GEQ block from the corresponding channel's touch screen area, or by selecting a bus [SOLO/SEL] button while the Master Bay Vistonics button assign is set to Solo/Select. For more information see the Bus Output reference.

When a GEQ is selected, Bandwidth, Flatten, and In controls are mapped to the right-most VST controls, and the Graphic EQ bands are mapped to the console faders. There are two GEQ control modes. The Large GEQ mode maps all 30 bands across the consoles faders. The Small GEQ mode mode maps eight GEQ bands to the Master Bay faders - scrollable with the Output Fader Page buttons [A] to [E]. The GEW Control mode is set in the Main Menu Settings Tab.



Bandwidth

Range Low

Range High

	<p>Adjust the bandwidth of the 30 GEQ bands.</p>	<p>The Bandwidth units can either be Q or Octaves, depending on the {EQ UNIT} setting in the Main Menu (Settings Tab).</p>	<p>0.24Oct</p>	<p>0.36Oct</p>
---	--	--	----------------	----------------

Flatten All

Active

	<p>Flatten levels of all bands of the currently active GEQ to 0dB.</p>			<p>All GEQ bands 0dB</p>
---	--	--	--	--------------------------

GEQ In

Inactive

Active

	<p>Activate or deactivate the currently selected GEQ.</p>		<p>GEQ Out</p>	<p>GEQ In</p>
--	---	--	----------------	---------------

Graphic EQ Fader

Range Low

Range High

	<p>Adjust the level of the corresponding band.</p>	<p>The FaderGlow colour for a GEQ band is red. The centre frequency of the band is shown in the channel label display.</p>	<p>-12dB</p>	<p>+12dB</p>
---	--	--	--------------	--------------

GEQ Fader On Button

Active

	<p>Indicates which GEQ bands are non-zero, and flattens bands.</p>	<p>When you adjust the level of a GEQ band, the corresponding [ON] button is highlighted in red. A subsequent press of the [ON] button will flatten/null the band and turn the [ON] light off.</p>		<p>Band level 0dB</p>
---	--	--	--	-----------------------



Monitoring Matrix

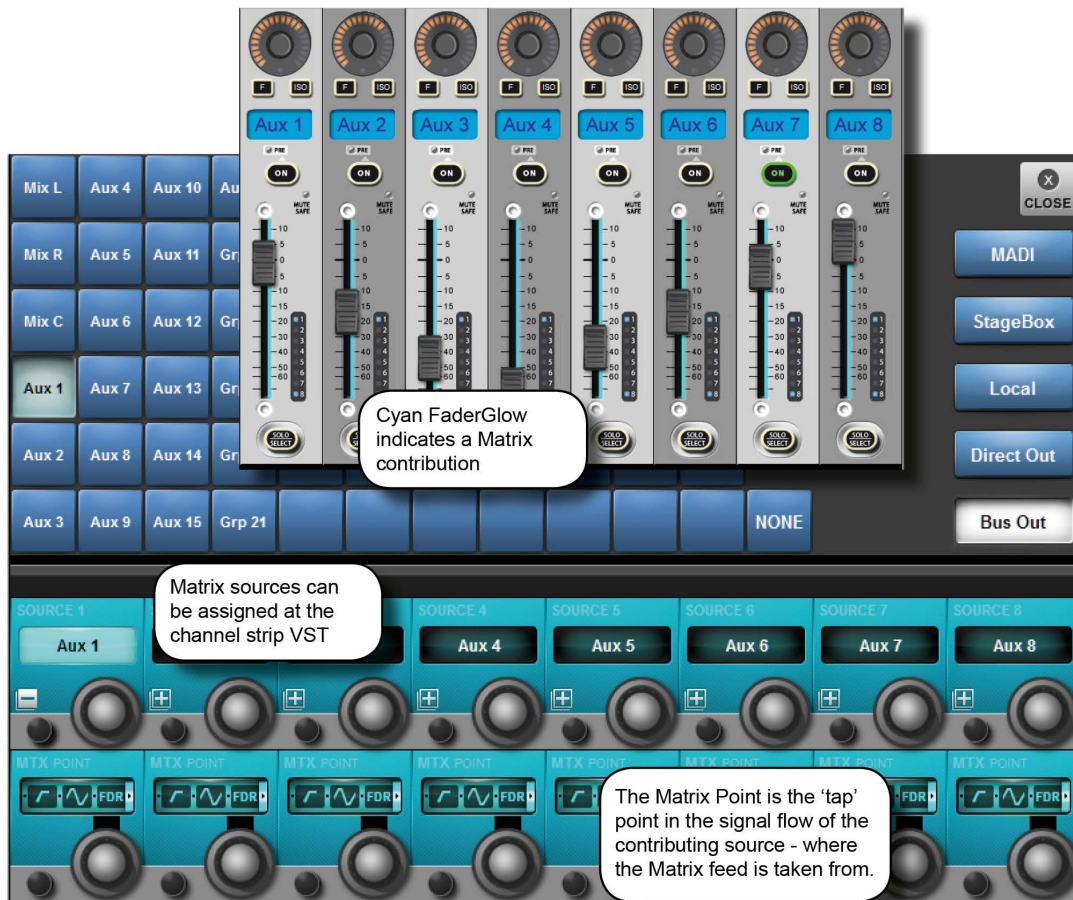

Instead of a simple Output matrix, the console has a built-in, freely-configurable matrix that can have up to 16 Outputs (mono or stereo) with full processing including parametric EQ, dynamics, delay, and graphic EQ. Each matrix output is a mix of up to 24 configurable sources that can be signals from busses, channel direct outputs, or inputs directly from the patching system.

The sources for each matrix mix can be individually patched, so the matrix can be utilized as 16 different mixers, each with up to 24 inputs, with output processing.

In order to use a matrix, the output bus must first be configured as a matrix output. This can be done easily either via All-Busses Mode (press the [All BUSSES] button in the Input Fader Pages section) or by touching the relevant meter group in the Master Bay touch screen. In this case, the buss masters and assignments will be mapped to the right-hand input bay.

Matrix Control

To map matrix contributions to the input bays, first ensure that the [ALL BUSSES] key is NOT selected, then Press the [SOLO/SEL] on a matrix master. All the input bays will change to the matrix contributions view and Faderglow™ illuminates with the matrix colour (cyan).

Press the Matrix source '+' Viconics button in one of the input screens above the fader you wish to use for the source. This opens a patching screen that allows the source to be chosen from the categories on the right side of the screen: MADI, Stagebox, Local, Direct Out or Bus Out.

Once the source is selected, its level to the matrix bus out will be controlled by the channel fader and [ON] button. With some types of source (Direct and Bus Out) it is possible to choose the point in the signal path of the source channel or bus from where the feed to the Matrix bus will be taken.



**Matrix Source
ON**

	<p>Turn on (or off) the corresponding matrix source.</p>			
---	--	--	--	--

**Matrix Source
Fader**

	<p>Adjust the level of this source as a contribution to the matrix mix.</p>			
---	---	--	--	--

**Matrix Source
Solo/Sel**

	<p>Cancels the Matrix mapping and returns channels to normal operations.</p>			
--	--	--	--	--

**Matrix Pan En-
coder**

	<p>Pan control for stereo Matrix sources.</p>	<p>If the Matrix bus is stereo, the Pan control will appear above each Matrix Source fader allowing the selected source to be positioned within the stereo image of the Matrix bus. If the Matrix is mono, this control will have no function.</p>		
---	---	--	--	--

**Matrix Source
Source**

	<p>Choose a source for this matrix input.</p>	<p>The button opens up a patch selection screen with all available matrix sources, including output busses, physical console inputs, and input channel direct outs.</p>		
---	---	---	--	--

Matrix X Point

	<p>Select the point/tap where the selected matrix source is taken from. For example, selecting a buss master as a matrix source offers the choice of pre-fade, post-fader, or post-ON.</p>			
---	--	--	--	--



Mute & VCA Groups

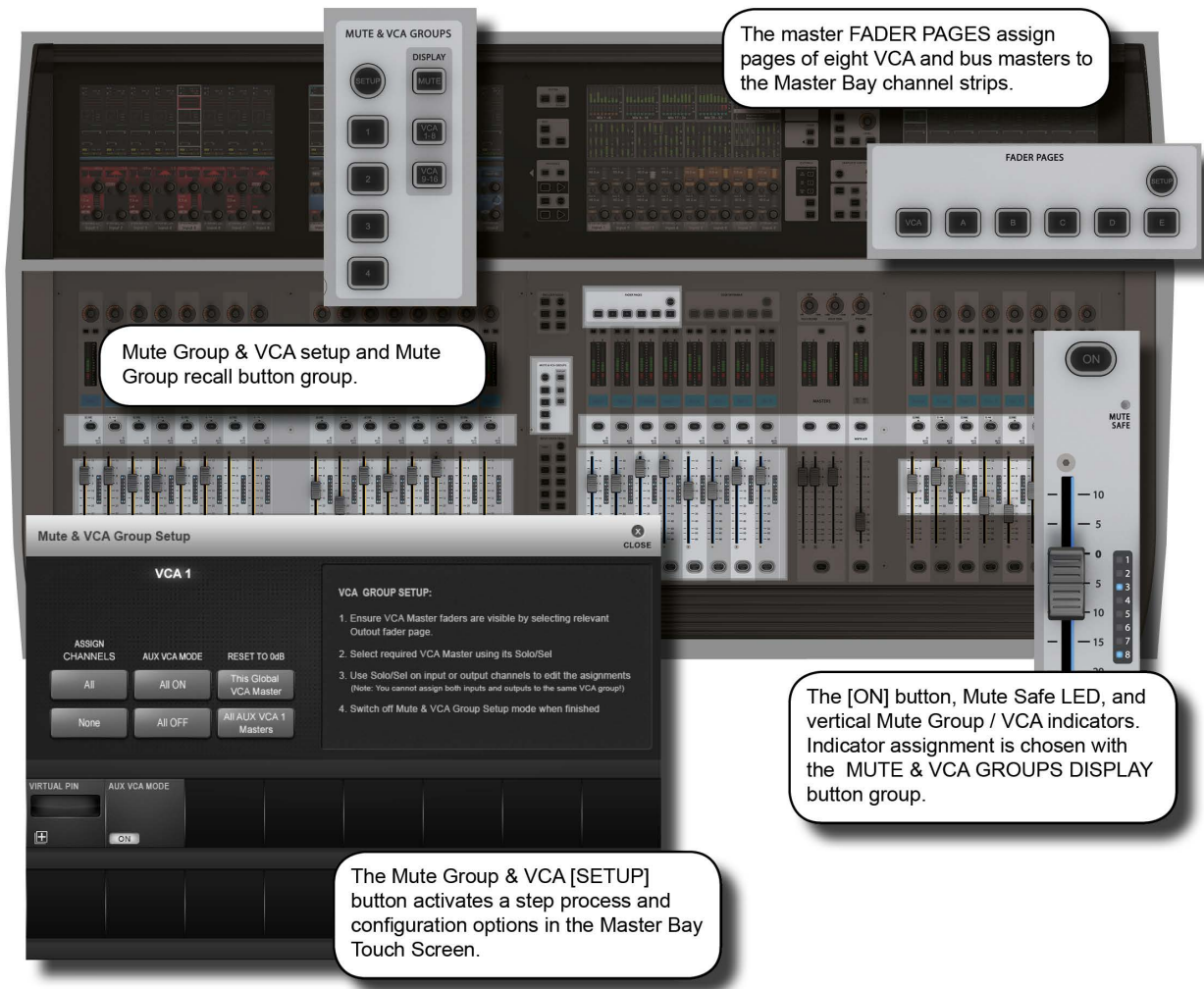

The console supports up to 4 mute Groups (MG) and 16 primary VCA masters that can include both input and output channels.

There is a secondary level of VCA functionality, most useful for monitor engineers, which allows the user to assign up to 16 VCA masters to each auxiliary mix when the auxiliaries are controlled for the channel faders. This means there are 25 possible sets of 16 VCA groups. A more detailed reference for this functionality is included later in the this chapter (section 9.3).

Each input and output strip has a VCA/mute group display next to its fader made up of eight LED indicators. These show which mute and VCA groups each channel belongs to in three modes: mute groups 1-4, VCAs 1-8, and VCAs 9-16. The mode selection for the indicators is selected in the DISPLAY section of the MUTE & VCA GROUPS buttons located on the left side of the Master Bay fader panel.

Mute Groups Operation



There are four console mute groups, activated with the [1], [2], [3], and [4] buttons in the MUTE & VCA GROUPS button group. Both input and output channels can be assigned to mute groups.

When a channel mute is activated by a mute group, the channel's ON button glows red.

Mute group assignment is started by pressing the MUTE & VCA GROUPS [SETUP] button (see below).

Mute Setup

			Inactive	Active
	Press the MUTE & VCA GROUPS [SETUP] button, then chose a Mute Group button to configure that group.	The [SETUP] button will glow blue when pressed. The chosen mute group master button - [1], [2], [3], or [4] - will glow red when you select that group. Press the [SOLO/SEL] key of any channels (input and/or outputs) to be assigned to the selected mute group, then press [SETUP] again to exit the configuration mode.	Normal	Mute Setup Mode

Mute Group 'n'

			Inactive	Active
	Press to activate / select a Mute Group.	In normal use, the mute groups selectors will activate the chosen mute group (mute those channels). In setup mode they select a mute group to be set up.	Normal	Mute Group Selected

VCA Group Operation

VCA Groups configuration is started by pressing the MUTE & VCA GROUPS [SETUP] button. When you press a VCA Master [SOLO/SEL] button you can assign channels to that VCA group with their individual [SOLO/SEL] buttons, and also access VCA group options - including labelling - in the Master Bay Visonics. See below for more information.

You can select EITHER output channels OR input channels to be part of a normal VCA group.

In order to assign VCAs, the VCA masters [SOLO/SEL] buttons have to be made available by selecting the appropriate Master Bay Fader Pages layer - [VCA] for VCA masters 1-8, or [E] for VCA masters 9-16.

VCA Master level at setup

The assignment of VCAs should be done with the channel or group faders and the VCA master, to which assignment is being made, being at or near a nominal operating level. That is, don't assign a VCA master to a channel or group if the VCA master is at -40dB while the channel or group is at 0dB. There are 0dB buttons for VCA masters available in VCA group configuration mode.

VCA and 'E' Buttons

			Inactive	Active
	Fader Pages buttons for mapping VCAs to the Master Bay faders.	The [VCA] button maps VCA masters 1-8 to the eight Master Bay faders. The [E] button maps VCA masters 9-16 to the eight Master Bay faders. VCA Masters 1-16 can be assigned to any Output Fader page from A to E, along with Bus Output faders using the User Defined fader page setup. The VCA page cannot be remapped and always contains VCA 1-8.		Select VCA Range

VCA Masters [ON] Buttons

			Inactive	Active
	Master On/Off button for all of the VCA's member channels.	If a channel that was previously on is turned off by the action of a VCA Master [ON]/Off button, the channel's [ON] button will illuminate in red to distinguish this condition from a manually 'off' channel. The VCA Master On/Off switch itself has only 2 states, and always illuminates red when off, and green when on.	All VCA Members OFF (muted)	All VCA Members ON

VCA Group Fader

			Inactive	Active
	An offset dB level for all channels that are members of the VCA Group.	<ul style="list-style-type: none"> When a VCA master fader is moved, the contributing channel fader levels remain unchanged. If a channel is assigned to more than one VCA Group, the resultant offset applied to the channel is calculated as the arithmetic sum of the dB values of each VCA Master. Any VCA master fader reaching -infinity dB (fader at lowest position) will set all member channels to -infinity dB, regardless of other Master fader settings. The maximum gain applied to a member channel as the result of the channel fader setting plus offsets from VCA Master faders is limited to +10dB. 		-infinity

VCA Master Solo/Sel

			Inactive	Active
	A master Solo button for all of the VCA's member channels.	Depending on the setting of the AUTO button in the Monitor Setup page (SOLO section), activating a VCA Solo will result in PFL (if the group only has one member channel) or AFL (if the group has more than one member channel). Otherwise the VCA solo will follow the setting of the PFL/AFL switch in the Monitor Setup page.	Normal	Soloed



VCA Setup

Inactive

Active

	<p>Press the MUTE & VCA GROUPS [SETUP] button, then chose a VCA [SOLO/SEL] to configure that VCA group.</p>	<p>The [SETUP] button will glow blue when pressed. The [SOLO/SEL] button of the chosen VCA Master will also glow blue. You can then press the [SOLO/SEL] buttons on any channels you wish to make part of that VCA group. Then either press the [SETUP] button again to exit the configuration mode, or press another VCA Master [SOLO/SEL] button to configure a new VCA group. During configuration of VCA groups, a number of options become available in the Master Bay touch screen and VST area (see below).</p>	<p>Normal</p>	<p>Setup Mode</p>
---	---	--	---------------	-------------------

Bulk Assign VCA

	<p>Select all input channels or no channels as members of the VCA Group.</p>	<p>Select the VCA Group you require by pressing its [SOLO/Sel] button first.</p>		
---	--	--	--	--

Aux VCA Mode Bulk On/Off

	<p>Switch all VCA Masters in the Master bay between Aux VCA Mode and Normal mode. (See Aux VCA Mode reference).</p>			
---	---	--	--	--

Reset VCA Masters

	<p>Set VCA Masters to 0dB.</p>	<p>Either set the currently selected master to 0dB, or all aux send VCA masters (see Aux VCA Mode reference).</p>		
---	--------------------------------	---	--	--

Label VCA Group

	<p>Opens up a standard labelling keyboard in the Master Bay touch screen area for labelling the VCA master.</p>		<p>Hide Labelling Keyboard</p>	<p>Show Labelling Keyboard</p>
---	---	--	--------------------------------	--------------------------------

Aux VCA Mode [On]/Off

	<p>See the currently selected Aux VCA Master on or off (see Aux VCA Mode reference).</p>	<p>When in fader [FLW] mode and an Aux master is selected, VCA Masters set to 'ON' will control the Aux VCA group, not the 'normal VCA group. Aux VCA group master faders are highlighted with white FaderGlow, while 'normal' channel VCAs are highlighted with blue FaderGlow.</p>	<p>Normal</p>	<p>Aux VCA Mode Active</p>
---	--	--	---------------	----------------------------



Aux VCA Groups (fader controlled)

Channel 1's input fader is assigned to VCA 1; input channels' 3, 4, and 5 faders are assigned to VCA 4.

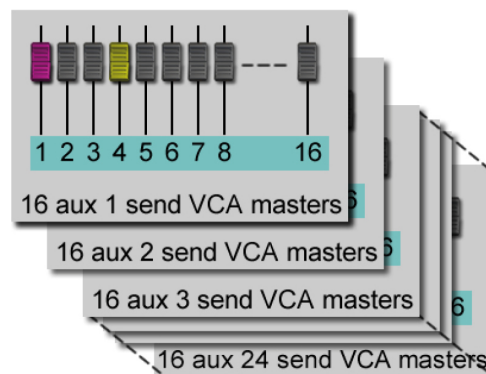
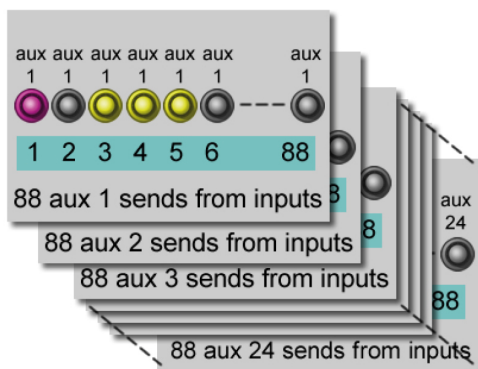
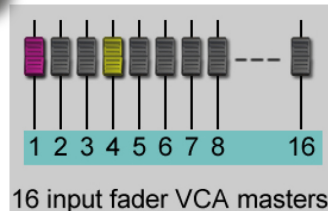
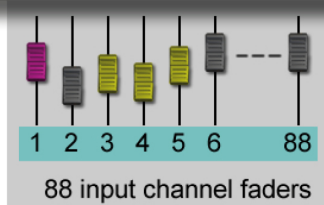

There are up to 24 sets of 16 aux send VCA masters (corresponding to 24 available aux sends). Assignments mirror the channel fader VCA assignments.

The VCA Groups on the console are normally used to control groups of the input channel faders, for use by FOH engineers. In this case they are used to group mono and/or stereo channels together under control of a single master fader, for easier control during a mix.

For the Monitor mix engineer, controlling channel faders is of secondary importance to controlling Aux sends from channels, and so the functionality of VCA Groups has been extended to control of groups of Aux sends as well as channel faders.

Because there can be up to 24 Auxiliary sends configured on the console, this means that there are up to 24 sets of VCA groups (each with up to 16 Group Masters), in addition to the set of main channel fader VCA groups.

VCA control of Auxes is only available by activating the Follow Output Solo [FLW] key next to the master faders. The pair of [FLW] keys for the VST Encoder Rows will not access this function.

It is possible to control only one Aux mix via its VCA masters at any one time.

When setting up Auxiliary VCAs, it is possible to turn the Aux VCA masters mode on or off for each VCA Master, so 'normal' VCAs can still be available.



Auxilliary VCA Procedure

- 1) Select the Aux bus required by selecting the required master fader page [A]-[C].
- 2) Activate the [FLW] key next to the master faders.
- 3) Press the [SOLO/SEL] key under the required Aux master fader (or use the solo switches in the Master VST area).
- 4) Press [VCA] (for VCA 1-8) or [E](for VCA 9-16).
- 5) The FaderGlow for any active VCA master faders will change to white and the faders will move to show the offsets being applied to the Aux feeds from those channels assigned to the VCAs. At this point, the VCA Master [SOLO/SEL] keys have no function. The VCA [ON] switch controls the Aux send On/Off on the member channels.
- 6) To select another Aux for adjustment, press the required bank key [A]-[C], solo the required aux (or solo directly on the VST screen), and press [VCA] or [E]. To exit, press [SOLO CLEAR] and de-select [FLW].

Note: To set up Auxilliary VCAs, press the MUTE & VCA GROUP [SETUP] button after step 4 and assign member channels to that Aux VCA group as per the normal VCA group setup procedure (use the channel [SOLO/SEL] buttons to choose members, then press [SETUP] to exit). Note that Aux VCA Groups have to share the same input assignments as the 'normal' channel VCAs.

Monitoring System

There are three main monitoring outputs - A, B, and headphones. You can select a variety of sources for the monitoring outputs, including two user-definable sources (USER A, USER B) with separate left and right assignments.



The monitoring system has three main sources - Monitor A, Monitor B, and Headphones. These are fed by a choice of sub-sources, including Solos, LCR, Talkback return, and two user-defined stereo sources where the left and right signals can be patched independently



Monitoring input source options

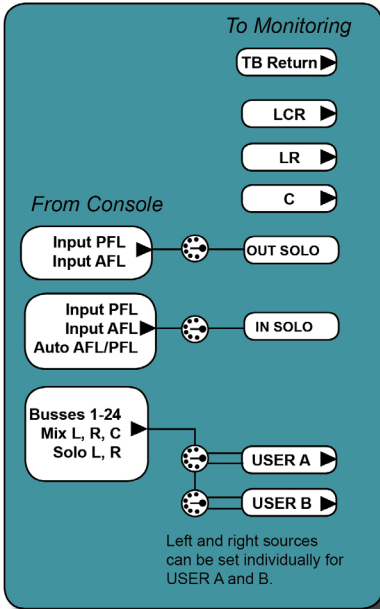

The input and output solo, and User A and User B monitor sources have their own patching options, available through the Monitoring SETUP screen.

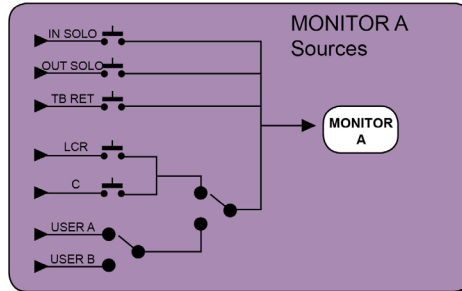

Depending on the MONITOR A, MONITOR B, and HEADPHONE (HP) source type, LCR or LR can be combined with C, though this feed and the USER A/B selection are exclusive. That is, you can choose LCR or LR and C, or USER A or USER B. Solo and Talkback return feeds can be combined with all sources.

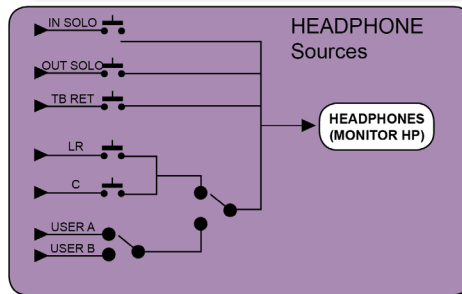
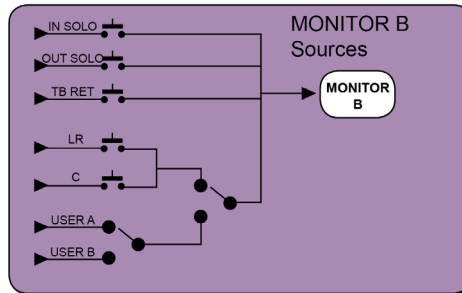

Monitoring: Console Controls

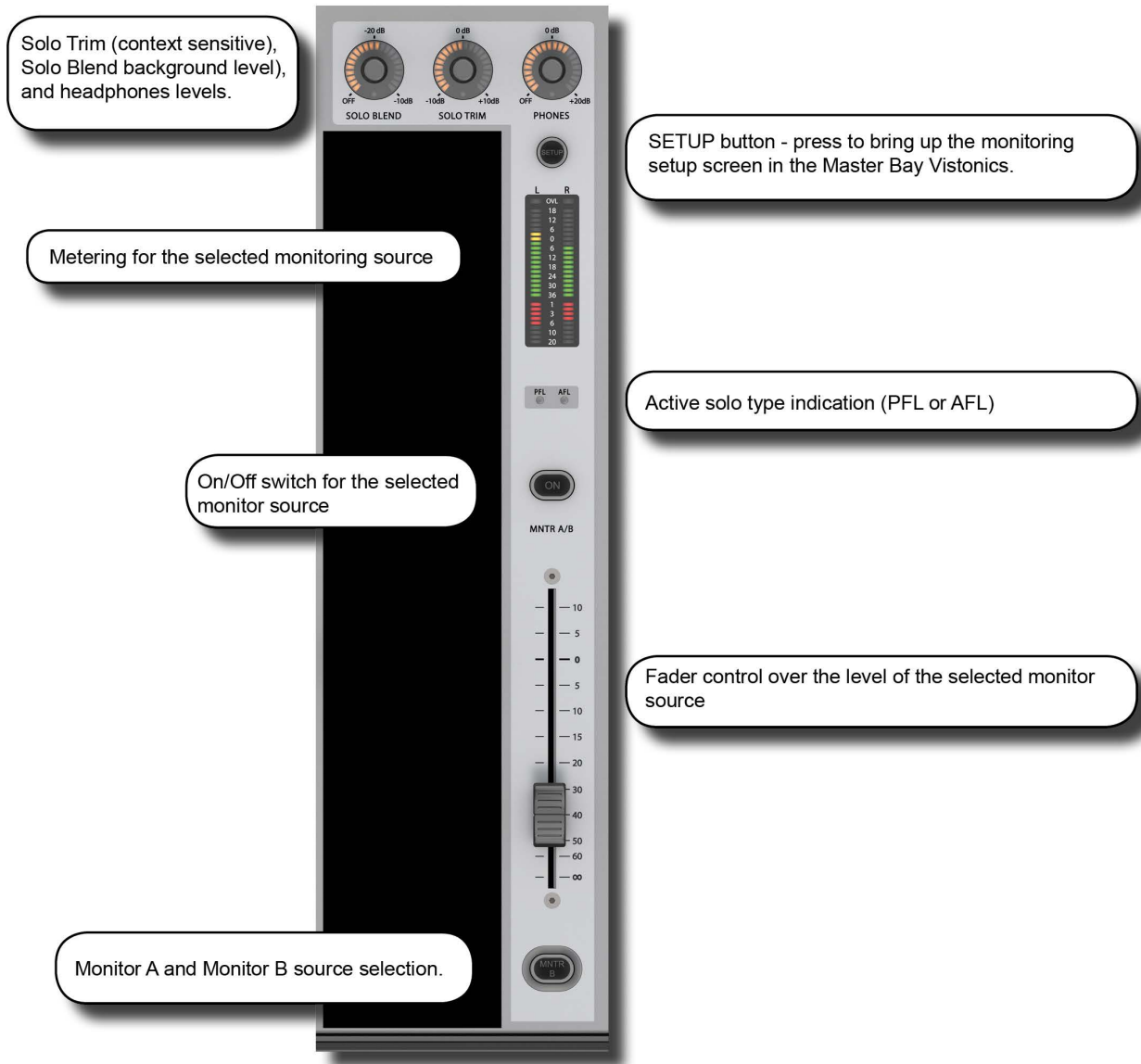

The following console monitoring controls are located to the right of the master faders in the Master Bay, except for [INPUT PRI] (Solo Input Priority), which is located with the SOLO button group on the upper section, to the right of the Master Bay.

There are three main monitoring outputs - A, B, and headphones. Monitor A is an LCR output, Monitor B is an LR output, and the headphones output is LR to the headphone socket on the front of the console. You can select a variety of sources for the monitoring outputs, including two user-definable sources, USER A and USER B, with separate left and right assignments.

Solos can be blended with the main monitor feed for contextual solos, and an Auto function can be set to select PFL or AFL depending on your solo selections.

Solo system control is described in the Monitoring SETUP section. The console's Solo system logic and general use is described in the next chapter (11).



MNTR B - Monitor A/B Select

		Inactive	Active
	Select either the A or the B monitor to be displayed on the meter, to be controlled by the fader, and to be switched on and off by the [ON] switch.	Both Monitor A and B sources are always active - (respecting their individual On/Off status'). The MTR B button changes metering and control assignment.	Monitor A Monitor B

Monitor Fader

		Range Low	Range High
	Control monitoring volume level.	-Infinty	+10dB

AFL and PFL indication

	These two LEDs show if an active solo is a PFL or an AFL.		
--	---	--	--

Monitoring Setup

		Active
	Display the Monitor Set-up Page on the master screen.	The [SETUP] key glows blue when it is active. SETUP Active

Headphones Level

		Range Low	Range High
	Control the headphones volume level.	The headphone output socket is located under the arm-rest at the front of the console, and is designed for headphones with impedances in the range 50-600 Ohms.	OFF +20dB

Solo Trim

		Range Low	Range High
	Trims source SOLO Level.	This control is SOLO context sensitive. It is possible to set a different trim for each of the 24 outputs in addition to a global input solo trim level.	-10dB +10dB



Solo Blend

Range Low

Range High

monitor_con_solo-Blend.jpg	Adjust the background level of the monitoring source signal.	The level of the non-solo source adjusted from OFF to -10dB to allow solos to be heard in the context of a mix that has a reduced level.	OFF	-10dB
----------------------------	--	--	-----	-------

Solo Input Priority

Active

monitor_con_soloIn-Priority.jpg	Activate Input Priority Mode	Allows an Output Solo to remain active, whilst an Input Solo is temporarily activated 'over the top' of it. When the Input Solo is deactivated, the Output Solo's audio will return to the Solo Bus. For more detail, see the Solo System reference chapter 11.		Input Priority Active
---------------------------------	------------------------------	---	--	-----------------------



Monitoring Setup



All monitoring source assignments for MONITOR A, B, and HP are assigned in the monitoring setup page, as well as monitoring delay.

Monitoring Input Solo Source

	<p>Choose either input channel PFL, AFL, or 'AUTO' as the Input Solo source.</p>	<p>The AUTO option works by selecting PFL when only one solo is active and AFL when more than one solo is active.</p>		
---	--	---	--	--

Output solo source

	<p>Choose either output buss PFL or AFL as the Output Solo Source.</p>			
---	--	--	--	--



Solo-In-Place Mode

	<p>Activate the SOLO-IN-PLACE mode.</p>	<p>This is a destructive mode for use only during sound-checks or rehearsals. When a channel is soloed in SIP mode, all other channels are muted so that only the soloed channel is heard, in its stereo position, at the console's mix outputs.</p>		
---	---	--	--	--

Mute Safe Mode

	<p>Enable the Mute Safe (SIP isolation) configuration mode.</p>	<p>If (MUTE SAFE) is active the Mute safe state from the Input channels can be toggled with the Channel's SEL Key. The state for a given channel is indicated by that channel's Mute Safe LED. NOTE: This configuration mode is disabled when the setup page is exited.</p>		
---	---	---	--	--

MON SETUP Mode

	<p>Activate the Monitor Setup sub-page.</p>	<p>The Monitor Setup sub-page parameters become available in the VST area of the master screen. See below for more details.</p>		
--	---	---	--	--

Auto Cancel Mode

	<p>TBC</p>			
---	------------	--	--	--

LCR Source Select

	<p>Select the mix master output sources for the monitor outputs A, B, and HP</p>	<p>For the Monitor A (LCR) output you can choose LCR and/or C; for the Monitor B and Headphone outputs you can choose LR and/or C. This selection cannot be combined with the User A or User B sources, but solo and talkback options are concurrent.</p>		
---	--	---	--	--

User A / B Source Select

	<p>Select the user-defined output source for the monitor outputs A, B and HP.</p>	<p>Choose EITHER User A or User B as a main source for the monitoring output. This selection cannot be combined with the LCR, LR, or C sources, but solo and talkback options are concurrent. Each of the monitoring outputs has its own individual USER A / B assignment.</p>		
---	---	--	--	--



Input Solo Select

	<p>Route the Input Solo Signal to the Monitor A, B, and headphone outputs.</p>	<p>The Input Solo signal is defined in the SOLO section of the monitor setup screen. Each of the monitoring outputs has its own individual IN SOLO assignment.</p>		
---	--	--	--	--

Output Solo Select

	<p>Route the Output Solo Signal to the Monitor A, B, and Headphone outputs.</p>	<p>The Output Solo signal is defined in the SOLO section of the monitor setup screen. Each of the monitoring outputs has its own individual OUT SOLO assignment.</p>		
---	---	--	--	--

Talkback Return Select

	<p>Route the Talkback Return Signal to the Monitor A, B, and Headphone outputs.</p>	<p>Each of the monitoring outputs has its own individual Talkback Return assignment.</p>		
--	---	--	--	--

Monitor Follow A

	<p>Force the Monitor B and/or Headphone source assignments to be the same as the MONITOR A assignment.</p>			
---	--	--	--	--

Monitor output format

	<p>Selects one of the stereo format options to be the listening format for the Monitor A, B, and Headphone outputs.</p>	<p>LR - left source to left monitor out and right source to right monitor out • RL - left source to right monitor out, right source to left monitor out • LL - left source to left and right monitor outputs • RR - right source to left and right monitor outputs • Mono - left and right source is summed and fed to left and right monitor. The Centre signal is not affected. Each of the monitoring outputs has its own individual FORMAT selection.</p>		
---	---	---	--	--

Monitoring delay - Fine

		Range Low	Range High
	<p>Fine Control of the monitoring delay time.</p>	<p>Zero Delay</p>	<p>NEEDED</p>



Monitoring delay

			Range Low	Range High
	<p>Adjust the monitoring delay.</p>	<p>The monitor delay allows the headphones and/or monitor speakers to be time-aligned to the output from the main PA system, when working at a distance from the PA speakers. The delay applies to all three monitor outputs (Monitor A, B, and Headphones).</p>	<p>Zero Delay</p>	<p>2000mS</p>

Monitoring delay ON

	<p>Activate/Deactivate the monitoring delay.</p>			
---	--	--	--	--



MON Setup

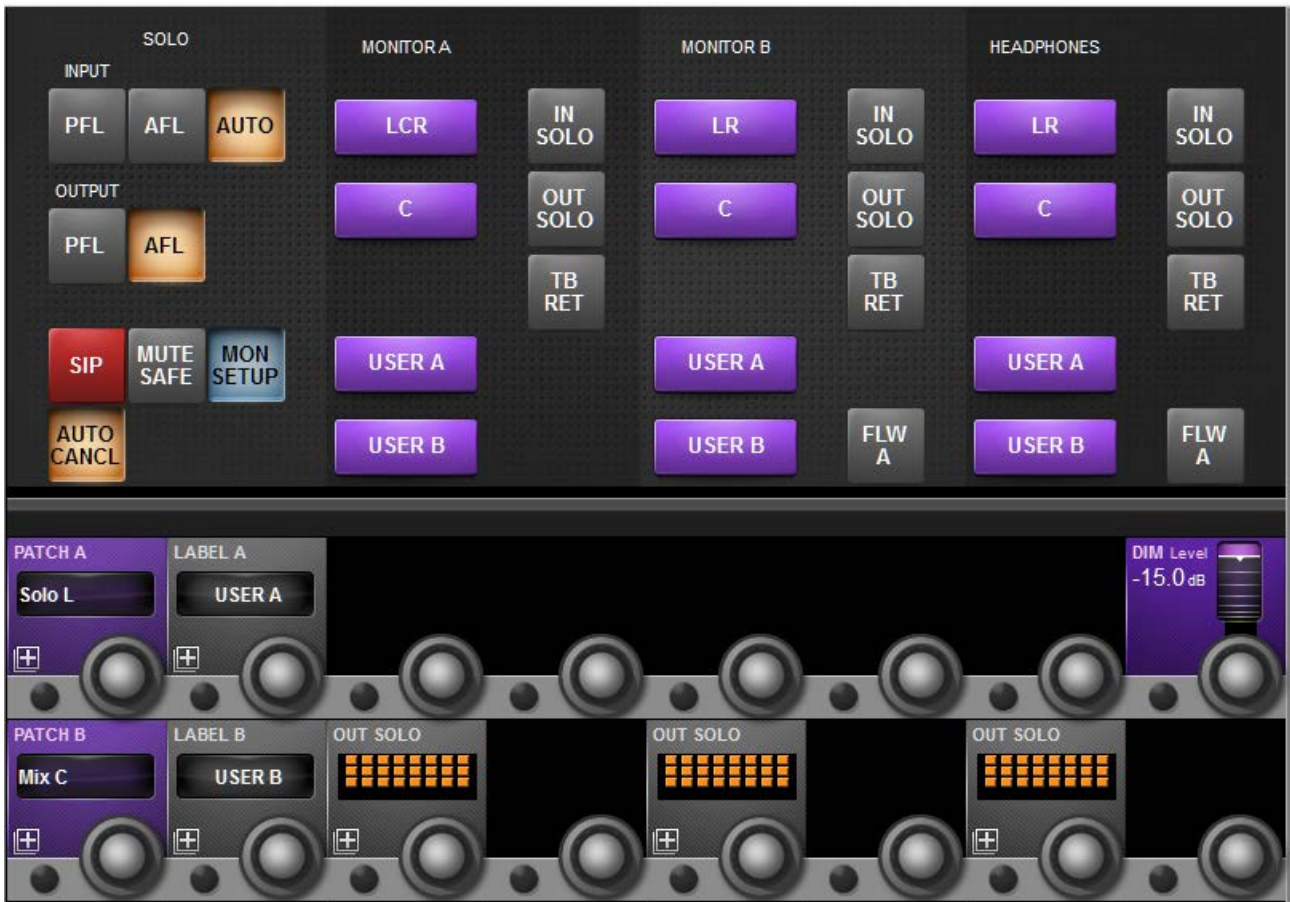

Mon Setup is a sub-screen of the Monitoring setup screen for setting up fundamental configurations such as physical patching and naming for the User sources.

User A and B Patching

	<p>Assign the input, individually, for the User A and User B monitoring sources.</p>	<p>When selected, the source assignment screen is displayed on the touch screen. You can assign any available input, individually, to the left and right User channels - including console I/O, group busses, mix buss channels, and solo channels.</p>		
---	--	---	--	--

User A and B Labelling

	<p>Label the User A and B monitor sources.</p>	<p>When selected the keyboard input screen is shown on the touch screen. You can relabel the 'USER A' and 'USER B' via the screen keyboard or a connected USB keyboard.</p>		
---	--	---	--	--



Outputs Solo Assign

	<p>Assign individual Output Solos to Monitor A, B, and Headphones outputs.</p>	<p>When selected, an output assignment screen is displayed in the master touch screen area. You can select individual output buss solos for the specific monitor output. This is useful for stage monitoring applications where the solos of in-ear monitor mixes could be programmed to appear only on Monitor B for example, which could have an in-ear headphone system connected to it. In this example, conventional wedge monitor mixes could be programmed to appear only on Monitor A when soloed, where Monitor A could be connected to a wedge speaker system.</p>		
---	--	--	--	--

DIM Level

		Range Low		Range High	
	<p>Adjust the monitoring DIM Level between 0 and -infinity.</p>	<p>The DIM function is only activated if the Return Talkback function is activated via the GPIO facility.</p>	<p>-infinity</p>	<p>0dB</p>	



SOLO SYSTEM BEHAVIOUR

AFL, PFL and SIP

The solo system on the Soundcraft Vi3000™ comprises a non-destructive PFL and AFL Solo capability from Inputs and Outputs, and also the option of a destructive Solo-In-Place mode, for use only during soundchecks or rehearsals. Solo-In-Place mode has to be enabled from within the Monitor Setup and changes the mode of operation of the Solo System. It is automatically cancelled if the Monitor Setup screen is closed, to ensure that it cannot accidentally be left on.

PFL and AFL Soloing (SIP Mode OFF)

- Soloing a single Input locally generates a PFL or AFL Solo onto the Solo Bus, depending on the mode selected in the Monitor Setup page (default is AUTO, see next point).
- If the Input Solo Mode is set to AUTO in the Monitor Setup page, soloing more than one Input locally (by pressing and holding the first Solo/Sel switch then pressing others, or switching off AUTO CANCEL mode) will generate an AFL Solo onto the Solo Bus from all soloed Inputs. If a single output is soloed, the solo will be PFL.
- The PFL feed from Mono Inputs is taken after the channel Pan control so the signal heard on the Monitor outs will reflect the Pan setting. If the Input is a Stereo Input, the PFL feed is left channel to left Solo Bus, right to right.
- The AFL feed from Mono or stereo (paired) Inputs is stereo and follows the channel Pan.
- Soloing an Output (either locally or via a VCA Master Solo) generates an AFL or PFL Solo, depending on the mode selected in Monitor Setup (default is AFL for outputs).
The post-fade Output signal is switched onto the Solo Bus.
- In all cases when SIP Mode is OFF, operation of any Solo will switch the audio onto the Solo Bus and the Monitor section will be automatically switched so that the Solo audio replaces the previous monitor source selection (if any) assuming that IN Solo and/or OUT Solo have been selected as a Monitor Source in the Monitor Setup Page.

Solo-In-Place Soloing (SIP mode ON)

- Soloing an Input generates a 'destructive' SIP Solo, actually muting or dimming all other Inputs which are not Soloed or set to Mute Safe, as if you had pressed their channel ON switches. Other channels which are subsequently soloed will be unmuted. The amount of dimming is controlled by the SOLO BLEND control on the front panel.
- Soloing an Input (or group of Inputs) by soloing a VCA Master that the input is assigned to, generates a SIP Solo on all Inputs in the VCA Group.
- * The Input signal is not switched onto the Solo Bus, and the Monitor section does not switch the Solo Bus audio to override the monitor source selection (you hear the soloed signal(s) via the Master LRC busses directly).
- Soloing an Output generates a normal Output AFL or PFL Solo (according to the mode selection made in Monitor Setup), the same as if SIP Mode was OFF. The Output signal is switched onto the Solo Bus and the Monitor section switches so that the Output Solo audio is heard on the Monitors, replacing the previous monitor source, if any.



Solo Operation Logic

Activating Solos

A Solo is activated when any Solo/Sel switch on the console is pressed, as long as the following is true:

- Gang Mode is not active
- VCA or Mute Group Setup page is not open
- Input or Output Fader Page Setup page is not open

Clearing Solos

- All active Solos can be cleared by pressing the momentary Solo Clear switch in the Master Section of the console. This switch illuminates when any Solos are active.
- Solos can be switched off manually.
- Solos can be cleared by pressing other Solos, if AUTO CANCEL mode is enabled (see later in this chapter).

Input Priority Mode

When Input Priority is enabled, via the I/P PRI button in the master bay, it allows an Output Solo to remain active, whilst an Input Solo is temporarily activated 'over the top' of it. When the Input Solo is activated, its audio replaces the Output Solo audio on the Solo Bus, although the Output's Solo/Sel switch remains illuminated. When the Input Solo is deactivated, the Output Solo's audio will return to the Solo Bus.

HINT: Input Priority mode is normally used by Monitor engineers, who tend to work with an Output Solo always active, but occasionally need to solo an input to troubleshoot a problem. The Input Priority mode ensures that they automatically return to the Output Solo they were listening to, after the Input Solo is deactivated.

Autocancel Mode

In the majority of cases in live sound mixing, only one channel is soloed at any time, so it has become common practice for solos to 'autocancel' so that pressing any solo cancels the previous one, and only one solo can be ON at any time. This speeds up operation by eliminating the need to switch solos off before soloing the next channel. In some applications however, such as line checking, it is necessary to keep one channel soloed as a shout talkback feed whilst soloing others, so additive solo is required in these cases. The {Autocancel} On/off switch in the Monitor Setup page allows the behaviour to be set according to requirements. It is also possible to solo more than one channel or bus at a time even if {Autocancel} mode is ON, this is achieved by holding down the first solo whilst pressing the next. This kind of additive solo is temporary however, and the next solo to be pressed will cancel all of the active solos.

Input priority and Autocancel mode work together if both enabled so that Output Solos cancel among themselves and input solos cancel among themselves, but Input Solos do not cancel Output solos or vice versa.

Follow Output Solo Mode

A key feature of modern digital consoles is a method of assigning the channel faders to control Aux send levels for monitor mixing. On the Vi3000, this mode is called 'Follow' mode, meaning that the Input faders will Follow the selection of the Output bus solo, which doubles as a bus select switch.

Follow mode is engaged using the distinctive, triangular Follow Output Solo [FLW] keys. There are three [FLW] keys: one fader key and two Vistonics area keys. Only one key can be active at any one time (or none can be selected). Selecting Follow mode for the Vistonics area means that a horizontal row of Vistonics encoders will be assigned across the whole console to the contribution levels of the currently soloed bus. There is one [FLW] key for the upper Vistonics row and one for the lower row. To use Follow mode on Vistonics area, the Vistonics screens must have all processing views deselected.

- If Follow Solo is NOT active for faders or Vistonics encoders, pressing a Group or Aux Output Solo will activate an



Output Solo, and it will also display the EQ/Dyn/Misc touch screen area for the Soloed Output, on the Master section touchscreen (in the space normally occupied by the Input Meter overview display).

- If Follow Solo IS active for either faders or Vistonics encoders, pressing a Group or Aux Output Solo/Sel will work as described above, and will also switch the input channel faders or encoders to be assigned to the Soloed bus's contributing sends (equivalent to 'Sends On Faders' on some other consoles). The Faderglow colour will illuminate in this case to indicate the type of bus contributions being assigned to the input faders: Orange for Aux sends and Green for Group sends (although the faders themselves have no function with Group sends - only the channel ON keys are used).
- If a Matrix Output Solo/Sel is pressed, regardless of the setting of Follow Solo modes, the Output Solo will be activated, the EQ/Dyn/Misc touch screen for the Matrix Output displayed, and the channel faders will be assigned to the contribution levels from the Outputs to the Soloed Matrix Output. The Faderglow of input faders will change to Pale Blue (Cyan) to indicate Matrix contributions are now being controlled.

Whilst an Output Solo is active, the [FLW] key can be pressed at any time to drop out of Follow mode and switch back to channel faders for global level adjustments, and then pressed again to drop back into Follow mode for adjustments to contribution mix again.

The [FLW] key for fader area is automatically switched on when you load the Monitor Default Show, as this functionality is primarily intended for monitor mixing.

Note: the [FLW] key for fader area has an additional function in allowing VCAs to control the Aux sends of input channels. See chapter 9 for details.

Console Metering



Level metering in the Vi 3000 goes from +18dB to -36 dB. It represents the actual output level in dBu from its analogue line output. Gain reduction is displayed in the Range 0 - 20dB. The Vi 3000 uses full floating-point calculations in its DSP, which means that the audio signal inside the mixer cannot be overloaded. If the signal level is too high at the master output meters, it is necessary only to pull down the master fader level until the correct level is obtained.

There are meters on every channel and bus master, plus metering for every console path in the default Master Bay touchscreen areas.

The touchscreen meters can be touched to assign the third (right-hand-end) input bay mapping.

Input Channel Metering

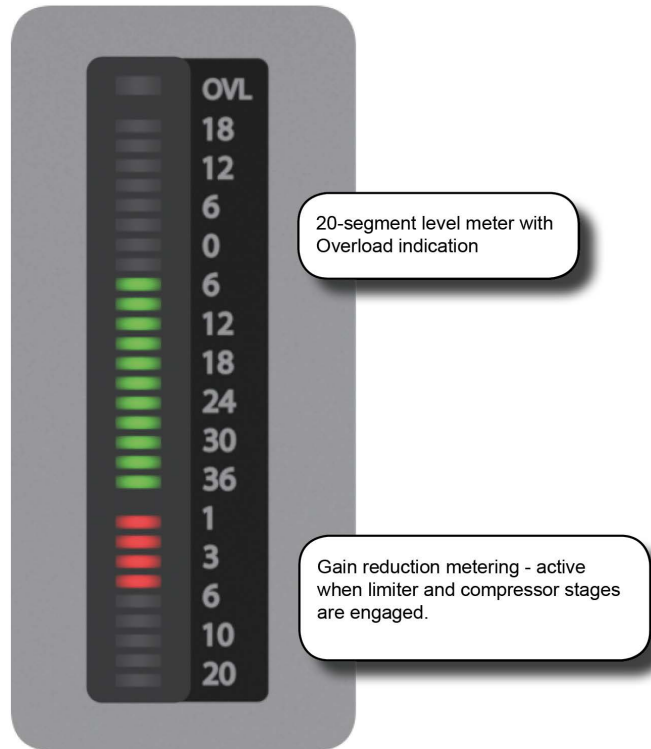

Each input channel has an input meter and every input meter has two parts: A 20--segment level meter (top), and a 9-segment Gain Reduction Meter (GRM).

Both the measured point in the channel signal flow and the metering peak hold time can be selected in the main settings screen (via the [MENU] button), in the (Settings) tab.

Input Level Meter

	<p>Shows the input level at the selected point in the input channel signal path.</p>	<p>The overload (OVL) LED indicates an overloaded analogue input (mic preamp clipping).</p>		
---	--	---	--	--

Input Gain Reduction Meter

	<p>Shows the overall gain reduction of the limiter and compressor stages, if they are engaged.</p>			
---	--	--	--	--



Bus Master Metering

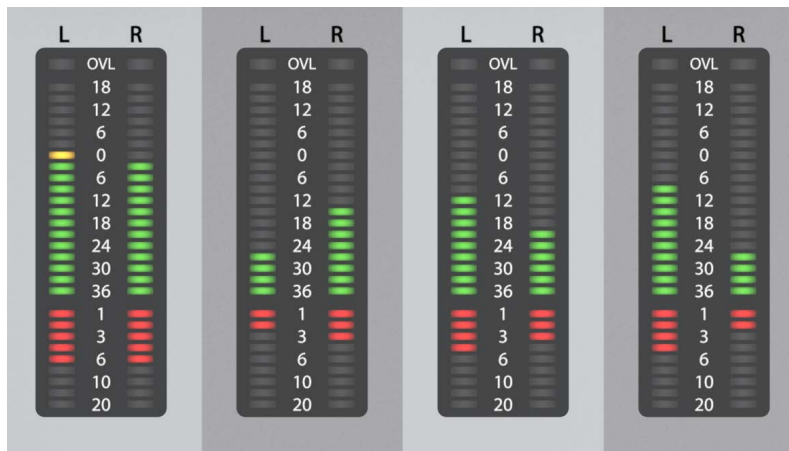

Bus Meters

	<p>Show the buss master signal levels.</p>	<p>Bus Masters can be configured as stereo channels, therefore the Bus Master Strip level meters have left and right meters (i.e. the left and right channels share a single set of controls, but note that this feature is reserved for a future release). The GRM shows the overall gain reduction of the limiter and compressor, if they are engaged. The Dynamics from Stereo Bus Masters are always linked, therefore both GRMs show the same value.</p> <p>The overload LED indicates a value that is higher than Full Scale (analogue output-stage clipping).</p>		
---	--	--	--	--

Mix Master Meters

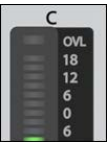
	<p>The L,R and C Output Masters each have a Level Meter and a Gain Reduction Meter. The L and R masters share a stereo meter, and the C master has a mono version.</p>	<p>The overload LED indicates a value that is higher than Full Scale (analogue output-stage clipping).</p>		
---	--	--	--	--

Monitor Bus Metering

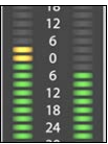
	<p>The monitor section has a stereo level meter, but there is no GRM associated with the monitor.</p>			
---	---	--	--	--

Edit & Library System - Copy, Paste, Undo, and Library Storage

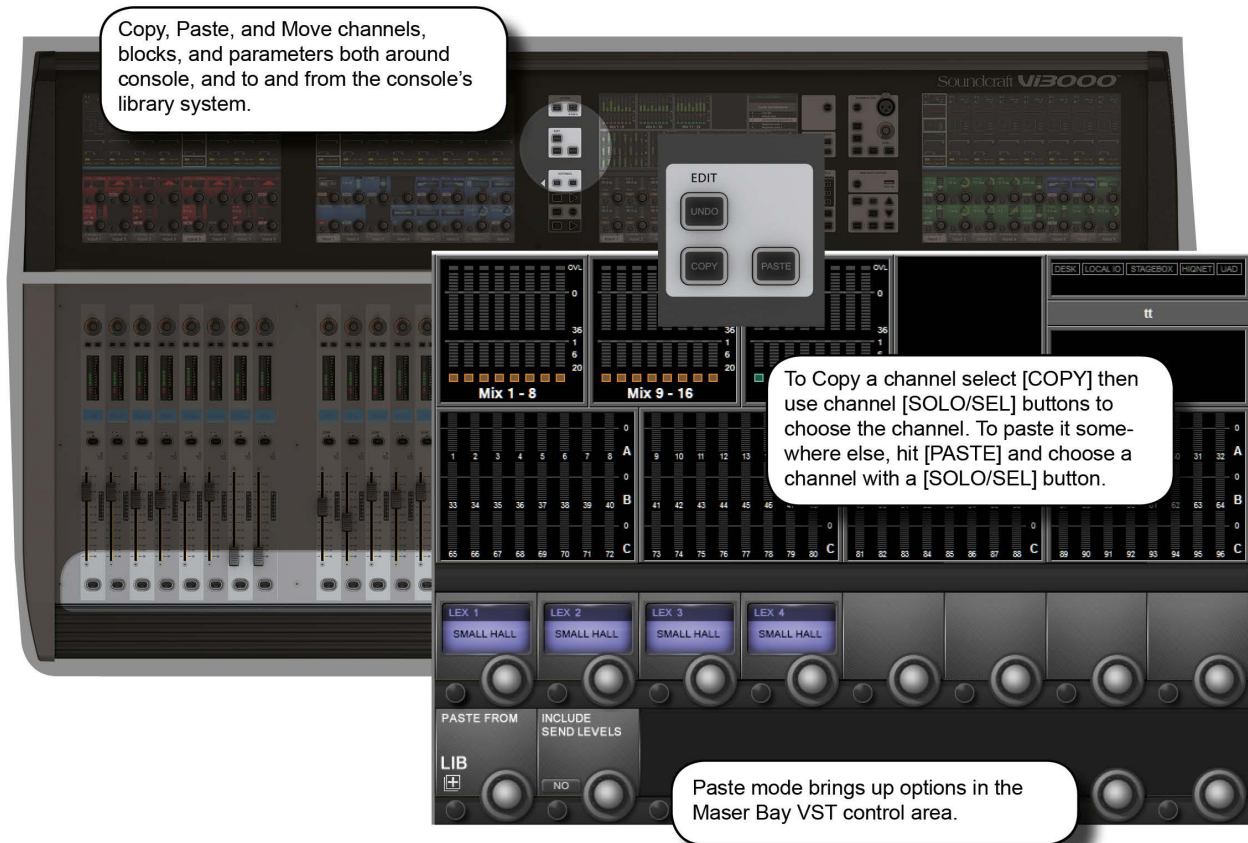

The Copy/Paste function allows the settings of any channel, bus, FX section or processing element to be copied and pasted to any number of other channels, saving set up time and helping eliminate errors.

The Copy and Paste modes also work with the console's powerful Library functionality. This allows you to select any set of parameters in use on the desk and store them in the internal library, independent of the Show Files, and export to or import from a USB storage device.

If the console is in either copy or paste mode a yellow bar appears across all the Input Screens and the console switches into 'Copy/Paste' mode, which is where the surface is used for item selection rather than control. In addition, the VST area of the Master Bay Vistronics displays the Lexicon FX blocks (for convenient selection) and the {LIB} Library access button.

In these modes control of channel strip audio from the Vistronics screens is not possible.



13.1: Copy, Paste, Undo

Ranges of channels or busses, individual channels or busses, processing blocks (eg EQ), or even individual parameters (eg mic gain control) within a processing block can be copied to the clipboard then pasted to another channel, block, or range. This includes the console's internal Lexicon FX units.

The last paste operation can be quickly reversed with the UNDO function.

Copy, Paste, and Undo

				Active
	Put the console into Copy mode.	Used for selecting channels, processing blocks, and parameters and copying them to the clipboard. In copy mode, the console [SEL] keys illuminate in blue to indicate their function as selects rather than as Solos.		Copy Mode Active

Copy Options

- Put the console into Copy mode.
- Copy A Channel Or Bus Master

In copy mode, select or deselect a full input channel or output bus by pressing its [SEL] Key. Select a range by holding the [SEL] Key of the first Channel and pressing [SEL] of the last Channel. When a whole channel or range of channels are selected, the grey Channel border is replaced with a yellow border.

Some parameters or process blocks are not included with a channel or bus copy by default, but most can be added to the copy by selecting them individually (see below). The only ones that CANNOT be added are the Insert Point and Direct Output settings.

Parameters not included with a whole input channel copy but that CAN be added individually are: Input 1/2 switch, Input 1 & 2 patch, Mic Input Gain and all associated switches (48V, PAD, Phase Inv etc), Fader and Mute, VCA & Mute Group Assignment, FX settings.

Parameters not included with a whole bus copy but that CAN be added individually are the output patch and FX settings.

• Copy A Block

Select or deselect a function block by touching that block's Touch field. Indication that a whole function block is selected is shown with a wide yellow indicator in the top left corner of the field.

• Copy A Parameter

Select a single parameter by touching the corresponding Rotary encoder or by pressing the small key to the left of the encoder. To make access to parameters easy while in Copy mode, enter the 'Zoom' mode with a long press on a touch field. Alternatively you can enter the Zoom mode, before you activate Copy mode by pressing the touch field in the normal way and entering Copy mode.

A selected parameter is indicated with yellow text in the Parameter Label. Note that not all parameters can be selected individually; in some cases a set of parameters will automatically be selected when one of the set is touched.

If only a set or a single Parameter from within a block is selected then a small yellow indicator is displayed.



• Copy FX

To make selection of the source and destination Lexicon FX units easy, a set of four FX-select encoders appears on the central screen in both Copy and Paste modes. The selection is made by either touching the relevant encoder or pressing the corresponding Vistonics button beside the encoder. If the FX unit is assigned to a channel or bus then the units can be selected by touching the FX block on the channel strip.

Note that only the parameters relating to the currently active FX Type are copied/pasted for each unit. For example, if LEX1 is selected, and is currently set to the Small Hall FX type, then only the Small Hall parameters will be copied.

Paste

Active

	<p>Enter paste mode to Paste any channels, processing blocks, parameters, or Lexicon FX settings (selected in Copy mode) to a new destination.</p>	<p>To paste anything selected in Copy mode, press [Paste] to enter Paste mode, then select the destination channel by pressing its [SOLO/SEL] button or touching any VST field on the channel. The clipboard content is immediately copied to each selected channel. Once you have finished, press the [PASTE] button again to exit Paste Mode and enter normal operation.</p> <p>IMPORTANT! Remember to switch PASTE mode off immediately after use, otherwise accidental pasting of the clipboard will occur the next time you touch a screen or press a Solo/Sel.</p>		<p>Paste Mode Active</p>
--	--	---	--	--------------------------

Undo Edit

	<p>Undo the last paste operation.</p>			<p>Copy Mode Active</p>
---	---------------------------------------	--	--	-------------------------



Libraries

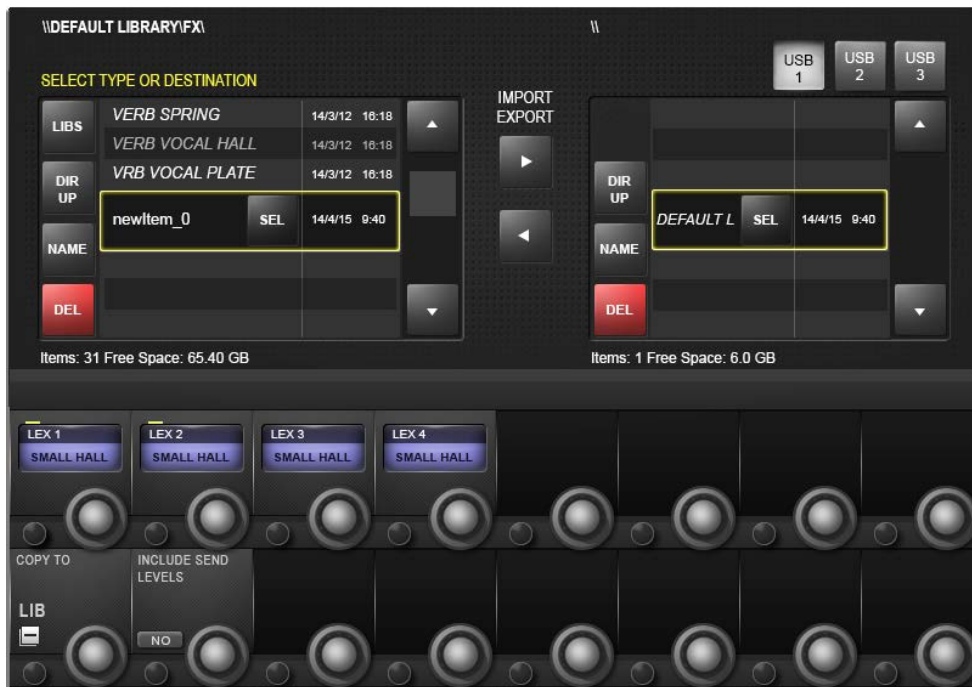

The Libraries functionality enables various elements of the console, eg EQ section, Dynamics section, or complete channels and busses, to be copied from the desk and stored in the Library system. Later these items can be retrieved and pasted from the Library to any destination channel or bus on the console. You can also export complete Libraries or individual entries to a USB stick, allowing you to move Libraries between consoles.

The {LIB} button appears in the bottom left corner of the VST section in the Master Bay Viconics screen when in either Copy or Paste mode. It works in much the same way as the basic copy and paste mode. To Paste from the library simply hit the [PASTE] button, select a library item, then touch a target on the console. To Copy to the Library, put the console in Copy mode, select console blocks (see the Copy/Paste section) then hit the {LIB} button. The selection will be saved to the currently loaded Library. To save selections to a different Library, you must load that library - or create a new one - first.

Library Access

ACTIVE

	<p>Access Library functionality while in Copy (Copy To Library) or Paste (Paste from Library) modes.</p>			
--	--	--	--	--

Include Send Levels

	<p>Include Send Levels in Library Copy and Paste operations.</p>			
--	--	--	--	--



Library - Library Folders

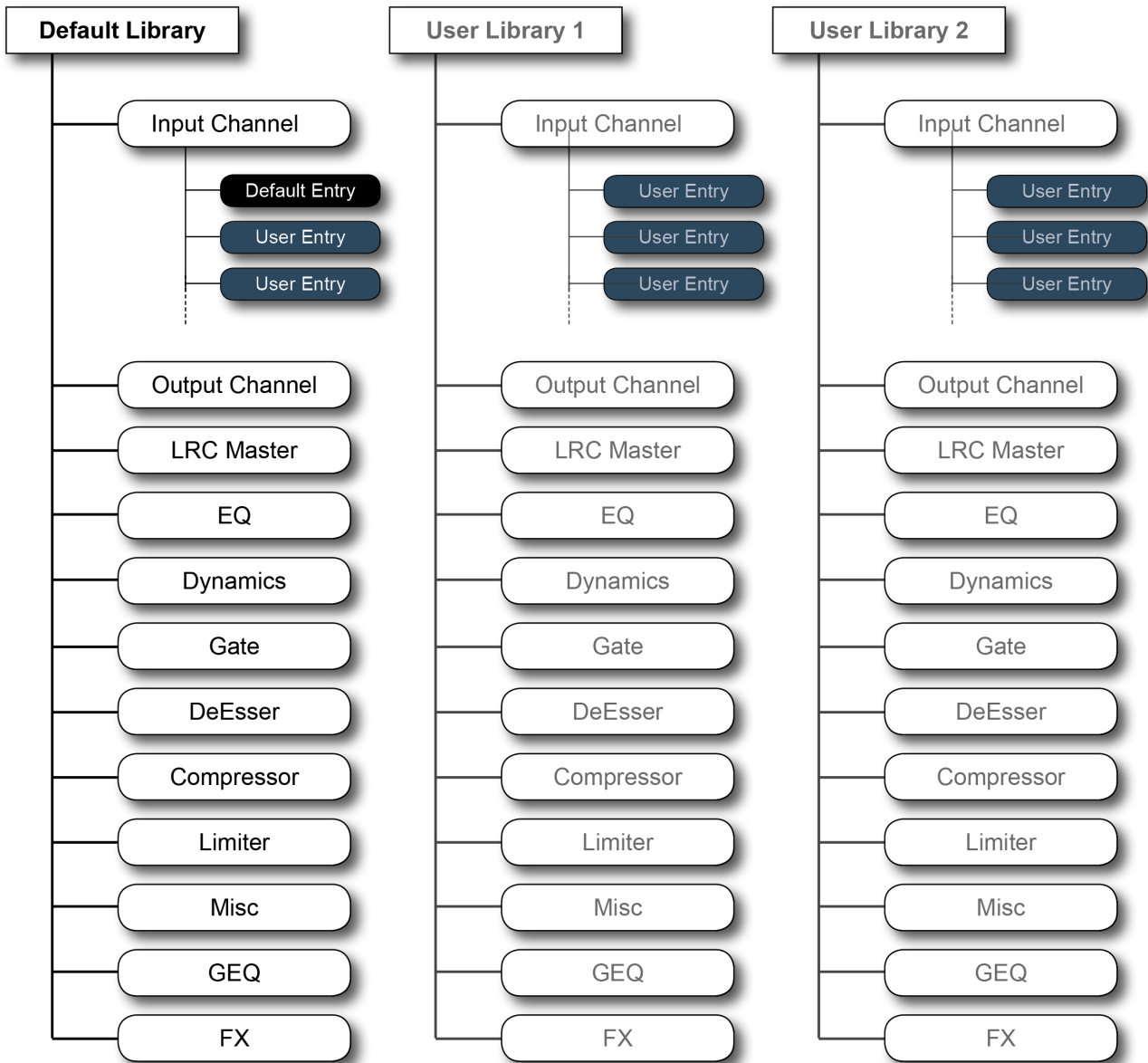

Library Folder Structure

The Library File System

The Library file system itself comprises a system of folders that reside on the console's internal flash drive. The folder structure is preset to comprise a top-level Library folder, within which are sub-folders called Categories, corresponding to the various types of functions that can be stored in the Library (EQ, Dynamics, Channels, and so on). Within each Category, the actual Library settings are stored - these are called Entries. This structure and the names of the folders are fixed and cannot be modified.

Also, only elements that have a Category can be stored individually to the Library – For example, there is no Category



for the Input stage (gain, PAD etc) or the Aux send parts of the channel strip, so these parameters cannot be stored to the Library other than as part of complete channel strips using the Input Channel Category.

The Misc Category is intended for storing combinations of channel or bus parameters. Currently, only a combination of EQ and Dynamics can be stored in the Misc category, but this may be extended with a future software update.

Default Library

The console comes with one pre-installed Default Library. This Default Library contains factory presets for a variety of common applications. These factory default library entries are 'read-only' and cannot be deleted.

A mechanism exists for the default entries in the Default Library to be updated via a special update procedure. New, modified or additional default entries may be released from the factory from time to time in the form of a web download that can be copied to a USB stick and transferred to the console.

New Entries can be stored in the Default Library, alongside the read-only factory default Entries, or one or more new Libraries can be created which will then only contain user-stored Entries.

User Libraries

In addition to the Default Library, as many additional new Libraries can be created as required. Either a new empty Library can be created or the existing Default Library can be duplicated using the Save As function, creating a new Library that also contains the factory default Entries. When a new empty Library is created, only the folder structure is created – the Library itself contains no Entries and needs to be populated by the user.

The only limit to the number of Libraries or entries that can be created is available disk space in the console, but the file size of each Library entry is very small (typically less than 100kB for individual single channel Entries).

LIBRARY FILE SCREEN



The Library file system appears in the Master Bay Viconics screen when the {LIB} button is pressed in Copy or Paste Mode. It allows you to navigate the console library and perform import/export operations with connect USB storage devices.

Important! In Copy mode you must have your intended target library loaded before copying.

File Path

	<p>Always shows the currently selected directory, and the file path to it.</p>			<p>Copy Mode Active</p>
---	--	--	--	-------------------------

Library

	<p>Navigates directly to the Library directory.</p>			
---	---	--	--	--



Directory UP

	<p>Navigate the file tree upwards, to the next 'parent' directory.</p>			
---	--	--	--	--

**Name Folder/
File**

	<p>Name the currently highlighted Library or library item.</p>			
---	--	--	--	--

**Delete Folder/
File**

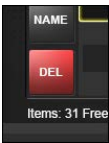
	<p>Delete the currently highlighted Library or Library item.</p>	<p>You cannot delete a Library that is currently loaded.</p>		
--	--	--	--	--

Save As

	<p>Save a copy of the library under a new name.</p>			
---	---	--	--	--

New Library

	<p>Create a new (empty) User Library.</p>	<p>The {NEW} button only appears at the Library directory level.</p>		
---	---	--	--	--

**Select Folder/
File**

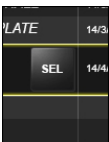
	<p>Select the highlighted item.</p>	<p>Libraries that are currently loaded will have the {SEL} button and be labelled in yellow text. Libraries that are not loaded have the {LOAD} button.</p>		
---	-------------------------------------	---	--	--

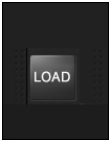

Load Library

	<p>Load the highlighted Library.</p>			
---	--------------------------------------	--	--	--

Export/Import Library/Item

	<p>Import or export a Library or Library item to or from the selected USB storage device.</p>	<p>For example, with a Library item selected in the internal Library (right hand side of the file screen) and a USB storage device selected, hitting the Export arrow will copy the selection into currently selected Library on the storage device, into the correct category.</p>		
---	---	---	--	--

USB Storage Select

	<p>Select a connected USB Storage device.</p>			
--	---	--	--	--



Snapshots, Cuelists, and Global Filtering

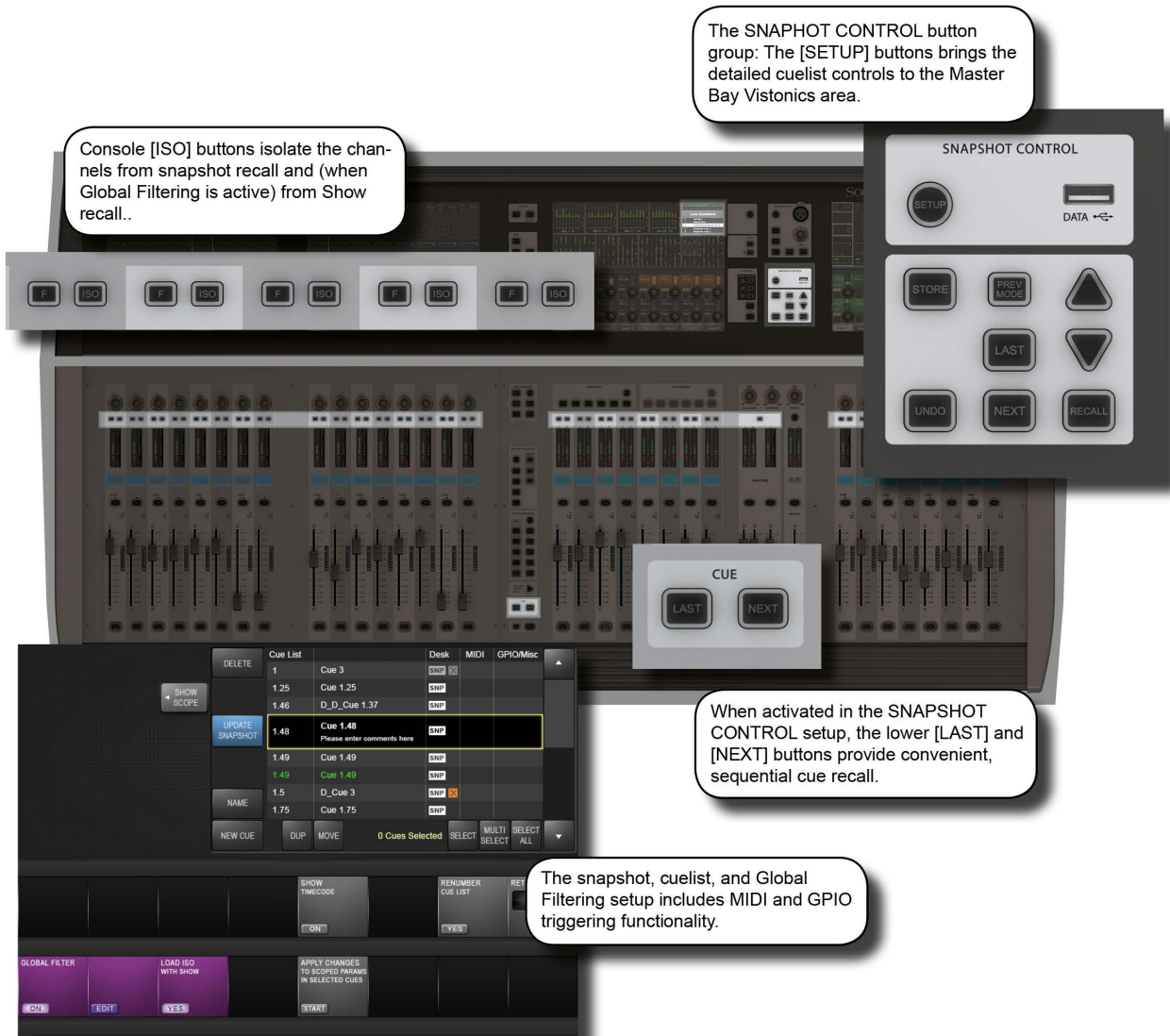

Snapshots are records of parameter settings across the console. Snapshots are stored in and recalled from cues in the cuelist. Cues can also trigger (or be triggered by) timecode, MIDI, and GPIO events. The 'scope' of a snapshot describes which parts of the console are included in the snapshot recall, and which parts are left out. Scope is set individually for every snapshot.

There is a separate snapshot filtering system called 'global filtering' which affects all snapshots. This uses the [ISO] buttons on the console. The global filtering system can isolate console channels, blocks, and parameters from both snapshot and show file recall.

Details on all aspects of snapshots, cue lists, and global filtering are included in this reference chapter.

14.1: Snapshot, Cuelist, and Global Filter Console Controls

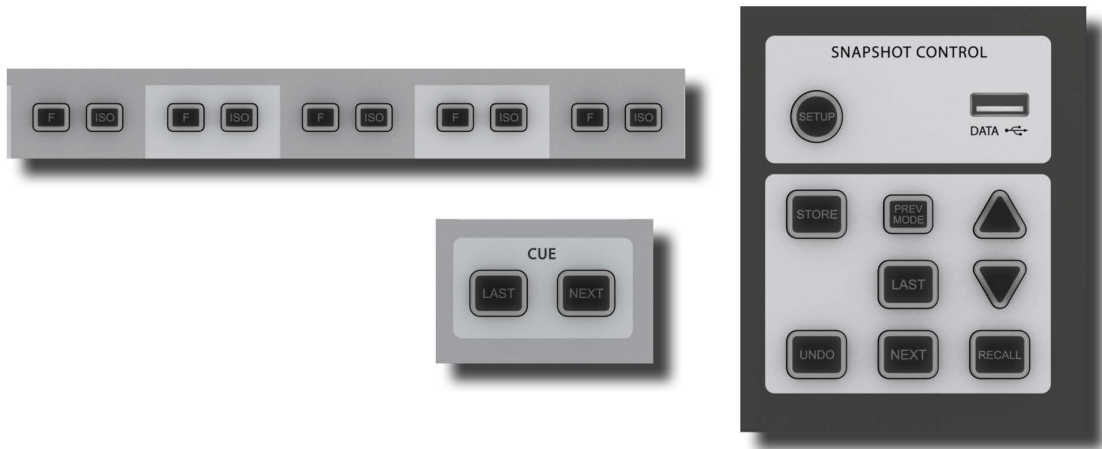

The main console snapshot controls are found in the 'SNAPSHOTS' group of buttons in the Master Bay. The 'ISO' (Isolate) button in the channel strips also plays an important role by allowing you to keep selected channels and sections 'protected' from snapshot (and Show) recall.

Snapshot/Cues Setup

Active

	Access snapshot and cue filtering set-up page in the Master Bay touch screen.		Show setup screen
--	---	--	-------------------

Data Sockets

Active

	Accept USB Storage devices for show storage and Media playback.	There are two more USB sockets on the rear of the console.	Show setup screen
--	---	--	-------------------

Undo Action

	Undo the effect of pressing the [RECALL], [NEXT], or [LAST] buttons.		
--	--	--	--

Store Snapshot

Active

	Store a snapshot of the current console state into a new cue and open up the Snapshot/ Cue settings page in the Master Control screen.	The new cue will be stored and numbered between the currently selected cue and the next. For example, if you have selected cue 2 of 3 and then press the [STORE] button, the new cue will be numbered 1.5. If you have cue 3 of 3 selected, the new cue will be numbered 4.	Store snapshot
--	--	---	----------------



Preview Mode

Inactive

Active

	<p>Make the cue list available for preview via the cue selection buttons [LAST], [NEXT], [UP], and [DOWN].</p>	<p>When Preview Mode is deactivated, the cue list will return to the cue selected before Preview Mode was activated.</p>	<p>Normal</p>	<p>Activate Preview Mode</p>
---	--	--	---------------	------------------------------

Recall Last Cue

	<p>Select AND recall the previous cue in the cue list.</p>			
---	--	--	--	--

Recall Next Cue

	<p>Select AND recall the next cue in the cue list.</p>			
--	--	--	--	--

Recall Selected Cue

	<p>Recall a cue that has been pre-selected with the [UP] and [DOWN] keys</p>			
---	--	--	--	--

Up / Down Cue List

	<p>Pre-Select cues by scrolling up and down the cue list. Press [RECALL] to load that cue.</p>			
---	--	--	--	--

Isolate From Recall

	<p>Isolate ('protect') this channel or selected parameters from the effects of snapshot recall or Show recall.</p>	<p>The [ISO buttons are found on the console channel strips. This function requires the GLOBAL FILTER parameter set to 'On' (default) in the Snapshot settings screen. Isolate whole channels by pressing that channel's [ISO] button. Isolate sections, processing blocks, and so on by holding an [ISO] key down and selecting those blocks/sections. Any isolated channel or selection will not be affected by the RECALL of a snapshot from the cue list. If you have 'LOAD ISO WITH SHOW' (Snapshot Set-up) set to 'No' then your selections will also be isolated from a Show load. See the Snapshots Filtering And Isolation section below for more information. In addition to it's usefulness in performance, the ISO function can also be useful for updating snapshots with new settings. For example, you could update a channel's EQ settings, isolate it, then recall cues and 'UPDATE CUE' with the new settings.</p>
---	--	--



14.2: Cuelist Control



The Cue List shows all stored cues in the current Show's cuelist in several columns of information. A large cuelist and controls appears in the Master Bay touchscreen area when the Snapshots Controls [SETUP] button is pressed or when a snapshot is stored. The cuelist is also displayed next to the channel meters in the the Master Bay touch screen during normal operation.

Cue Selection

	<p>Select next and previous snapshots in the cue list.</p>	<p>Like the [UP] and [DOWN] buttons on the console, these buttons select the cue but do not recall a snapshot. Pressing [RECALL] will recall a selected snapshot. These buttons are also used to select multiple cues, together with the (SELECT) and (MULTI SELECT) keys.</p>		
--	--	--	--	--

Delete Cue

	<p>Delete selected cue / cues.</p>	<p>You will be asked "Are you sure you sure you want to delete the selected cue/s?" and given response options (YES) or (NO).</p>		
--	------------------------------------	---	--	--



New Cue

	<p>Store a snapshot of the current console state into a new cue.</p>	<p>The new cue will be stored and numbered between the currently selected cue and the next. For example, if you have selected cue 2 of 3 and then press the [STORE] button, the new cue will be numbered 1.5. If you have cue 3 of 3 selected, the new cue will be numbered 4.</p>		
---	--	--	--	--

Duplicate Cue

	<p>Duplicate the currently selected cue or cues.</p>	<p>If multiple cues are selected, the duplicates will be stored sequentially, after the final cue in the selection. Duplicate cues are renamed with a 'D_' prefix.</p>		
---	--	--	--	--

Move Cue

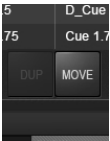
	<p>Move the selected cue or cues to a new position in the cue list.</p>	<p>The (MOVE) button becomes the (DROP) button when selected.</p>		
--	---	---	--	--

Select Cue

	<p>Add the currently highlighted cue to a selection of multiple cues.</p>	<p>To create a multi-selection of non-contiguous cues, highlight cues with the (UP) and (DOWN) buttons and click (SELECT) to add them to the selection.</p>		
---	---	---	--	--

Multiselect Cues

	<p>Create a contiguous selection of multiple cues.</p>	<p>To select multiple, contiguous cues, highlight the first or last in the selection, click (MULTI SELECT), then select the range with the (UP) and (DOWN) buttons.</p>		
---	--	---	--	--

Select All Cues

	<p>Select all cues in the current cue list.</p>			
---	---	--	--	--



Update Snapshot

	<p>Update the snapshot in the currently selected cue to current console settings.</p>			
---	---	--	--	--

Show Timecode

	<p>Show the recall time-code for all cues in the cue number column of the cue list.</p>			
---	---	--	--	--

Renumber Cuelist

	<p>Renumber all cues in the cue list as consecutive integers.</p>	<p>Cue names, which may incorporate the original cue numbering, remain unchanged.</p>		
--	---	---	--	--

Scroll The Cue List

	<p>Scroll through the cue list using the encoder.</p>	<p>Usually faster than the Up and Down buttons.</p>		
---	---	---	--	--

Apply Changes To Scoped Parameters In Selected Cues

		Inactive	Active	
	<p>Mode used to apply new settings to selected cues.</p>	<p>Select {START} to enter this mode. You can then use the scope settings to filter process and channel selections, and use the cue list's cue-selection functions to choose which cues will be affected. Only 'scoped' selections will be applied to selected cues when you click the {APPLY} button. You can click the {CANCEL} button at any time to leave this mode.</p>	<p>Normal Operation</p>	<p>Enter 'Apply Changes Mode</p>

14.3: Cue Details

Cue List		Desk	MIDI	GPIO/Misc	
1	Cue 3	SNP <input type="checkbox"/>			▲
1.25	Cue 1.25	SNP			
1.46	D_D_Cue 1.37	SNP			
1.48	Cue 1.48 Please enter comments here	SNP			
1.49	Cue 1.49	SNP			
1.49	Cue 1.49	SNP			
1.5	D_Cue 3	SNP <input checked="" type="checkbox"/>			
1.75	Cue 1.75	SNP			

DUP
MOVE
0 Cues Selected
SELECT
MULTI
SELECT
SELECT
ALL
▼

Four segments / columns of each cue entry in the cuelist can be touched to enable extended functionality via the Master Bay Vistonics VST area. For example, by touching the Cue 2 entry in the cue list, in the MIDI column, that cue's MIDI functions (MIDI-based recall and a MIDI message output list) will be available in the VST area.

Also, touching the column headers in the cuelist will disable or enable that aspect of all cues. For example, touching the MIDI column header will disable MIDI functions in all cue recalls. Touching again will enable them.



14.3.1: Cues: Number and Timecode



Selecting a cue number in the cue list gives access to that cue's basic settings, plus MIDI timecode recall event settings and the GO TO CUE 'local' sequencing function.

Timecode On/ Off

	Activate MIDI timecode-based recall for this cue.			
--	---	--	--	--

Copy Timecode

	Copy the current incoming MIDI timecode to the cue's recall TIMECODE fields.			
--	--	--	--	--

Set Timecode

			Range Low	Range High
	Manually set or adjust the MIDI timecode at which the cue is recalled.	Encoders adjust H (Hours), M (Minutes), S (Seconds), and F (Frames).	0 time	dependant on field



Enable Cue

Inactive

Active

	<p>Enable or disable this cue.</p>	<p>Enabled cues are shown in white in the cue list. Disabled cues are shown 'greyed out'.</p>	<p>Cue Disabled</p>	<p>Cue Enabled</p>
---	------------------------------------	---	---------------------	--------------------

Enable Cue

Inactive

Active

	<p>Enable or disable this cue.</p>	<p>Enabled cues are shown in white in the cue list. Disabled cues are shown 'greyed out'.</p>	<p>Cue Disabled</p>	<p>Cue Enabled</p>
---	------------------------------------	---	---------------------	--------------------

Go To Cue Number Select

Range Low

Range High

	<p>Set a following cue number - to be recalled a set amount of time after this cue has been recalled.</p>	<p>Can be very useful for firing a number of events from one cue activation.</p>	<p>First Cue</p>	<p>Last Cue</p>
--	---	--	------------------	-----------------

'Go To Cue' On

Inactive

Active

	<p>Activate the GO TO CUE functionality for this cue.</p>		<p>OFF</p>	<p>ON</p>
---	---	--	------------	-----------

'Go To Cue' Time

Range Low

Range High

	<p>The amount of time that will elapse before the 'GO TO CUE' cue is recalled.</p>		<p>0.5 Secs</p>	<p>30 Secs</p>
---	--	--	-----------------	----------------

14.3.2: Snapshot detail



Selecting a snapshot name in the cue list gives access to that cue’s snapshot-specific settings and functions.

Enable UA Realtime Rack Snapshot Recall

	Enable snapshot recall for connected Soundcraft / Universal Audio Realtime Racks.			
--	---	--	--	--

Snapshot Recall Enable

	Enable or disable the snapshot in this cue.	This is enabled by default, though you can choose to disable it and therefore only trigger cue-based events such as MIDI outputs and GPO events.		
--	---	--	--	--

Snapshot Notes

	Activate keyboard entry for snapshot notes. You can use the on-screen keyboard or an external USB keyboard.		Clear Notes Screen	Display Notes Screen
--	---	--	--------------------	----------------------



Scroll The Cue List

	<p>Scroll through the cue list using the encoder.</p>	<p>Usually faster than the Up and Down buttons.</p>		<p>Cue Enabled</p>
---	---	---	--	--------------------

Scroll The Cue List

	<p>Scroll through the cue list using the encoder.</p>	<p>Usually faster than the Up and Down buttons.</p>		<p>Cue Enabled</p>
---	---	---	--	--------------------

XFade On

	<p>Activate snapshot-to-snapshot cross fading function</p>	<p>Can be very useful for firing a number of events from one cue activation.</p>	<p>First Cue</p>	<p>Last Cue</p>
--	--	--	------------------	-----------------

Crossfade Time Setting

	<p>Adjust duration for snapshot crossfades.</p>		<p>100mS</p>	<p>30Secs</p>
---	---	--	--------------	---------------

Switches

				<p>30 Secs</p>
---	--	--	--	----------------

14.3.3: Cue MIDI Detail



Selecting the MIDI column in a cue list entry gives access to that cue’s MIDI input trigger and output settings. The output section defines an event list of MIDI messages that are sent when the cue is triggered. Note that some options rely on, or are governed by, global MIDI settings, accessed via the Settings menu.

MIDI Input Triggering Enable

	<p>Activate the MIDI input recall trigger for this cue.</p>	<p>When active, this cue will be recalled when the specified MIDI message is received from the specified MIDI device.</p>		
---	---	---	--	--

MIDI In Message Type

	<p>Select a message type to be the cue recall trigger.</p>	<p>New VST area fields will be activated depending on which MIDI message type is selected. For example, if a Note On message is selected, only the {NOTE VALUE} field will be available. If a Controller message is selected, then {CONTROLLER NUMBER} and {VALUE} will be available. When any valid message is selected, the {CHANNEL} field becomes available.</p>		
---	--	--	--	--



MIDI In Message Learn

			Inactive	Active
	Activate Learn mode for MIDI input message type.	When LEARN mode is active, the next MIDI message received will be entered into the MIDI message fields.	Normal Operation	Learn Mode Active

MIDI Input Channel

	Select a MIDI device as the recall trigger 'carrier'.	MIDI devices are set up in the master MIDI Settings section, though default to numbered (and available) MIDI inputs and channels. A Global device is also available, which defaults to 'OMNI' but can be customised in the master MIDI settings section.		
---	---	--	--	--

MIDI Output Enable/Disable

				Active
	Enable or Disable MIDI output for this cue.	A Cue's MIDI output consists of a message event list that is transmitted when the cue is triggered.		Cue MIDI Out enabled

MIDI Output Event Number

			Range Low	Range High
	Set the MIDI output event number to be edited.	There are up to 20 MIDI output events available for each cue.	1	20

MIDI Output Event List

	When selected, the MIDI event list for this cue is displayed in the 'section scope' section of the snapshot settings screen.			
---	--	--	--	--

MIDI Out Event Message Type

	Select a message type for the selected MIDI event.	New VST area fields will be activated depending on which MIDI message type is selected. For example, if a Note On message is selected, the {NOTE VALUE} and {VELOCITY} fields will be available. If a Controller message is selected, then {CONTROLLER NUMBER} and {VALUE} will be available. When any valid message is selected, the {CHANNEL} field becomes available.		
---	--	--	--	--

14.3.4: Cue GPIO Detail



Selecting a the GPIO column in the cue list gives access to that cue’s GPIO (General Purpose Input Output) settings. The VST screen is split into GPI (input) and GPO (output) sections. The inputs section sets an input to be used as a recall trigger for this cue, while the output section defines an output to be triggered when the cue is recalled. The cue GPIO system uses ‘virtual pins’ that are mapped to physical pins in the master GPIO settings screen.

GPI On

Active

	<p>Enable GPI triggering for recall of this cue.</p>		<p>Enable GPI for this cue</p>
---	--	--	--------------------------------

GPI Virtual Pin Select

Range Low

Range High

	<p>Select a virtual GPIO pin as a recall trigger for this cue.</p>		<p>0</p>	<p>80</p>
---	--	--	----------	-----------



GPI Pin Steal

	<p>'Steal' a virtual GPIO pin that is being used by the main GPIO system.</p>	<p>Stealing a GPIO pin deactivates the GPIO mapping that is set up in the main GPIO Settings section.</p>		
---	---	---	--	--

GPI Pin Steal

	<p>'Steal' a virtual GPIO pin that is being used by the main GPIO system.</p>	<p>Stealing a GPIO pin deactivates the GPIO mapping that is set up in the main GPIO Settings section.</p>		
---	---	---	--	--

GPI Physical Pin

	<p>Displays the physical pin number that corresponds to the selected virtual pin.</p>			
--	---	--	--	--

Console Blackout

	<p>Sets a 'console black-out' for this snapshot.</p>	<p>The blackout turns off all console lights except for two that will deactivate the blackout.</p>		<p style="text-align: right;">Active</p> <p>Activate Blackout for this cue</p>
---	--	--	--	---

GPO On

	<p>Enable the GPO trigger functionality of this cue.</p>			<p style="text-align: right;">Active</p> <p>GPO Enabled for this cue</p>
---	--	--	--	---

GPO Virtual Pin

	<p>Select a virtual pin as the the GPO assignment for this cue.</p>		<p style="text-align: right;">Range Low</p> <p style="text-align: center;">0</p>	<p style="text-align: right;">Range High</p> <p style="text-align: center;">80</p>
---	---	--	---	---



GPO Physical Pin

	<p>Displays the physical pin number that corresponds to the selected virtual pin.</p>			
---	---	--	--	--

HiQNet Venue Number

	<p>Select a HiQNet Venue Number</p>		<p>0</p>	<p>100</p>
---	-------------------------------------	--	----------	------------

HiQNet On/Off

	<p>Enable HiQNet functionality for this Cue</p>			
--	---	--	--	--

14.4: Snapshot Filtering

Global Filter, Snapshot ISO, Show ISO



Snapshot filtering is a way of preventing certain settings on the console from changing when a Cue is recalled. There are two different reasons why this is useful, and therefore there are two different types of snapshot filtering: Global Filtering (also called Isolation), and Snapshot Scope.

Global Filtering only affects recall and is controlled with the console's [ISO] buttons or via the Global Edit mode; it stays on the desk when set and applies to ALL Cues that are recalled.

Snapshot Scope can be used to create partial snapshots; it is a specific filter that is stored with each Cue, and controls what data that Cue's desk snapshot will recall.

The Global Filter (or ISO) and the Snapshot Scope work together in series, so in order for a parameter to be recalled from the Snapshot memory, it must have its Scope setting set to ON, and must NOT be isolated. Scope defaults to 'all' for snapshots, so you can ignore it unless you specifically want to filter a snapshot.



14.4.1: Snapshot Scope



It can be very useful to make a Cue which, when it is recalled, only affects a specific area of the console - a 'Partial' snapshot. For example, you could make cues that will only set the Gains and EQ of all the channels, but leave the fader values unchanged.

There are two approaches to changing the scope of a cue. With (SHOW SCOPE) active, you will see selectable process/section blocks for input and output channels shown in the touch screen area, and a graphic of console channels shown in the VST area. Both can be used to set a specific scope for the cue.

Note that Scope is actually a non-destructive filter stored with the cue - the full snapshot is always stored and can be either restored or further limited by changing the cue's scope settings at any time.

Scope settings are done on a per cue basis, but whatever settings are showing will be used when the next cues is created.

Show/Hide Scope

	<p>Show or Hide the scope settings in the touch screen and VST areas.</p>	<p>Scope defaults to include all desk parameters, so you can hide scope and ignore it if you do not wish to use it.</p>		
--	---	---	--	--

Select All/None Process blocks

	<p>Select or deselect ALL process blocks to be within the scope of this cue.</p>			
--	--	--	--	--



Block Select

	<p>Select or deselect individual process blocks from the scope of this cue.</p>			
---	---	--	--	--

**Channel Scope
- Select All**

	<p>Select all channels to be within the scope of this cue.</p>			
---	--	--	--	--

**Channel Scope
- Select None**

	<p>Deselect all channels from the scope of this cue.</p>			
--	--	--	--	--

14.4.2: Global Filter - Snapshot & Show Isolation

To get manual control back while in a sequence of cues - either of a whole channel, groups of channels, or an element within a channel, you can use Global Filtering. The console [ISO] buttons are the main tools for this. Once a parameter is isolated, that parameter will remain under manual control regardless of which desk snapshot is recalled – hence the term Global filter; however, controls that are isolated can still be stored, so you can update snapshots with the manually adjusted changes at any time.

To isolate channels, busses, or parts of channels and busses you can use either the [ISO] button, or put the whole desk into Global Edit mode.

The Global edit filter (LOAD ISO WITH SHOW) can also be used to isolate aspects of the console’s set-up from entire Show loads. So for example, if you have an engineer who brings a pre-configured show file to a shared console at a festival, you can isolate the console’s output settings, which would normally be configured specifically for the venue, and protect them from being over-written by the new Show file.

The Global Edit button puts the whole desk into Edit mode so you don’t have to hold the [ISO] button.

Isolate [ISO]

	<p>Select channels, groups of channels, and parameter blocks, and individual parameters to be part of the Global Filter.</p>	<p>To quickly Isolate a whole channel or bus from the snapshot recall, press its [ISO] button. The channel strip border on the Vistonics screen changes to purple to indicate the 'All Isolated' state. To quickly isolate groups of channels or busses, the Gang function can be used.</p> <p>To isolate parts of a channel or buss you can use either the [ISO] button, or put the whole desk into Global Edit mode.</p> <p>With an [ISO] button held, simultaneously touch the part of the channel strip that you want to isolate, in the touch screen. A purple LED appears in the top corner of the block to indicate that the block is isolated. To isolate an individual parameter, touch the Vistonics controls for the parameters you want to isolate. You can either zoom into the function block before selection, so the parameters within that block are already mapped onto the VST area, or touch and hold a screen block as well as the [ISO] button - that will zoom into the parameters for the block.</p>
--	--	--

Global Filter Enable

Active

	<p>Activate Global Filter</p>	<p>With the Global Filter activated, 'ISO' selected channels and parameters will be isolated from snapshot recall.</p>		<p>Global Filtering Enabled</p>
---	-------------------------------	--	--	---------------------------------

Global Filter Edit Mode

Inactive

Active

	<p>Activate Global Edit mode.</p>	<p>All desk parameters are available for adding to the Global Filter, without having to hold down an [ISO] button.</p>	<p>Normal Operation</p>	<p>Mode enabled</p>
---	-----------------------------------	--	-------------------------	---------------------

Load ISO With Show

Active

	<p>Enable or disable Global Filter for Show loading.</p>	<p>When set to YES the console ISO settings will be cleared and overwritten by loading a new Show file. Set this to NO to protect isolated sections of the console from being overwritten by a new Show file.</p>		<p>Show Filtering Enabled</p>
---	--	---	--	-------------------------------

Talkback & Oscillator



Most main oscillator and talkback controls are grouped together in the master bay, though there is a Talkback Assignment button [TB ASSN] in the VISTONICS button group, which allows manual assignment of the talkback group buss destinations.

Talkback is an independent signal path, normally from a microphone input to group and physical outputs, activated with push-to-talk talkback buttons on the console itself. It is most often used to allow the console operator to talk to assistants, performers, and so on. There is also a talkback return, which is an independent input path to the monitor section - most often used to allow assistants and performers to talk directly to the console operator.

The oscillator is a signal generator provided as a general-purpose calibration and checking tool.



15.1: Talkback And Oscillator Controls



Talkback And Oscillator Set-up

Active

	Open and close the Talkback and Oscillator setup screen in the master Vistonics screen.			Open Setup Screen
--	---	--	--	-------------------

Talkback XLR Connector

	The Talkback Mic input.	There is a switch for phantom power adjacent to the Talkback Mic connector if required.		
--	-------------------------	---	--	--

Talkback / OSC Level Control

	Control of Talkback or Oscillator level.	For Talkback, the analogue Mic Amp gain is variable from 46-66dB by an internal variable preset which is located on the pcb that is located inside on the base of the console. This is set by default to a mid-range setting. If the Oscillator is active, the control adjusts the Osc level to all destinations. The level setting is stored independently for TB and Osc.		
--	--	---	--	--

Talkback To Internal

Active

	Route the Talkback signal to pre-selected output busses.	The 'INT' routed Output busses are selected via their {TB} VST keys in the VST area of the master screen after selecting the [TB ASSN] key (located to the right of the master screen's VST area). Switch between the two sets of 16 busses with the [PAGE A] and [PAGE B] keys.		Sends Talkback signal to pre-selected Aux/Group/Matrix Busses
--	--	--	--	---



Talkback to External

Active

	<p>Route the TB signal to the TB OUT external balanced analogue line output on the rear of the console (default), or to any other available output.</p>	<p>Change the EXT TB assignment via the Talkback/Oscillator SETUP screen.</p>		<p>Routing Active</p>
---	---	---	--	---------------------------

Talkback Presets 1-3

Active

	<p>Press-to-talk (momentary and latching), user-programmable Talkback switches.</p>	<p>Select the output routing for the Talkback presets via the Talkback/Oscillator SETUP screen.</p>		<p>Routing Active</p>
---	---	---	--	---------------------------



15.2: Oscillator Setup & Use



The main oscillator controls appear in the master bay touch screen area when the Oscillator / Talkback [SETUP] button is pressed. More detailed setup functions appear in the VST area, colour-coded orange.

The oscillator can also be patched to the Input Channels by using the {OSC} key in the Input Channel VST screen.

Pink Noise

	<p>Set the oscillator waveform to pink noise.</p>			
---	---	--	--	--

White Noise

	<p>Set the oscillator waveform to white noise.</p>			
---	--	--	--	--

Sine Wave

	<p>Set the oscillator waveform to sine.</p>			
---	---	--	--	--

Oscillator To Bus

	<p>Feed the Oscillator signal to the preconfigured Busses.</p>	<p>OSC To Bus assignments are selected in the Bus Assign page via the Talkback/Oscillator SETUP screen.</p>		
---	--	---	--	--

Oscillator To Talkback

	<p>Route the oscillator signal to the TB Bus (replaces the TB signal).</p>			
---	--	--	--	--

Oscillator Frequency

		Range Low	Range High
	<p>Adjust the Oscillator sinewave Frequency in the range 20Hz to 20kHz.</p>	20Hz	20kHz

Oscillator Bus Assignment

		In Active	Active
	<p>Used in conjunction with the Oscillator to Bus touchscreen switch.</p>	<p>Closes assignment screen</p>	<p>Opens assignment screen</p>

Oscillator On

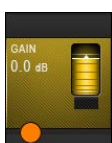
		In Active	Active
	<p>Activate the console's oscillator.</p>	Off	On

Oscillator Gain

		Range Low	Range High
	<p>Adjust the oscillator output level</p>	-infinity	+18dB

Oscillator Output

		In Active	Active
	<p>Assign the oscillator to individual physical outputs.</p>	<p>Closes patch screen</p>	<p>Opens patch screen</p>



15.3: Talkback Setup & Use



Talkback is a communications path between the console operators and the artists, crew, and other personnel. There is a direct-plug mic input (XLR) on the console surface with the TALKBACK/OSC group of controls. This and other talkback routing and configuration options are detailed below.

Talkback Source

			Active	Inactive
	Select the Talkback source / input.	If (NONE) is selected the console's TB mic XLR is automatically selected. The button opens up an assignment selection page in the master touch screen area where you can select any available microphone input.	Close source selection screen	Open source selection screen

Talkback External Output

			Active	Inactive
	Assign the Talkback output directly to individual physical console outputs.	Opens an output assignment page with all available physical outputs.	Close patching screen	Open patching screen

Talkback Pre-set Assignment

			Active	Inactive
	Assign a selection of output busses to the selected Talkback preset		Close assignment screen	Open assignment screen



15.4: Talkback Return Setup & Use



Talkback return allows the console operator to route inputs directly into the monitor circuit. This allows assistants within a venue to talk directly to the console operator. The talkback function must be enabled via the MONITORING setup page by selecting the TB RET touchscreen button for Monitor A, B or Phones outputs.

Talkback Return ON

		Inactive	Active
	Enable the Talkback return.	Disabled	Enabled

Talkback Return Gain

		Range Low	Range High
	Adjust the Gain of the talkback return input.	-90dB	+12dB

Talkback Return Assignment

		Inactive	Active
	Assign the Talkback Return input.	Opens an input assignment page with all available physical inputs.	Opens an input assignment page with all available physical inputs.



MAIN MENU & SETTINGS



The Main Menu contains settings for general console systems and functionality, including GPIO and MIDI setup; Show loading duplicating, and export/import; Tielines (input > output patching) setup, Lexicon FX operation, and more...

Menu Button

Active

	<p>Access the main menu.</p>	<p>The main menu will appear on the master bay touch screen. Navigate the menu by selecting the various tabs. Some tabs map additional controls to the VST area.</p>		<p>Main Menu Active</p>
---	------------------------------	--	--	-----------------------------



Menu: Main



This menu tab is displayed by default whenever the [MENU] button is pressed.

Brightness

	<p>Choose the brightness level for all screens, illuminated keys, and FaderGlow.</p>			
--	--	--	--	--

Desk Lock

	<p>Lock all switches, encoders, and faders on the console, except for the [LOCK] key.</p>			
--	---	--	--	--



Menu: Shows

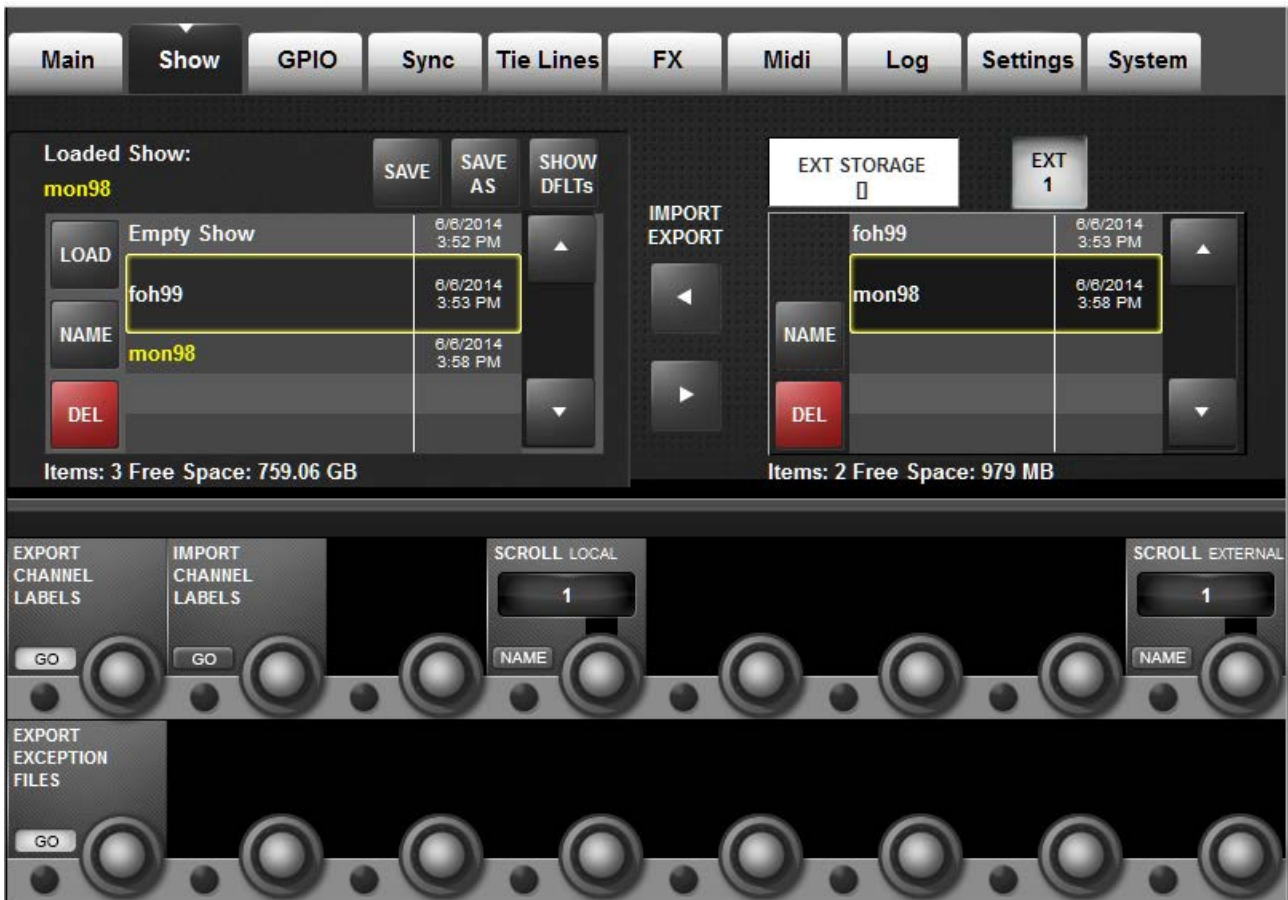

Shows are the main vehicle for storing console control settings, cue lists and snapshots, and audio set-up.

Loading Shows, copying Shows to and from USB data storage devices, and creating new Shows is done from the Show tab in the Main Menu.

The left-hand side of the page displays the shows that are present on the console's hard drive. If there are any USB storage devices connected, these will be selectable and displayed on the right hand side of the page. Normally the front panel USB Data Socket will be used (USB1), but it is possible to connect USB data storage devices to the rear panel USB sockets (USB2 and USB3), and select the required device with the (USB1), (USB2), and (USB3) buttons. The up and down-arrows on both Show file lists are used to scroll through the available Show titles.

The user can select a default show or another existing show and use the (SAVE) and (SAVE AS) keys as required.

IMPORTANT: If you want to base your Show on one of the defaults, you MUST save it as a new show before you start working, otherwise you will not be able to store Snapshots. This is because of the write-protection assigned to the default Shows.



Load Show

	<p>Load the selected show from the hard drive.</p>	<p>Shows can only be loaded from the internal hard drive, they must be imported from the external storage first.</p>		
---	--	--	--	--

NAME

	<p>Rename the selected Show file.</p>	<p>Opens up the text entry screen.</p>		
---	---------------------------------------	--	--	--

Delete Show

	<p>Delete the selected Show file.</p>	<p>An additional screen will appear asking you to confirm the deletion or cancel it.</p>		
--	---------------------------------------	--	--	--

Save

	<p>Update the loaded Show file.</p>	<p>A confirmation dialogue will appear.</p>		
---	-------------------------------------	---	--	--

Save As

	<p>Save all current show parameters as a new Show.</p>	<p>You will be prompted to input a new show name via the on-screen keyboard or an external USB keyboard.</p>		
---	--	--	--	--

Show Defaults

	<p>Display the default Shows in the Show file list.</p>	<p>The console comes with some factory-installed shows. These are not normally visible in the list, but they can be seen by pressing the (SHOW DFLT) button. The default Shows are at the top of the list and are shown in italic text. They cannot be deleted with the (DEL) key, nor renamed. If you want to base your Show on one of the defaults, you MUST save it as a new show before you start working, otherwise you will not be able to store Snapshots. This is because of the write-protection assigned to the default Shows.</p>		
---	---	--	--	--



Scroll Local Shows

	<p>Scroll through the local (internal) show file list.</p>			
---	--	--	--	--

USB Import / Export

	<p>Exporting A Show TO, or import a show FROM A USB Data Storage Device.</p>	<p>Pressing the right-facing arrow will export the currently-selected Show to an installed USB data storage device. Pressing the left facing arrow will import the selected USB-stored show to the console's internal storage. Note that the date and time of the latest save is shown in both lists.</p>		
---	--	---	--	--

Export Channel Labels

	<p>Choose to export channel labels with a Show export.</p>			
--	--	--	--	--

Import Channel Labels

	<p>Choose to import channel labels with a Show export.</p>			
---	--	--	--	--

Scroll External Files

	<p>Scroll through the external (selected USB storage) show file list.</p>			
---	---	--	--	--

Export Exception Files

	<p>Exports log files that are generated if the console software restarts unexpectedly. For use under instruction of Soundcraft service personnel.</p>	<p>The files are saved in a folder called 'Exceptions' on the USB stick, and should be zipped and emailed to Soundcraft support when requested.</p>		
---	---	---	--	--



Menu: Shows - Show File Recorded Data

Menu: Shows - Recorded Data

Some settings are recorded as part of a Show, others as part of a Snapshot, and a few are not recorded at all.

Please note that in addition to the snapshots in the cue list, a Show has one 'Show Snapshot'. This Show Snapshot is generated automatically, and it cannot be seen by the user. It holds the Cue List, the Show Settings and Audio Settings. These three sets of data contain all of the parameters that change when a Show is loaded.

The Show Snapshot's Audio Settings contains all the settings which a standard Snapshot can store; as a result, the Show Snapshot can be thought of as the last settings before the Show was unloaded (Assuming you choose to save the existing show before loading a new one). The Show Snapshot allows the complete status of the console to be recorded with the Show, even if no Snapshots have been saved.

Settings Recorded Within A Show Snapshot's Show Settings.

- Monitoring Settings: Monitor Level; Phones Volume; Solo Trims; Solo Blend; Monitor A/B Switch Status; Monitor On/Off Switch Status; Monitor Source Selection Status; Monitor Setup states.
- All switches in Talkback section.
- Talkback Settings: Talkback Levels; Talkback setup.
- Generator Settings: OSC Level, Type.
- Mute Safe Status (Input & Output).
- System Preferences: Current Sample Rate, Dante/MADI source switch, Dante clock mode.
- Automation Setup States.
- VCA / MG Assign View switches status: Currently selected view.
- Bus Config States: Bus Formats; Bus Types and Bus Labels.
- Channel Pairing States: Stereo Channel pairings.
- HiQnet Setup.
- MIDI Configuration Setup: MIDI Channel names.
- ISO switch status (Input & Output).
- O/P Vistonics Lock Mtr switch status.
- O/P Vistonics Solo/OnOff/TB switches.
- All parameters in the Menu/Settings page.
- Follow Solo switches.



Settings Recorded Within Audio Settings.

This applies to the Show Snapshot and to any standard Snapshots.

- All Channel audio settings on the console: Channel ON; Fader positions; Pan; Channel Parameters (EQ, Dynamics, input/output, insert).
- All Channel Bus assigns, levels, Pre/Post states and Channel Labels.
- All Channel Patch ordering.
- All I/O routing.
- All I/O controls.

Settings Not Recorded

- PFL/SOLO switch status.
- SEL Switch status.
- LRC Sel switch status.
- Metering values.
- All round Setup switch status.
- User Defined switches (O/P fdr pnl) status.
- All switches in Snapshot Control section.
- Power On switch status.
- Copy/Paste/Undo switch status.
- Set Pre/Post modes switch status.
- Pan/Level toggle switch status.
- Gang Mode switch status.
- Solo Clear switch status.



Menu: GPIO



You can configure all available GPIO channels in the GPIO (General Purpose Input Output) tab of the main menu. However, please note that 'virtual' GPIO pins can also be assigned to cues in the cue list via the Snapshot SETUP page. Virtual GPIO Pins are assigned via the function/parameter setting in the main GPIO settings.

The GPIO card (not included with console as standard but available as an optional expansion card and fitted as standard to Stageboxes) provides electrically isolated opto-coupler inputs with integrated current sink (5 to 24 VDC) and electrically isolated outputs using SPST relay contacts. 5 VDC and Gnd supply pins are provided. Inputs and outputs are on standard D-type connectors (female).

If a GPIO card is fitted, or a Stagebox is attached, the main screen shows a list of available GPIO connection 'pins' on the selected hardware (console or stage box). The upper section shown in blue is the GPI (input) section, and the lower section shown in red is the GPO (output) section. Each entry shows its various configurations across several columns; these are set in the VST section of the master bay Viconics.



Console GPIO Select

	<p>Selects the GPIO in the control surface (16 GPIO channels).</p>	<p>No function unless optional GPIO option card is fitted to either of the two expansion slots.</p>		
---	--	---	--	--

Stagebox GPIO Select

	<p>Selects the GPIO in the Stage Box (8 GPIO).</p>	<p>(no function unless one or more Stageboxes attached)</p>		
---	--	---	--	--

GPIO Up / Down List

	<p>Scroll though the GPI and GPO lists</p>	<p>The currently-selected input and output channels are outlined in yellow.</p>		
--	--	---	--	--

GPI On / off

	<p>Enable and disable GPI functionality</p>	<p>Individual setting for each Pin.</p>		
---	---	---	--	--

Function Select

	<p>Select the function to be assigned to the GPI pin.</p>	<p>Depending on the function selection, the {Parameter} field may or may not be available. For example, the Channel Mute (CH MUTE) function requires a channel assignment - set using the {parameter} field; the NEXT CUE function does not require any additional parameter</p> <p>Available functions: Channel Mute (CH MUTE); (F KEY LED); Talkback Input (TB INPUT); Dim Monitors (DIM MON); VIRTUAL GPI; LAST CUE; NEXT CUE; CUE UP; CUE DOWN; RECALL CUE; Undo Snapshot (UNDO SNAP).</p>		
---	---	--	--	--

Parameter Set

	<p>Used to assign additional values to functions</p>	<p>Certain GPIO functions require and additional parameter. Examples are channel number, virtual GPIO pin number, and so on.</p>		
---	--	--	--	--



Trigger Edge Select

	<p>Choose the triggered edge for this GPI pin.</p>	<p>Choose either Rising, Falling, or Both. If you choose 'Both' the {Polarity} field will become available.</p>		
---	--	---	--	--

Trigger Polarity Select

	<p>Set the Polarity of the input.</p>	<p>The encoder changes the polarity between positive and negative. This field is only available if the {EDGE} field is set to BOTH.</p>		
---	---------------------------------------	---	--	--

GPO On / off

	<p>Enable and disable GPO functionality</p>	<p>Individual setting for each Pin.</p>		
---	---	---	--	--

GPO Function

	<p>Select the function to be assigned to the GPO pin.</p>	<p>Depending on the function selection, the {Parameter} field may or may not be available. For example, the Fader Start (FDR START) function requires a channel assignment - set this using the {Parameter} field; the Talkback Output (TB OUTPUT) function does not require any additional parameter.</p> <p>Available functions: Channel Mute Fader Start (FDR START); F KEY; Talkback Output (TB OUTPUT); VIRTUAL GPO; Channel Mute (CH MUTE).</p>		
---	---	---	--	--

GPO Parameter

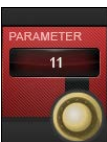
	<p>Used to assign additional values to functions where required.</p>	<p>Examples include channel number, virtual GPIO pin number, and so on.</p>		
---	--	---	--	--

Pulse Time

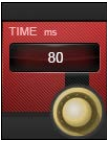
	<p>Set the Relay Pulse Time.</p>	<p>The relay contacts will revert to their original position at the end of the pulse time. The encoder adjusts the pulse length in ms (a blank field means no pulse is generated - the relay contacts stay in their new position). It is suggested that a pulse time is set only when the EDGE field is set to 'RISING' or 'FALLING'. It is also suggested that no pulse time is set when the EDGE field is set to 'BOTH'.</p>		
---	----------------------------------	--	--	--

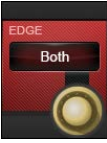

Edge Select

	<p>Choose the triggered edge for this GPO pin.</p>	<p>Choose either Rising, Falling, or Both. If you choose 'Both' the {Polarity} field will become available.</p>		
---	--	---	--	--

Polarity Select

	<p>Set the Polarity of the output.</p>	<p>The encoder changes the polarity between positive and negative. This field is only available if the {EDGE} field is set to BOTH.</p>		
---	--	---	--	--



Menu: SYNC



The settings in this tab determine the digital audio clock configuration for the console

Internal Clock

	<p>Internal sync selected. (NB: not a control)</p>	<p>The console runs at 48kHz internal clock only.</p>		
---	--	---	--	--

External Clock

	<p>External clock source selected (NB: not a control)</p>	<p>The console switches to External Wordclock automatically if a valid 48kHz wordclock signal is received at the rear panel BNC Wordclock In connector, or Dante Sync mode is set to Master. A green LED adjacent to the Wordclock In BNC socket indicates a valid lock to external clock. In order for the console to lock to the external clock its frequency must be 48kHz +/-100ppm.</p>		
---	---	--	--	--



**Dante Sync:
Master**

Active

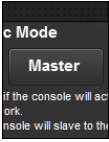
 <p>The screenshot shows a menu titled 'Dante Sync Mode' with a 'Master' button highlighted. Below the button, it says 'if the console will act as master for the Dante network, the console will slave to the selected master.' There is also a 'Slave' button visible below.</p>	<p>Switch console sync to Dante Master mode.</p>	<p>When 'Master' button is selected, console is forced to switch to EXT sync, and console then slaves to Dante network clock (requires correct setting of network sync within external Dante Controller software).</p>		<p>Dante Master mode activated.</p>
---	--	--	--	-------------------------------------

**Dante Sync:
Slave**

Active

 <p>The screenshot shows a menu titled 'Dante Sync Mode' with a 'Slave' button highlighted. Below the button, it says 'Use Slave mode (Default) for the Dante network. Use Master mode if the console is to act as master for the Dante network.' There is also a 'Master' button visible above.</p>	<p>Switch console sync to Dante Slave mode.</p>	<p>When 'Slave' button is selected, console runs on internal clock and the Dante network is synced to the console internal clock (requires correct setting of network sync within external Dante Controller software).</p>		<p>Dante Slave mode activated.</p>
---	---	--	--	------------------------------------



Menu: TIELINES



TIE Lines are direct connections from an input connector to a output connector. They are a path through the mixer with no processing and no mixing, and there they do not use up any DSP channels. The console supports up to 24 tie lines, arranged 8 per page.

Page Select

	<p>Switch between three pages of 24 possible Tie Line patches.</p>			
--	--	--	--	--



Tieline Input Patch

Active

	<p>Assign a physical input to this Tie Line.</p>	<p>The Red INPUT buttons open an input assign page in the main touch screen area where you can choose any available console input.</p>		<p>Input Patch Screen</p>
---	--	--	--	---------------------------

Tieline Output Patch

Active

	<p>Assign a physical output to this Tie Line.</p>	<p>The Red OUT buttons open an output assign page in the main touch screen area where you can choose any available console output.</p>		<p>Output Patch Screen</p>
---	---	--	--	----------------------------

Tieline Label

Active

	<p>Define a custom label for the Tie Line.</p>	<p>The Tie Line Label buttons open up a text entry screen in the main touch screen. You can also use an external USB keyboard.</p>		<p>Text Entry Screen</p>
--	--	--	--	--------------------------



Menu: FX



This is where you configure the four internal FX processors. Please see the Effects chapter of this reference for more specific information.

Lexicon FX Engine 'n'

			Active
	<p>Select a Lexicon FX processor to control</p>	<p>Algorithm selection and related parameters are mapped to the VST section of the Master Bay Vistonics screen. works in parallel with any FX processing icon found within a channel or bus processing strip. Most importantly, this page shows an overview of where each FX unit has been assigned, using the input/output or insert patching screens of the relevant channel/bus.</p>	<p>FX Edit</p>



MENU: MIDI



General MIDI setup for the console

List RX Channels

	<p>Display the MIDI input channels in the device list.</p>	<p>The Device List allows you to specify friendly names for each MIDI channel or Device ID, to help with identifying a source or destination device in other MIDI setup screens such as the MIDI Events list in the Cue List.</p>		
--	--	---	--	--

List TX Channels

	<p>Display the MIDI output channels in the device list.</p>	<p>The Device List allows you to specify friendly names for each MIDI channel or Device ID, to help with identifying a source or destination device in other MIDI setup screens such as the MIDI Events list in the Cue List.</p>		
--	---	---	--	--



List TX Devices

	<p>Display the MIDI output Device IDs in the device list.</p>	<p>The Device List allows you to specify friendly names for each MIDI channel or Device ID, to help with identifying a source or destination device in other MIDI setup screens such as the MIDI Events list in the Cue List.</p>		
---	---	---	--	--

MIDI Device Name

	<p>MIDI Device Name display</p>	<p>Allows the friendly name to be entered using on-screen QWERTY keyboard.</p>		
---	---------------------------------	--	--	--

Scroll MIDI Device List

	<p>Fast-Scroll through the device list with the encoder.</p>			
--	--	--	--	--

MIDI In Enable/Disable

		Active	Inactive
	<p>Enable / Disable All MIDI input activity.</p>	<p>Disable MIDI In</p>	<p>Enable MIDI In</p>

Global MIDI Input Channel

	<p>Set the Global MIDI input channel</p>			
---	--	--	--	--

Global MIDI Input Device ID

	<p>Set the Global MIDI input Device ID</p>			
---	--	--	--	--



**MIDI Timecode
Enable**

			Inactive	Active
	Enable MIDI Timecode Input		Timecode Disabled	Timecode Enabled

**MIDI Timecode
Frame Rate**

	Sets desired frame rate in FPS for outgoing timecode events and incoming timecode.	When enabled, the Show name displayed in the Master Bay touchscreen is replaced by the timecode display.		
---	--	--	--	--

**Timecode
Display On/Off**

	Enable or disable the timecode display in the Master Bay touchscreen area.			
--	--	--	--	--

**MIDI Out
Enable/Disable**

			Inactive	Active
	Enable / Disable All MIDI output activity.		Disable MIDI Out	Enable MIDI Out

**Global MIDI
Output Channel**

	Set the Global MIDI output channel			
---	------------------------------------	--	--	--



MENU: LOG



This page displays any errors that have occurred since the console was last powered-up. These would usually be communications errors between the various components in the system such as control surface, local rack, and stagebox.

The most recent message is also displayed at the top right of the master section's main screen, in the Error Log Display Area. The message is cleared from the main screen after the Log page has been viewed by the user. Note that the Log page can be reached as described above, or by touching the Error Log Display Area on the main screen.

Error Expand/ Compact

	<p>Expand or compact the selected error message.</p>	<p>Expanded error messages wrap the text so the whole error message can be viewed, at the expense of the number of errors viewable at the same time.</p>		
--	--	--	--	--



Automatic Scrolling

	<p>Cause the most recent message to be displayed as the currently-selected one</p>			
---	--	--	--	--

Clear Log

	<p>Clear the error log list.</p>			
---	----------------------------------	--	--	--



MENU: SETTINGS



Miscellaneous settings for the console, including the date and time, plus input meter source point and general meter peak hold time, delay, EQ, graphic EQ, and Dante / MADI source selection.

Set Date And Time

Active

	<p>Map console date and time settings controls to the VST section of the Master Bay Viconics panel.</p>			<p>Date And Time settings</p>
--	---	--	--	-------------------------------

Meter Peak Hold Set

Range Low

Range High

	<p>Adjust the console metering Peak Hold time from 0 to 12 Seconds.</p>		<p>0 Secs</p>	<p>12 Secs</p>
--	---	--	---------------	----------------



Set Meter In Point

	<p>Determine the metering point for the input channel level meters.</p>	<p>There are four choices for the input meter tap, from left to right: After the analogue mic gain (before digital trim and filters); after the digital trim and filters (before the Gate/EQ/Dynamics); after the Gate/EQ/Dynamics (before the fader); after the fader.</p>		
---	---	---	--	--

Graphic EQ Large/Small Mode

			Range Low	Range High
	<p>Choose between Large and Small Graphic EQ control modes.</p>	<p>Choose 'Large' 30-fader mode for fast access on multiple faders, at the expense of access to the input faders, or choose 'Small' (eight output faders) mode when access to input faders must be retained at all times. Frequency bands can be scrolled in banks of four or eight bands, using the Output Fader page buttons.</p>	Small GEQ	Large GEQ

Set Delay Units

	<p>Change the units used in input, output, and monitoring delay adjustments.</p>	<p>You can choose between milliseconds, metres, or feet and inches.</p>		
--	--	---	--	--

EQ bandwidth units

			Range Low	Range High
	<p>Choose the the unit for bandwidth controls in the EQ sections throughout the console</p>	<p>Selected either Octaves or Q-factor (defined as the ratio of frequency to bandwidth). The direction of the control is reversed between the two settings: In Q mode, clockwise narrows bandwidth, in Octaves mode, clockwise widens bandwidth.</p>	Q-Factor	Octave Bandwidth

Enable NEXT and LAST

			Inactive	Active
	<p>Enable the [NEXT] and [LAST] cue list navigation buttons nearest the operator.</p>		[NEXT]/[LAST] at front of desk disabled	[NEXT]/[LAST] at front of desk enabled

DANTE / MADI Select

			Range Low	Range High
	<p>Switch MADI/Dante input between MADI and Dante sources.</p>	<p>See hardware reference 4.2 for operational details.</p>	Dante selected	MADI selected



MENU: SYSTEM

System Monitoring and HiQnet/VM² Setup



System monitoring and HiQnet setup.

In normal operation, the main System Monitoring Overview Display Area is located at the top right of the Master Bay touch screen, and the Error Log Display Area is just below it. Within the System Monitoring Overview Display Area each hardware device and the HiQnet™ network state is represented with a coloured label. The label colour indicates the overall state of the system monitoring page. A green label indicates that this device is running correctly, whereas a red label indicates an error condition.

Error and warnings are displayed in the Error Log Display Area.

To access detailed System information, enter either through the main menu by pressing [MENU] then (System), or by touching the System Monitoring Overview Display Area. When the System page has been opened, there are 4 sub-pages accessed via the touch-pads on the right hand side: DESK, LOCAL I/O, STAGE BOX and HiQnet™.



**Desk
Information**

	<p>Display the current status of the desk's 4 bays.</p>	<p>The numerical data displayed for each bay gives the revision number of the firmware currently installed in each bay. This information may be needed by Soundcraft service personnel if technical or service support is requested.</p>		
---	---	--	--	--

**StageBox
Information**

	<p>Display a graphical representation, and the current status, of the cards in the Stage Box.</p>	<p>This also shows the status of the PSU(s) and the status of the voltages for the analogue (VA) and digital (VD) power supply rails. The cooling fan status is also reported. A blue label under a card display indicates an input function, and a red label indicates an output function.</p> <p>If the card configuration of the Stagebox is changed (for example when AES input or output cards are fitted in place of the analogue cards), the card labels will be automatically updated with the new card types if the 'Reconfig' button on the Stagebox front panel has been pressed after changing the cards.</p>		
---	---	---	--	--

**VM² / HiQnet
Set-up**

	<p>Enter the VM² setup screen</p>	<p>VM² stands for 'Vistonics Microphone Monitoring'. It takes advantage of Harman's HiQnet control network to allow a level of integration between a HiQnet-enabled AKG Wireless Microphone system, and a Soundcraft Vi Series console.</p> <p>This section is also used to set up a network IP address for use with both ViSi Ipad remote control app, and the Soundcraft Realtime Rack host control for Universal Audio Plug-ins.</p> <p>Please see the HiQnet/VM² reference chapter 18 for more detail.</p>		
---	--	--	--	--



Lexicon FX

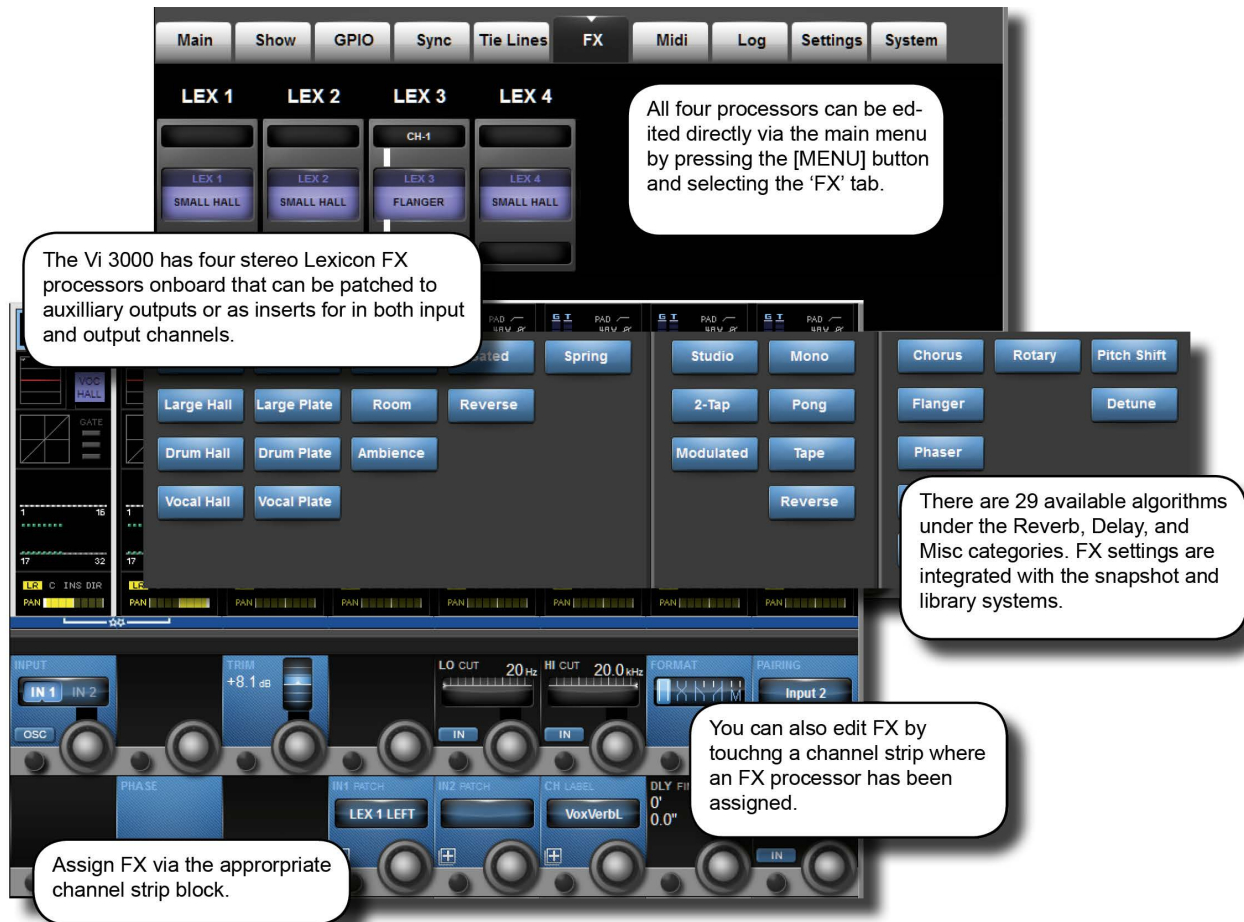

The Vi3000 comes with Lexicon FX processors. Each FX Unit can be inserted into any Output/Main Master bus or into any Input Channel, or it can be patched as an FX Return to an Input Channel or fed from an Aux send.

Each FX Unit supports up to 30 different professional LEXICON® Effects with algorithm and parameter adjustment integrated into the console's Vistonics II environment - editable either from the relevant channel's bay, or from the Master Bay via the FX Overview page in the main menu.

All Parameters from the four Effects Units and for all Effects Type are stored in the desk Snapshots.

LEXICON® Effects Format

Depending on the selected effect type, the FX processor works internally in one of three formats: Mono, Mono In/Stereo Out, or Stereo In/Stereo Out.

The FX processor always has Stereo Inputs and Outputs. If the FX Type needs only a Mono Input, the Left and Right Input Signal are summed together. If the FX Type outputs only a Mono Signal then the Output Signal is distributed to both the Left and Right Outputs. The MIX Parameter adjusts the ratio between the original (dry) signal and the effects (wet) signal. The stereo format of the dry signal will be maintained.



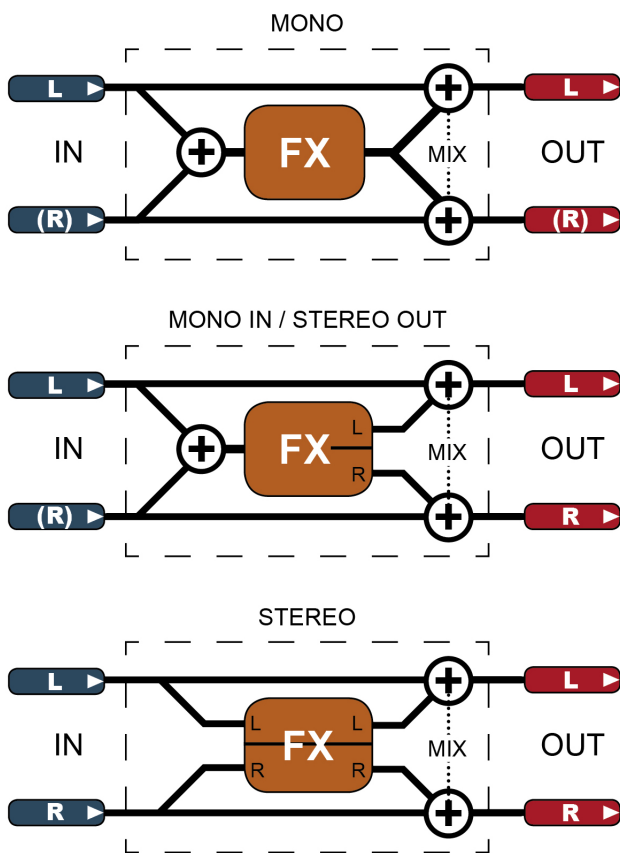

The Lexicon FX processors work in three different formats.

An FX processor always has stereo inputs and outputs. For a mono-input effect, the left and right input signals are summed together. For a mono output, the single output signal is distributed to both left and right outputs.

'MIX' represents the effect's own wet/dry mix parameter.

Using The Lexicon FX Processors

Each FX processor can be patched in three ways. Aux Masters can be patched to the inputs of FX units; input channel inputs can be patched to the outputs of FX units; and both input and output insert points can be patched to FX units.

Patching status is visible in the FX overview page, though actual patching of FX units takes place in the relevant source / destination channel strips. For example, to patch an FX unit to an input channel you would go to that input channel's channel strip (input block).

So, to use an FX unit in a traditional aux send / return setup you would patch an aux output to the inputs of an FX unit, then patch an input channel to the outputs of the same unit.

As well as the VST {tap tempo} button, the console's F-Keys can be assigned to the tap tempo function (see below for details).

As An Aux Send

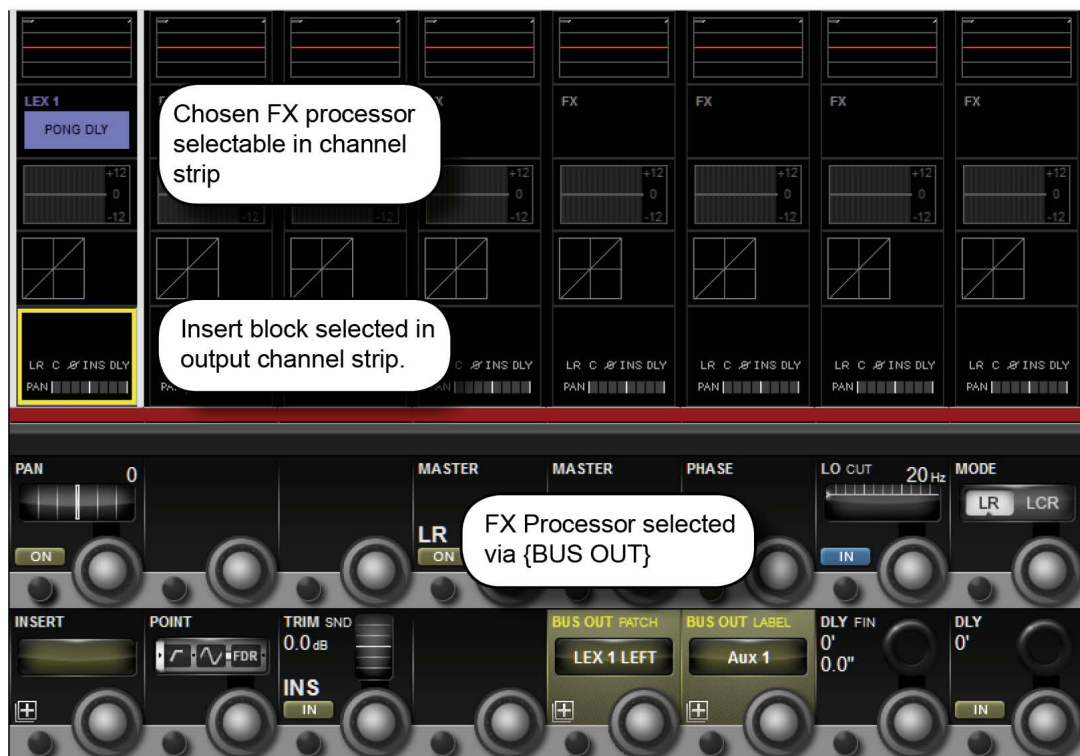

To patch an FX unit as an Aux send destination, you must first select either the output or the insert point of the chosen Aux master. A fast way to get to the aux channel strips is to press the [All BUSSES] button. See the Outputs reference chapter 7 for more options).

If you use the insert point of the aux bus you can then patch the output of that aux directly to the master LR bus, for example. Once assigned as an insert, you will be able to edit the select FX unit directly by touching the FX block in the output channel's touch screen channel strip.

If you patch the main output of the aux bus to the input of an FX unit, you then need to select an input to patch to the output of that FX unit.



Touch the Insert/output/delay block in the channel strip, then use the BUS OUT PATCH or INS PATCH options in the VST section to bring up the relevant patching options onto the touch screen. Simply select the Lexicon In page from the options on the right hand side of the touch screen and then select the required FX unit.

If you are patching the output of a stereo aux bus, then left and right buttons will appear in the patch screen. For normal routing you should assign each to the corresponding inputs of an FX unit.

As An FX Return

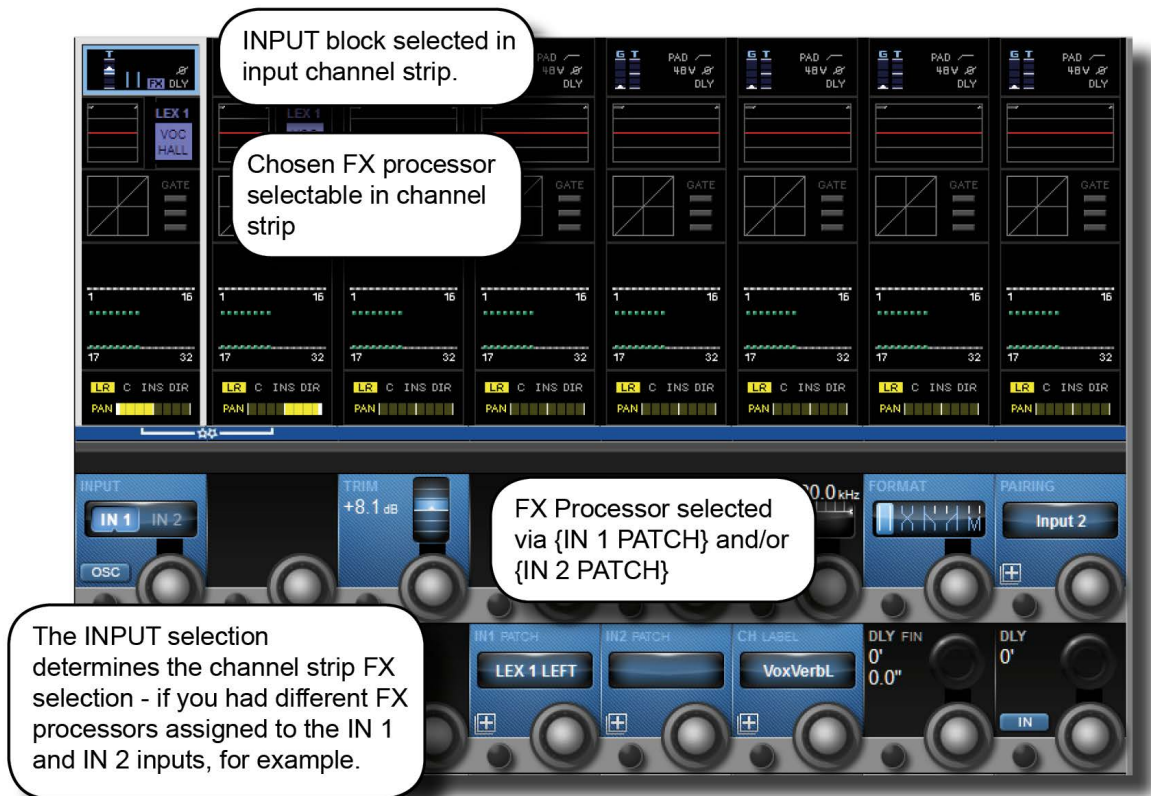

To patch an input channel as an FX return, select that input's input block from the top of the touch screen channel strip, then use either the {IN 1 PATCH} or {IN 2 PATCH} option to assign the output of an FX unit to that channel.



As An Insert

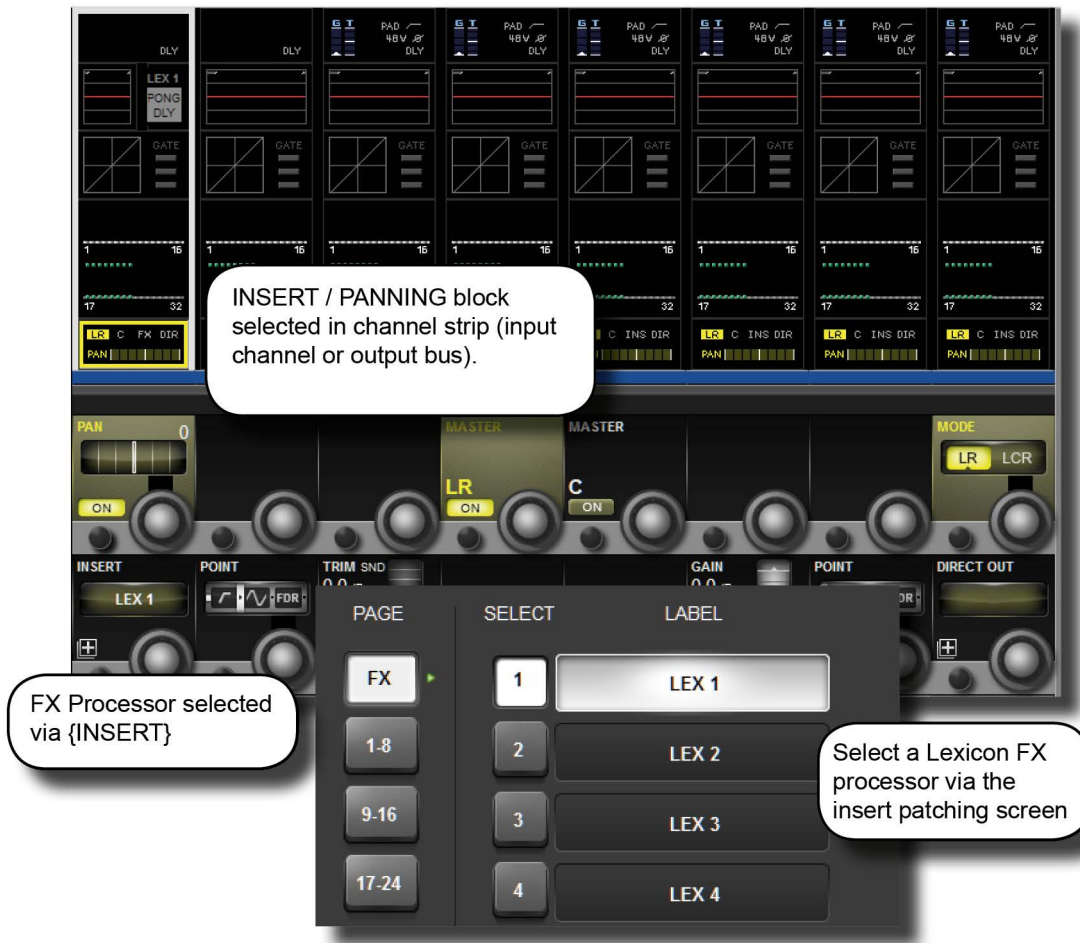

To patch an FX unit into the insert point of an input channel, select the Panning/Insert block from the bottom of the touch screen channel strip, then use the {INSERT} patch option to select an FX Unit. Touch the (FX) button on the top left of the touch screen to show the available FX selections.

Once assigned you will be able to edit the selected FX unit directly by touching the FX block in the input channel's touch screen channel strip.



Tap Tempo Functionality



For each effect that offers TAP Tempo (Tempo synchronisation using key press), the bottom left key {TEMPO} is used as the TAP button.

In live situations it is often advantageous to be able to easily control the TAP function from a large button which is permanently accessible on the console surface. The large F1-4 keys below the master screen are assigned by default on Vi3000 to the tap function of FX1-4, so no further setup is needed as long as shows are built from the Vi3000's internal default shows. However if you are importing a show from a Vi 4 or 6 console, only the first two of these F keys may be mapped to the tap function. The information that follows will allow any F key to be mapped to the tap function of any FX unit in the event that a Vi4 or 6 show is being used.

In order to assign the TAP functions of FX units to the F-keys, proceed as follows (refer to the screenshot above):

- . Press the [MENU] button and select the {GPIO} menu tab.
- . Ensure the {LOCAL I/O} button is selected and scroll the input and output sections down to the VGPI and VGPO Pin settings. For LEX3, select VGPI Lex Tap3 and VGPO Lex Tap3.
- . Set the parameters for the VGPI and VGPO as shown in the above picture, and ensure the input and output are switched ON.

Use a similar procedure for other FX units.

FX Algorithms and Parameters

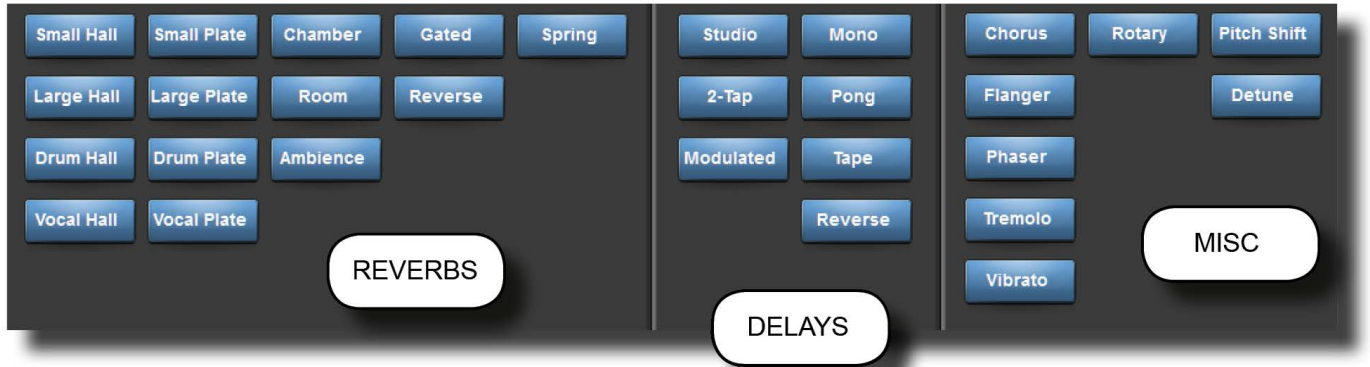

For each of the four FX processors an individual FX Type can be selected. The FX Types are grouped into the following categories: Reverb, Delay, and Miscellaneous. You can select algorithms by hitting the {TYPE} button in the VST section of any FX page.

Reverbs

Reverberation (or “reverb” for short) is the complex effect created by the way we perceive sound in an enclosed space. When sound waves encounter an object or boundary, they don't just stop. Some of the sound is absorbed by the object, but most of the sound is reflected or is diffused. In an enclosed space, reverb is dependent on many features of that space, including the size, shape and the type of materials that line the walls. Even with closed eyes, a listener can easily tell the difference between a cupboard, a locker room and a large auditorium. Reverb is a natural component of the acoustic experience, and most people feel that something is missing without it.

Halls

SMALL HALL, LARGE HALL, DRUM HALL, VOCAL HALL - Stereo

A Hall reverb is designed to emulate the acoustics of a concert hall – a space large enough to contain an orchestra and an audience. Because of the size and characteristics, Halls are the most natural-sounding reverbs, designed to remain “behind” the direct sound – adding ambience and space, but leaving the source unchanged. This effect has a relatively low initial echo density which builds up gradually over time.

Vocal Hall and Drum Hall reverbs are specifically tailored for those uses. Vocal Hall has a lower overall diffusion which works well with program material that has softer initial transients like a voice. Drum Hall has a higher diffusion setting which is necessary to smooth out faster transient signals found in drums and percussion instruments.

In addition to general instrumental and vocal applications, the Hall program is a good choice for giving separate tracks in a mix the sense of belonging to the same performance.

Plate Reverbs

SMALL PLATE, LARGE PLATE, DRUM PLATE, VOCAL PLATE - Stereo

A Plate reverb is a large, thin sheet of metal suspended upright under tension on springs. Transducers attached to the plate transmit a signal that makes the plate vibrate, causing sounds to appear to be occurring in a large, open space. The Plates in the Vi4 FX units model the sound of metal plates with high initial diffusion and a relatively bright, colored sound. Plate reverbs are designed to be heard as part of the music, mellowing and thickening the initial sound. Plate reverbs are often used to enhance popular music, particularly percussion.

Chamber Reverb

Stereo

Historically, recording studio chambers were oddly shaped rooms with a loudspeaker and set of microphones to collect ambience in various parts of the room. Chamber programs produce even, relatively dimensionless reverberation with little color change as sound decays. The initial diffusion is similar to the Hall programs. However, the sense of size and space is much less obvious. This characteristic, coupled with the low color of the decay tail, makes these programs useful on a wide range of material - especially the spoken voice, to which Chamber programs add a noticeable increase in loudness with low colour.



Room Reverb

Stereo

Room produces an excellent simulation of a very small room which is useful for dialogue and speech applications. Room is also practical when used judiciously for fattening up high energy signals like electric guitar amp recordings.
Plate Reverbs

SMALL PLATE, LARGE PLATE, DRUM PLATE, VOCAL PLATE - Stereo

Ambience Reverb

Stereo

Ambience is used to simulate the effect of a small or medium sized room without noticeable decay. It is often used for voice, guitar or percussion.

Spring Reverb

Mono In/Stereo Out

A Spring reverb is created by a pair of piezoelectric crystals—one acting as a speaker and the other acting as a microphone—connected by a simple set of springs. The characteristic ‘boing’ of a spring is an important component of many classic rock and rockabilly guitar sounds.

Reverse Reverb

Mono In/Stereo Out

Reverse reverb works in the opposite fashion from normal reverb. Whereas a normal reverb has the loudest series of reflections heard first that then become quieter over time, the Reverse reverb has the softest reflections (essentially the tail of the reverb) heard first, and then grows louder over time until they abruptly cut off.

Spring Reverb

Mono In/Stereo Out

A Spring reverb is created by a pair of piezoelectric crystals—one acting as a speaker and the other acting as a microphone—connected by a simple set of springs. The characteristic ‘boing’ of a spring is an important component of many classic rock and rockabilly guitar sounds.



Reverb Parameters

Pre Delay

			Range Low	Range High
	Adjust time delay between the source signal and the onset of reverberation.	This control is not intended to precisely mimic the time delays in natural spaces, as the build-up of reverberation is gradual, and the initial time gap is usually relatively short. For the most natural effect, the Pre Delay values should be set in the range of 10-25 milliseconds. However, if a mix is very busy or overly cluttered, increasing the Pre Delay time may help clarify it, and set each instrument apart from each other.	0mS	100 / 200mS

Reverb Time

	Adjust the amount of time the reverb can be heard.	Higher settings increase reverberation times which are usually associated with larger acoustical environments, but can decrease intelligibility. Lower settings shorten reverb times and should be used when a smaller apparent space or a more subtle effect is desired.	Dependant on algorithm.	Dependant on algorithm.
---	--	---	-------------------------	-------------------------

Size

	Build-up rate of diffusion after the initial period (which is controlled by Diffusion).	The Size control changes reverb sound from very large to very small. Generally, set this control to the approximate size of the acoustic space being created, before adjusting anything else. The size in meters is roughly equal to the longest dimension of the space. Audio is temporarily muted when Size is changed.	Dependant on algorithm.	Dependant on algorithm.
---	---	---	-------------------------	-------------------------

Diffusion

	Initial echo density.	High settings of Diffusion result in high initial echo density, and low settings cause low initial density. In a real-world situation, irregular walls cause high diffusion, while large flat walls cause low diffusion. For drums and percussion, try using higher Diffusion settings.	Dependant on algorithm.	Dependant on algorithm.
---	-----------------------	---	-------------------------	-------------------------

Shape

	Adjust the 'contour' of the reverberation envelope.	With Shape all the way down, reverberation builds explosively, and decays quickly. As Shape is advanced, reverberation builds up more slowly and sustains for the time set by Spread. With Shape in the middle, the build-up and sustain of the reverberation envelope emulates a large concert hall (assuming that Spread is at least halfway up, and that Size is 30 meters or larger).	Dependant on algorithm.	Dependant on algorithm.
---	---	---	-------------------------	-------------------------



Spread

	<p>Adjust reverb onset and sustain.</p>	<p>Low Spread settings result in a rapid onset of reverberation at the beginning of the envelope, with little or no sustain. Higher settings spread out both the build-up and sustain.</p>	<p>Dependant on algorithm.</p>	<p>Dependant on algorithm.</p>
---	---	--	--------------------------------	--------------------------------

Reverb High Cut

			Range Low	Range High
	<p>Set the frequency of a 6dB/octave low-pass filter on the reverberated signal.</p>	<p>It does not attenuate the reflections. High frequencies are often rolled off with this parameter, resulting in more natural-sounding reverberation. Setting a low frequency for this parameter can actually shorten the reverb time, as it damps the audio as it recirculates.</p>	<p>1kHz</p>	<p>20kHz</p>

High Cut

			Range Low	Range High
	<p>Adjust the amount of high frequency content in the reverberation tails.</p>	<p>Higher frequency settings increase high frequency response, creating brighter reverbs; lower frequency settings create darker reverbs with more bass frequency emphasis.</p>	<p>1kHz</p>	<p>20kHz</p>

Bass Boost Frequency

			Range Low	Range High
	<p>Set the frequency at which the transition from Mid Rt to Low Rt takes place</p>	<p>This control should be set at least two octaves higher than the low frequency you want to boost. For example, to boost a signal at 100Hz, set Bass Boost Frequency to 400Hz. (This setting works well for classical music.) Crossover works best around 400Hz for boosting low frequencies, and around 1.5 kHz for cutting low frequencies.</p>	<p>100Hz</p>	<p>2kHz</p>

Bass Boost Ratio

			Range Low	Range High
	<p>Boost or cut frequencies below the Bass Boost Frequency.</p>	<p>The amount of boost or cut required is highly dependent on the material being processed.</p>	<p>0.2</p>	<p>4</p>

Early Reflection Time

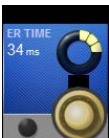
			Range Low	Range High
	<p>Adjust the amount of time before reverb early reflections occur.</p>		<p>1mS</p>	<p>150mS</p>



Early Reflections Level

	<p>Adjust the level of early reflections within the reverb.</p>		<p>0</p>	<p>99</p>
---	---	--	----------	-----------

Feedback Delay

Range Low

Range High

	<p>Change the resonant frequencies of Plate reverb.</p>		<p>1mS</p>	<p>150mS</p>
---	---	--	------------	--------------

Feedback Level

Range Low

Range High

	<p>Adjust a Plate reverb's presence and prominence.</p>		<p>-99</p>	<p>+99</p>
--	---	--	------------	------------

Boing

	<p>Increase or decrease the 'spring rattle' in a spring reverb.</p>	<p>This is a physical characteristic of spring tank reverbs.</p>	<p>0</p>	<p>99</p>
---	---	--	----------	-----------



DELAYS

Delays repeat a sound a short time after it first occurs. Delay becomes echo when the output is fed back into the input (feedback). This turns a single repeat into a series of repeats, each a little softer than the last.

Studio Delay

Stereo

The Studio Delay features up to 1 second of stereo delay and offers a built-in ducker that attenuates the delay output whenever signal is present at the input. This can be used to keep the original signal from being muddled up by delay repeats.

2-Tap Delay

Stereo

The 2-Tap Delay is probably best described as an adjustable pong delay where each tap can be individually set in relation to the delay time. The 2 taps are a calculated percentage of the actual delay time from 1-100% (for example, if the delay time is 500ms and Tap 1 is set to 50% and Tap 2 is set to 100%, Tap 1 time would be 250ms and Tap 2 time would be 500ms). Narrow spacing of the tap percentages can widen the stereo image of the delay while wider tap spacing can create rhythmic delay lines.

Modulated Delay

Stereo

The Modulated Delay is enhanced by an LFO (low frequency oscillator) that produces a chorusing effect on the delay repeats. This is a great delay for guitar and instrument passages that need that “special something.”

Mono Delay

Mono In/Stereo Out

The Mono Delay is the cleanest, most accurate of the delay programs, with up to 1 second of mono delay with panned output, and the built-in ducking feature.

Pong Delay

Mono In/Stereo Out

This delay effect pans the delay repeats from left to right, while the input signal remains at its original(center) position.



Tape Delay

Mono In/Stereo Out





In the days before digital, delays were created using a special tape recorder in which the magnetic recording tape was looped, with closely-spaced recording and playback heads. The delay effect was created by the tape moving in the space between the record and playback heads – while delay time was adjusted by changing the speed of the tape loop. Although very musical-sounding, wow and flutter combined with a significant loss of high frequencies, and to some extent also low frequencies, are all elements commonly associated with tape recordings.

Reverse Delay

Mono In/Stereo Out

This delay effect emulates the old studio trick of flipping a tape over, playing it backwards through a tape delay, and recording the effect. The delays “build up” from softer to louder – creating the sensation that the delays come before the signal.

Delay Parameters

Tempo		Range Low	Range High
	Enter the 'Tempo' Time.	This time is expressed as tempo in BPM (beats per minute). Tempo works in conjunction with Delay Time to set the actual delay time that is heard.	Infinity 24 BPM
Tap Tempo			
	Enter the Tempo time by tapping.	Repeatedly tap the {TAP} button to automatically set the delay tempo. The console 'F' keys 1-4 are assigned to the delay tap tempo.	
Delay Time			
	Controls the length of the delay time relative to Tempo.	At the middle of its range, delay repeats are synchronous with the Tempo button; lower values create faster repeats, while higher values increase the time between repeats.	Dependant on algorithm Dependant on algorithm
Delay Type		Range Low	Range High
	Choose between Tape and Digital delay types.	2-Tap Delay algorithm only.	DIGITAL TAPE



Tap Ratio

Range Low **Range High**

	<p>Controls the Tap ratio of left and right outputs relative to the Delay time.</p>	<p>Specific to the Pong Delay effect, this controls the delay time offset between left and right taps, expressed as a ratio of left to right time difference. In the centre the taps have the same time (1:1).</p>	<p>1:12</p>	<p>12:1</p>
---	---	--	-------------	-------------

Tap Swap

Range Low **Range High**

	<p>Swaps the delay time tap offset set by the Tap Ratio.</p>	<p>Specific to the Pong Delay effect - reverses the offset set by the Tap Ratio control.</p>	<p>L > R</p>	<p>R > L</p>
---	--	--	-----------------	-----------------

Delay Feedback

	<p>Controls the number of delay repeats by feeding the delay output signal back into the delay input.</p>	<p>This creates a series of delay repeats, each slightly attenuated until they become inaudible. Higher settings create more repeats; lower settings reduce the number of repeats. When this knob is turned fully clockwise, it engages Repeat Hold – delay repeats play back in an infinite loop, but no further input signal is introduced into the delay effect. Repeat Hold is available only on Studio, Mono and Pong Delay.</p>		
--	---	---	--	--

Low Cut Filter Frequency

Range Low **Range High**

	<p>Frequencies below this level are attenuated.</p>		<p>Off > 20Hz</p>	<p>20kHz</p>
---	---	--	----------------------	--------------

High Cut Filter Frequency

	<p>Frequencies above this level are attenuated.</p>		<p>20Hz</p>	<p>20kHz<Off</p>
---	---	--	-------------	---------------------

Smear

	<p>Ducking attenuation amount.</p>	<p>Available only for Tape and Reverse Delays, this parameter controls the amount of “smear,” or signal degradation and frequency loss. The higher the setting, the more each delay repeat loses intelligibility compared to the original signal.</p>	<p>0</p>	<p>99</p>
---	------------------------------------	---	----------	-----------



Ducker Threshold

Range Low Range High

	<p>Set the input signal level at which ducking occurs.</p>	<p>Studio, Mono and Pong delays only. Ducking causes delay repeats to be attenuated by a variable amount when an input signal is present. As the performance pauses, the delay signal level returns to its normal setting. This allows the delay to remain as an effect, but not clash with the original signal. For example whilst a vocalist is singing, the level of delay is kept down, but in the pauses the level of the repeats is brought up to provide a smooth tail to the vocal phrases. The Ducker Threshold sets the level at which the input signal has to be at for ducking to cut in – the higher the threshold, the louder the signal has to be for ducking to occur.</p>	<p>-70dB</p>	<p>0dB</p>
---	--	--	--------------	------------

Ducker Level

Range Low Range High

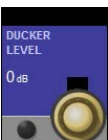
	<p>Ducking attenuation amount.</p>	<p>Ducker Level sets the amount of attenuation once the signal has exceeded the threshold. 0dB is no ducking, 18dB is the maximum amount of ducking to the delayed signal.</p>	<p>-18dB</p>	<p>0dB</p>
---	------------------------------------	--	--------------	------------

TAP 1 & 2

	<p>Tap delay time relative to displayed delay time value.</p>	<p>2-Tap Delay only. Sets the percentage of the indicated delay time that is used for each tap.</p>	<p>0</p>	<p>100%</p>
---	---	---	----------	-------------

Tap Level

	<p>Adjusts the output level of Tap 1 and Tap 2.</p>		<p>0</p>	<p>99</p>
---	---	--	----------	-----------

Tap Pan

Range Low Range High

	<p>Adjust the pan positions in the stereo field of Tap 1 and Tap 2.</p>		<p>99L</p>	<p>99R</p>
---	---	--	------------	------------

Modulation Depth

	<p>Control the intensity of modulation, or “depth” in the Modulated Delay.</p>	<p>Lower settings produce a more subtle chorus effect, while higher values give a more lush chorusing of the delay repeats.</p>	<p>0</p>	<p>99</p>
---	--	---	----------	-----------



Miscellaneous FX

The MISC category provides primarily modulated and pitch-varying effects.

Chorus

Stereo

Chorus creates a lush, full sound by combining two or more signals together where one is unaffected and the other signals vary in pitch very slightly over time. Chorus is commonly used to fatten up tracks and to add body to guitars without coloring the original tone. Chorus can also be used with discretion to thicken a vocal track.

Flanger

Stereo

This effect was originally created by simultaneously recording and playing back two identical programs on two tape recorders, then using hand pressure against the flange of the tape reels to slow down first one machine, then the other. The result was a series of changing phase cancellations and reinforcements, with characteristic swishing, tunneling, and fading sounds.

Phaser

Stereo

The Phaser automatically moves frequency notches up and down the spectrum of the signal by means of a low frequency oscillator (LFO), creating an oscillating “comb filter” type effect. This effect is very useful on keyboards (especially pad presets) and guitars.

Tremolo

Stereo (Wet Only)

Tremolo/Pan creates rhythmic changes in signal amplitude. Tremolo is obtained by setting Phase to 0 degrees, and affects both channels' amplitude simultaneously. If the Phase is set to 180 degrees, an AutoPanner effect is generated, with the amplitude of one channel being raised whilst that of the other channel is lowered. Speed settings below 1Hz are recommended in this case.

Vibrato

Stereo (Wet Only)

Vibrato is obtained by smoothly varying the pitch of the signal just sharp and flat of the original at a determined rate. Phase controls whether the pitch of both channels is modulated together, or in an opposite direction.



Rotary

Mono In/Stereo Out (Wet Only)

Rotary speaker cabinets were designed to provide a majestic vibrato/choir effect for electronic theater and church organs. The most well known rotary speaker is the Leslie™ Model 122, which has two counterrotating elements: a high-frequency horn and a low-frequency rotor with slow and fast speeds. The sound generated as the spinning elements change speed is truly magical. The swirling, spacious effect is difficult to describe – but clearly recognizable.

The Rotary effect is modeled after a Leslie-style cabinet. The input signal is split into high and low-frequency bands. The rotation effect is created by a synchronized combination of pitch shifting, tremolo, and panning. Like the physical cabinet, the high (horn) and low (rotor) frequencies are “spun” in opposite directions. Horn and rotor speeds are independent, and designed with acceleration and deceleration characteristics to simulate the inertia of the original mechanical elements. A virtual necessity for organ music, Rotary also sounds remarkable with guitar and electric piano rhythm parts. In fact, this program is a great alternative to the Chorus and Tremolo effects for any sound source.

Pitch Shift

Stereo

This effect shifts the frequency spectrum of the input signal. Altering the pitch of a sound produces a wide range effects - from subtle detunes to full interval shifts up or down a two octave range. The Pitch Shift effect is a chromatic shifter, meaning all notes of the scale are shifted by the same interval. Pitch Shift is very useful with guitar tracks, monophonic synth lines, or where special vocal effects are needed.

Detune

Stereo

Detune adds a slightly pitch-shifted version of the original source, thickening the sound. This creates a particularly effective simulation of “double-tracking.” This effect is also a great alternative to the Chorus effect, adding the richness of a chorus without the audible sweep caused by the chorus rate. It is also useful for creating a wide stereo signal from a mono source, by setting a small detune amount up on one output and down on the other, and panning the two outputs hard left and right.

Misc FX Parameters

Speed

Range Low

Range High

	<p>Sets the speed at which the modulated effect cycles.</p>		<p>0.05Hz</p>	<p>16Hz</p>
---	---	--	---------------	-------------

LFO Depth

	<p>Scales the intensity of the effect.</p>	<p>This control affects the output of the LFO only. It has no effect on the outputs of the individual waveforms.</p>	<p>0</p>	<p>99</p>
---	--	--	----------	-----------

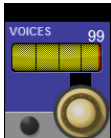

Number Of Voices

	<p>Controls the number of additional Chorus voices.</p>	<p>Higher amounts add more richness to the Chorus effect.</p>	<p>0</p>	<p>99</p>
---	---	---	----------	-----------

Regeneration

			Range Low	Range High
	<p>Controls the amount of modulated signal being fed back into the input, creating feedback.</p>	<p>Higher amounts add more resonance to the signal.</p>	<p>-99</p>	<p>+99</p>

Diffusion

	<p>Creates a time-smoothing effect similar to diffusion in reverb.</p>	<p>Diffusion can be a subtle effect to add a little warmth to the chorus.</p>	<p>0</p>	<p>99</p>
--	--	---	----------	-----------

Pre Delay

			Range Low	Range High
	<p>Determines the amount of offset between the two signals that create the flange effect.</p>	<p>Lower values create a tighter effect, higher values result in a more extreme “whooshing” sound.</p>	<p>0mS</p>	<p>20mS</p>

LFO Waveform

	<p>Selects the wave pattern used by the modulated effect.</p>	<p>Select from sine wave, triangle wave, and random.</p>		
---	---	--	--	--

Phase

			Range Low	Range High
	<p>Controls whether amplitude or depth change occurs in both left and right outputs simultaneously or alternates between left and right outputs.</p>		<p>0 Degrees</p>	<p>180 Degrees</p>



Phase Stages

	<p>Selects between a 4-, 8-, or 12-state phase shifter.</p>			
---	---	--	--	--

Horn Min

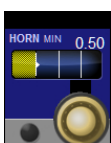
	<p>Rotary effect only: Minimum speed of the HF rotary horn.</p>	<p>The speed limits are used when the speed parameter is changed from Slow to Fast.</p>	<p>0</p>	<p>8</p>
---	---	---	----------	----------

Horn Max

		Range Low	Range High
	<p>Rotary effect only: maximum speed of the HF rotary horn</p>	<p>The speed limits are used when the speed parameter is changed from Slow to Fast</p>	<p>0.05 8</p>

Stereo Spread

	<p>Increases or decreases the stereo imaging of the Rotary effect.</p>		<p>0</p>	<p>99</p>
---	--	--	----------	-----------

Overdrive Gain

	<p>Adjust overdrive gain to the preamp section of the rotary speaker effect.</p>		<p>0</p>	<p>99</p>
---	--	--	----------	-----------

Minimum Rotor Speed

	<p>Sets the minimum speed at which the LF Speaker will rotate.</p>	<p>Rotary effect only: The speed limits are used when the speed parameter is changed from Slow to Fast</p>	<p>0</p>	<p>8</p>
---	--	--	----------	----------



Maximum Rotor Speed

			Range Low	Range High
	Sets the maximum speed at which the LF speaker will rotate.	Rotary effect only: The speed limits are used when the speed parameter is changed from Slow to Fast	0.05	8

Doppler Effect

	Increases or decreases the Doppler pitch effect.	The Doppler effect is a rise and fall in pitch experienced by an observer when a sound source is moving towards or away from them, due to a compressed or expanded wavefront.	0	99
---	--	---	---	----

Pitch Shift

			Range Low	Range High
	Determines the amount of pitch shift or detune shift from the original signal source.	Works best with individual notes.	-24	+24

Shift Delay

			Range Low	Range High
	Sets the delay time before the pitch shift or detune effect is heard in the Pitch Shift and Detune effects.		0mS	1 Sec

Feedback

	Adjusts how much of the shifted signal is sent back through the delay line in Pitch Shift and Detune.	For creating cascading arpeggio-type effects.	0	99
---	---	---	---	----

Pan

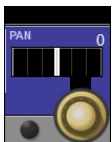
			Range Low	Range High
	Sets the pan position in the stereo field for each tap in the 2-Tap Delay or each channel of the pitch shift/detune effects.	Allows the stereo width to be increased by panning versions of the original signal that have been shifted slightly up and down, to left and right channels respectively.	99L	99R

VM² - Wireless System Monitoring

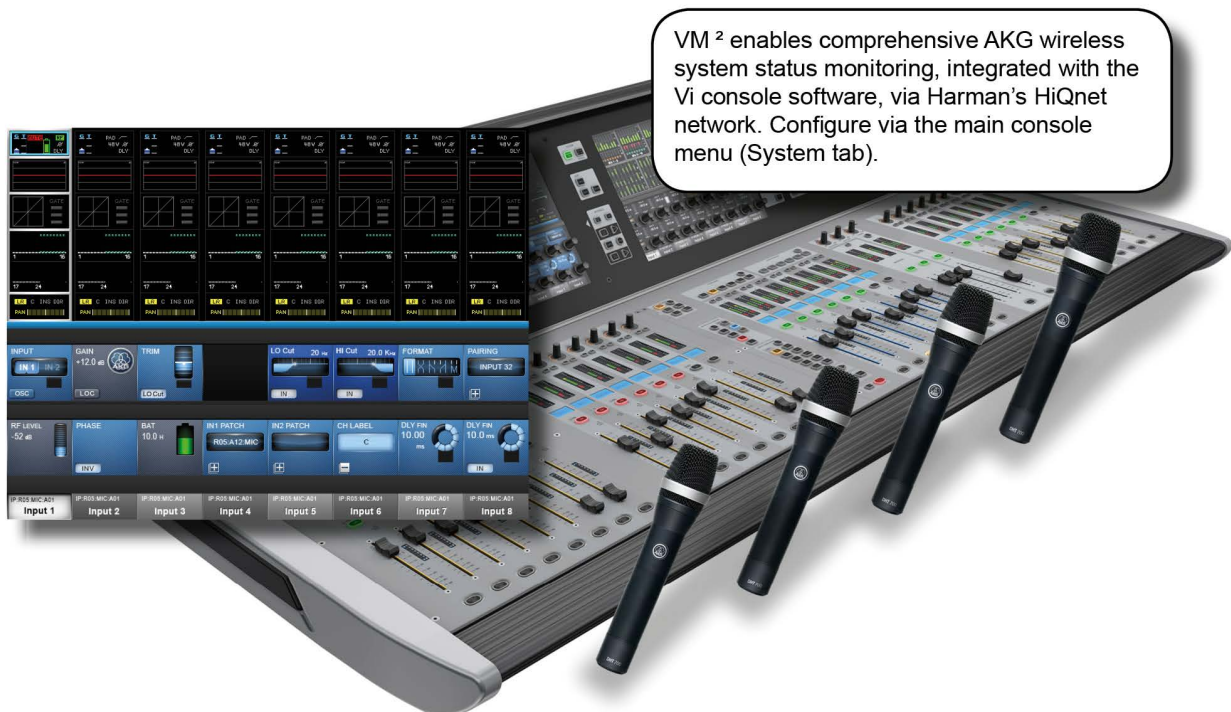

VM² is a patented feature that allows the status information for HiQnet-enabled AKG Wireless Microphone systems to be displayed directly within the channel strip that they are connected to. This feature takes advantage of Harman's HiQnet network control protocol and brings many benefits including streamlining of the workflow and increase in speed of problem diagnosis.

HiQnet-enabled AKG wireless receivers can be connected to the HiQnet network directly, via the AKG Hub4000Q (HiQnet merge device), from a shared network via an Ethernet Switch.

On the Vi3000, the HiQnet network setup is located in the main menu ([MENU]) under the (System) tab.

Available VM² status' are shown in the input channel's input block in the touchscreen, and in the VST section when that input block is selected. Also, the microphone names appear in the channel label display in the touch screen.

About HiQnet

HiQnet is a network communications protocol developed by Harman which enables various professional audio products within the Harman Pro-audio range to communicate with each other and provides remote control and monitoring of Harman devices such as power amplifiers, powered speakers, DSP processors and microphones. Ethernet is normally used as the transport method for HiQnet control, as it provides a robust and standardised method of connecting multiple devices in a network configuration. A Windows application called Audio Architect provides a master control and monitoring program that allows all equipment on the HiQnet network to be controlled from a single user interface.

On the Vi Series of consoles HiQnet allows error messages generated by other Harman devices to be displayed in the console's message log – for example thermal overload messages generated by Crown amplifiers. In addition the consoles are able to transmit a Venue Preset recall - the HiQnet equivalent of a MIDI Program Change – to all other devices in the network.



HiQnet Connector

	<p>The HiQnet port is an Ethernet connection on the rear of the control surface, adjacent to the rear USB sockets.</p>	<p>The port is capable of driving standard Ethernet distances of up to 100m.</p>		
---	--	--	--	--

Menu Button

	<p>The [MENU] button opens the console's main menu system in the Master Bay touch-screen area.</p>	<p>The console's HiQnet configuration can be accessed by pressing the main [MENU] button then the SYSTEM tab and HIQNET layer.</p>		
---	--	--	--	--

HiQnet Network Configuration

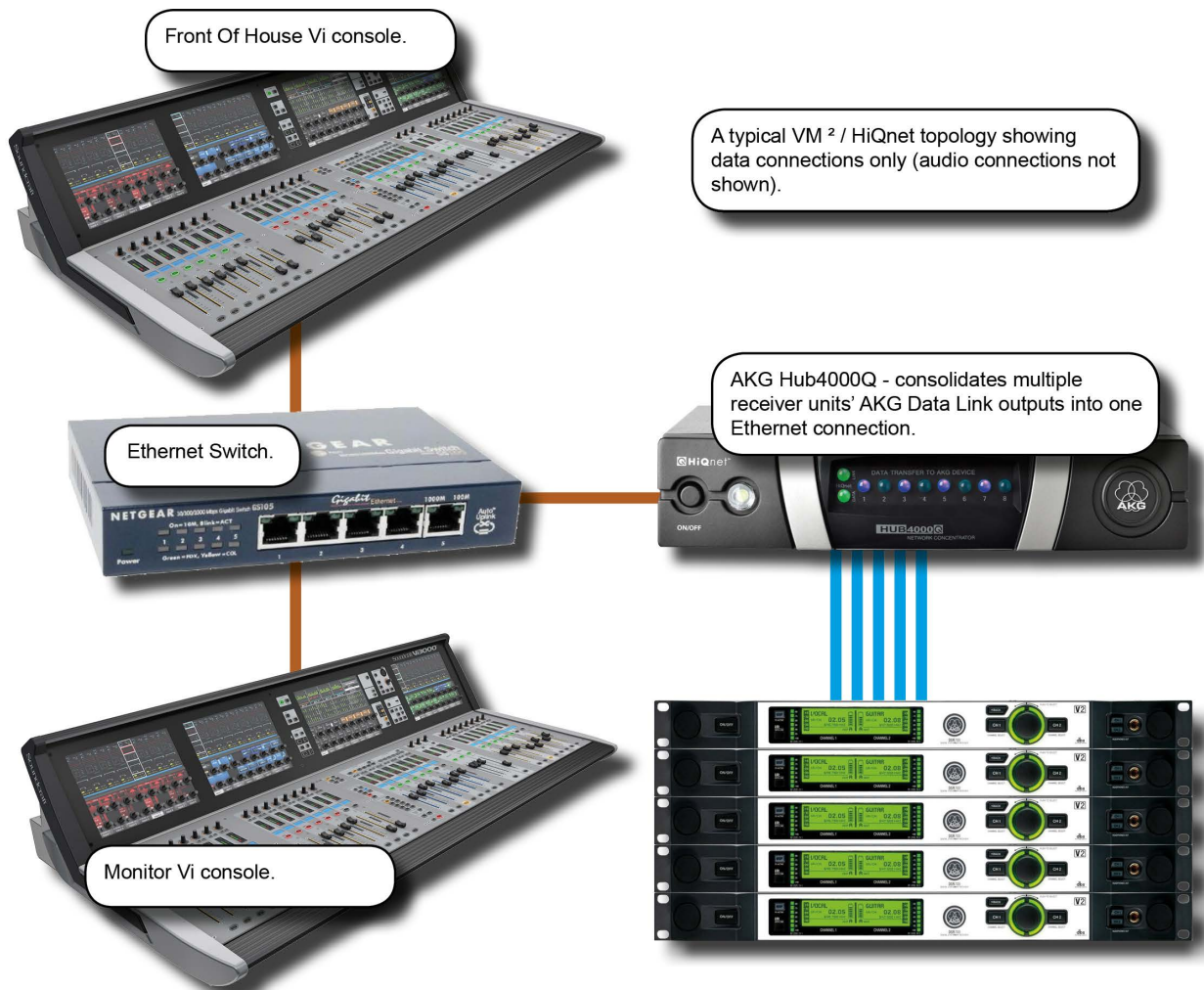

If only one console is being used, and there is no other HiQnet-connected equipment, the Hub4000Q can be directly connected to the console without using a switch, but in most cases it is better to use one. A computer running System Architect software may also be connected to the switch, and if a wireless router is included in the network, the AKG wireless iPhone app may be used for additional monitoring of the microphone data. The same wireless router or access point can be used to connect the ViSi Remote iPad app for remote control of the Vi3000 console.

Setup of the console involves basic network setup (console IP address and HiQnet Node Address) and assignment of detected devices to the physical inputs they are connected to.



**IP Configura-
tion**

			Range Low	Range High
	Select either Dynamic (DHCP) or Manual (MAN) IP configuration.	If you are using a DHCP server to automatically configure the IP setup, wait for several seconds until an IP address appears in the IP ADDRESS Vistonics control fields. You will also see it on the far left of the HiQnet page.	DHCP	Manual

**IP Address
Entry**

	Set IP address for the console.	For use with Manual (MAN) IP Configuration. Use the row of VST encoders to dial-in the required IP address for the console. The available ranges of valid IP addresses are 10.0.0.0 - 10.255.255.255; 172.16.0.0 - 172.31.255.255; 192.168.0.0 - 192.168.255.255. Some IP addresses within the ranges show are not allowed due to conflicts with other parts of the Vi system – they will be greyed out and not available for selection.		
---	---------------------------------	---	--	--

**Subnet Mask
Entry**

	Set the subnet mask.	For use with Manual (MAN) IP Configuration. Use the row of VST encoders to dial-in the subnet mask.		
---	----------------------	---	--	--

**HiQnet node
address entry**

				Active
	Set the console's HiQnet Node Address using the keyboard editor on the touchscreen.	The HiQnet node address can be any number in the range 1 – 65,535 but it must be a unique number within the network in order to avoid conflicts with other HPro devices. You can use Audio Architect to find out what the node addresses of other equipment are. Note that it will take up to 10 seconds for the new address to appear after the Enter button on the keyboard is pressed, and the console will be unresponsive during this time –this is normal.		Activate keyboard entry screen.

HiQnet On

			Inactive	Active
	Enable HiQnet functionality.	Once the IP address is set and the HiQnet node address has been confirmed as unique in the network, you can enable the HiQnet functionality by pressing the ON button in the far left Vistonics control. Enabling HiQnet will cause all the Vistonics controls in the section to change from greyed-out to orange. A list of information relating to the current HiQnet setup including a green 'OK' indicator is now displayed on the left side of the HiQnet Setup page, indicating a healthy connection.	HiQnet disabled	HiQnet Enabled



VM² Device List

DEVICE	NET	SOURCE
DSR700 #D1 CH1		
DSR700 #D1 CH2		
DSR700 #D2 CH1		
DSR700 #D2 CH2		

The Device list occupies the centre of the HiQnet Setup page, and will initially be completely empty. Once HiQnet has been turned on, and a HiQnet network is attached to the console, the console will search for any attached AKG microphones and display a list of the microphones found on the network in the left-hand column of the Device List.

Note: It may take up to 30 seconds to discover the mics.

The **DEVICE** column shows the names of all of the AKG microphones that have been discovered on the network. This column is automatically populated.

The **NET** column in the list shows the HiQnet node address of the AKG Hub4000Q to which each microphone is connected.

In the example shown above there is only one Hub4000Q connected, but it is possible for multiple Hub4000Qs to be connected to the network, and in this case the number in the NET column will enable groups of mics attached to these different Hubs to be distinguished from one another.

The **SOURCE** column in the list indicates the connector to which each microphone is associated. In order for the



console to know on which channel strip to display the VM² monitoring information, it is necessary to associate each of the microphone devices with a physical connector, which will correspond to the connector that the microphone's audio output is connected to.

The LOC button activates the Locate function on the selected AKG receiver. Pressing this will cause the front panel display of the chosen receiver to flash, allowing it to be more easily identified among a rack of others.

**MAP Devices
(Scroll List)**

	<p>Scroll through the list of available VM² devices.</p>	<p>Hint: To avoid opening and closing the Audio Patch page, the MAP DEVICES encoder can still be used to scroll through the Device List even whilst the Audio Patch page is still open. The name (truncated) of the currently selected Device can be seen in above the MAP DEVICES Vistonics scroll encoder.</p>		
---	---	--	--	--

Locate Devices

	<p>Activate the Locate function on the selected AKG receiver.</p>	<p>Pressing (LOC) will cause the front panel display of the chosen receiver to flash, allowing it to be more easily identified among a rack of others.</p>		
--	---	--	--	--

Patch Devices

Active

	<p>Activate the VM² microphone patching screen.</p>	<p>The patching matrix allows all of the physical input connectors available within the Vi system to be seen and the relevant connector to be chosen to correspond to where the currently selected microphone is connected. The chosen connector is shown in bright blue highlight, whereas connectors that are already associated with other AKG devices are shown as greyed-out. A greyed-out connector can still be chosen as an assignment for the currently selected microphone, but a dialogue box will appear in this case to ask if you wish to reassign this connector.</p>		<p>Patching Screen Active</p>
---	--	--	--	-------------------------------

Status Displays



The console displays VM² wireless system status information in two places - the main channel strip display in the input channel touch screen area (input block), and in the VST area when the channel's input block has been selected.



Channel Strip Status (Touch Screen Input Block)

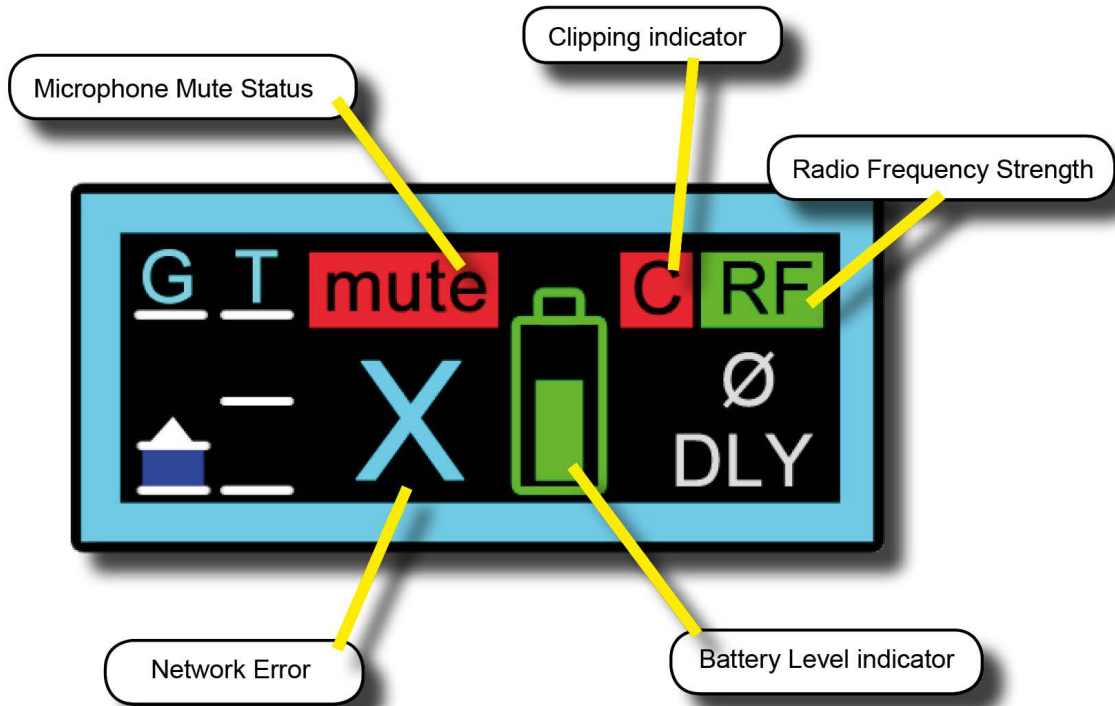

The input channel Input block graphic - shown at the top of the channel strip in the Vistonics touchscreen area - provides instant feedback on the status of VM² microphones via icons for each of the monitoring elements.

Microphone Muted

	<p>Shows microphone muted state.</p>	<p>Shows red 'MUTE' icon if the AKG mic is switched to muted state. When unmuted, this indicator icon disappears.</p>		
--	--------------------------------------	---	--	--

Microphone clipping

	<p>Clipping indication</p>	<p>A red 'C' is displayed momentarily if the audio within the wireless mic audio path reaches full scale.</p>		
--	----------------------------	---	--	--

RF Strength

	<p>Show the RF (Radio Frequency) status of the connected wireless microphone.</p>	<p>A red or green 'RF' icon is displayed to indicate the health of the AKG RF level. A green RF indicator is displayed when the signal strength at the receiver is strong enough to enable audio transmission. A red RF indicator is displayed when the signal strength is too low for audio transmission or if the transmitter is switched off. The actual value in dB of the RF signal strength is displayed in the VST section when the input block is selected.</p>		
---	---	---	--	--

Battery Level

	<p>Seven-segment transmitter battery level indication.</p>	<p>Red segments 0-1 indicate one hour or less remaining. The Amber segment (segment 2) indicates 25 percent of battery life remaining. The Green segments (segments 3-7) indicate 35-100 percent of battery life remaining. The number of hours remaining in the transmitter battery is displayed in the VTS section when the input block is selected and varies with the type of battery used.</p>		
---	--	---	--	--

Network Error

	<p>Indicates a Network error.</p>	<p>The system is able to differentiate between a network error/disconnection and out of range RF or a switched-off transmitter. In the case of a network error, the AKG elements only within the input strip overview on all channels will change to a greyed-out condition.</p>		
---	-----------------------------------	--	--	--

VM² VST Section Information



To see more detailed information about the AKG Microphones, the Input section of the channel strip can be zoomed by touching the Input touch field at the top of the strip. Three special Vistonics fields are added to the zoom view of channels that are patched to AKG-associated connectors, giving more detailed information of RF level (bargraph and numerical signal strength in dB), Battery level (bargraph icon plus numerical readout of remaining battery life in hours), and the internal gain of the microphone.

Note that this information is display-only, there is no control possible over the AKG microphones, other than with the Locate (LOC) button. Note also that the input gain control of the Vi microphone input preamp will be automatically set to 0dB gain and is not available for control on channels that have AKG microphones assigned.



Gain Display

	<p>Internal gain of the connected AKG microphone.</p>	<p>The display of internal Gain of the AKG microphone differs according to the type of microphone system being monitored. It cannot be controlled from the console. For WMS4500 systems the indicator displays the user-adjustable audio gain. For DMS700 systems the indicator shows the output trim level of the receiver.</p>		
---	---	--	--	--

Locate

	<p>Activate the Locate function on the selected AKG receiver.</p>	<p>Pressing this will cause the front panel display of the chosen receiver to flash, allowing it to be more easily identified among a rack of others.</p>		
---	---	---	--	--

RF Strength

	<p>Radio Frequency signal strength.</p>	<p>Shows signal level in bargraph and dB readout.</p>		
--	---	---	--	--

Battery Level

	<p>Remaining battery life as icon and numerical.</p>	<p>The remaining battery life numerical info in hours is only a guide, and depends on the type of cells used. The battery icon gives an accurate picture of the current state.</p>		
---	--	--	--	--