



PSM900

Wireless Personal Monitor System

Online user guide for PSM900 wireless personal monitor system.
Version: 9 (2020-C)

Table of Contents

PSM900 Wireless Personal Monitor System	3	Adding Transmitters to the CueMode List	20
IMPORTANT SAFETY INSTRUCTIONS	3	Auditioning Mixes	20
WARNING	4	Exiting CueMode	21
HEARING PRECAUTIONS	4	Managing CueMode Mixes	21
SAFETY PRECAUTIONS	4	Frequency Scan	21
WARNING	4	Sync	21
CAUTION	4	Downloading settings from the bodypack	22
General Description	4	Sending settings to the bodypack	22
Features	5	MixMode	22
Components	5	LOOP Applications	22
Quickstart Instructions	6	MixMode for Multiple Systems	22
Rack Mount Transmitter	6	Floor Monitors	22
Bodypack	8	Recording Devices	23
Scan and Sync	9	Squelch	23
Rack Unit Transmitter	11	Squelch Settings	23
Front Panel Controls	11	Point-to-Point Wireless Audio	23
Rear Panel Connectors	11	Specifications	24
Configuration Menu	12	Frequency Range and Transmitter Output Power	28
Bodypack Receiver	14	Furnished Accessories	29
Battery Life	15	Optional Accessories	29
Configuration Menu	16	Certifications	30
RF Settings	17	P9RA+	30
Audio Settings	17	P9T	30
Utilities and Display Settings	19	Australia Warning for Wireless	31
Multiple System Setup	19		
CueMode	20		

PSM900

Wireless Personal Monitor System

IMPORTANT SAFETY INSTRUCTIONS

1. READ these instructions.
2. KEEP these instructions.
3. HEED all warnings.
4. FOLLOW all instructions.
5. DO NOT use this apparatus near water.
6. CLEAN ONLY with dry cloth.
7. DO NOT block any ventilation openings. Allow sufficient distances for adequate ventilation and install in accordance with the manufacturer's instructions.
8. DO NOT install near any heat sources such as open flames, radiators, heat registers, stoves, or other apparatus (including amplifiers) that produce heat. Do not place any open flame sources on the product.
9. DO NOT defeat the safety purpose of the polarized or grounding type plug. A polarized plug has two blades with one wider than the other. A grounding type plug has two blades and a third grounding prong. The wider blade or the third prong are provided for your safety. If the provided plug does not fit into your outlet, consult an electrician for replacement of the obsolete outlet.
10. PROTECT the power cord from being walked on or pinched, particularly at plugs, convenience receptacles, and the point where they exit from the apparatus.
11. ONLY USE attachments/accessories specified by the manufacturer.
12. USE only with a cart, stand, tripod, bracket, or table specified by the manufacturer, or sold with the apparatus. When a cart is used, use caution when moving the cart/apparatus combination to avoid injury from tip-over.



13. UNPLUG this apparatus during lightning storms or when unused for long periods of time.
14. REFER all servicing to qualified service personnel. Servicing is required when the apparatus has been damaged in any way, such as power supply cord or plug is damaged, liquid has been spilled or objects have fallen into the apparatus, the apparatus has been exposed to rain or moisture, does not operate normally, or has been dropped.
15. DO NOT expose the apparatus to dripping and splashing. DO NOT put objects filled with liquids, such as vases, on the apparatus.
16. The MAINS plug or an appliance coupler shall remain readily operable.
17. The airborne noise of the Apparatus does not exceed 70dB (A).
18. Apparatus with CLASS I construction shall be connected to a MAINS socket outlet with a protective earthing connection.
19. To reduce the risk of fire or electric shock, do not expose this apparatus to rain or moisture.
20. Do not attempt to modify this product. Doing so could result in personal injury and/or product failure.
21. Operate this product within its specified operating temperature range.

WARNING

LISTENING TO AUDIO AT EXCESSIVE VOLUMES CAN CAUSE PERMANENT HEARING DAMAGE. USE AS LOW A VOLUME AS POSSIBLE. Over exposure to excessive sound levels can damage your ears resulting in permanent noise-induced hearing loss (NIHL). Please use the following guidelines established by the Occupational Safety Health Administration (OSHA) on maximum time exposure to sound pressure levels before hearing damage occurs.

90 dB SPL at 8 hours	95 dB SPL at 4 hours	100 dB SPL at 2 hours	105 dB SPL at 1 hour
110 dB SPL at ½ hour	115 dB SPL at 15 minutes	120 dB SPL Avoid or damage may occur	

HEARING PRECAUTIONS



To prevent possible hearing damage, do not listen at high volume levels for long periods.

SAFETY PRECAUTIONS

The possible results of incorrect use are marked by one of the two symbols—"WARNING" and "CAUTION"—depending on the imminence of the danger and the severity of the damage.

	WARNING: Ignoring these warnings may cause severe injury or death as a result of incorrect operation.
	CAUTION: Ignoring these cautions may cause moderate injury or property damage as a result of incorrect operation.

WARNING

- If water or other foreign objects enter the inside of the device, fire or electric shock may result.
- Do not attempt to modify this product. Doing so could result in personal injury and/or product failure.

WARNING: Battery packs shall not be exposed to excessive heat such as sunshine, fire, or the like.

CAUTION

- Never disassemble or modify the device, as failures may result.
- Do not subject to extreme force and do not pull on the cable or failures may result.
- Keep the product dry and avoid exposure to extreme temperatures and humidity.

General Description

The Shure PSM[®] 900 Wireless Personal Monitor System offers an unprecedented combination of superb audio quality, robust RF performance, and category-leading features for the most demanding professional applications. Patented Audio Reference

Companding and advanced digital signal processing technology provide excellent stereo separation and audio clarity. Exceptional transmitter linearity vastly reduces frequency intermodulation, allowing more channels per frequency band. Patented CueMode technology enables the sound engineer to monitor different stage mixes with the touch of a button.

Features

Unparalleled Audio Quality

- Bodypack receivers with advanced digital signal processing technology deliver more headroom, improved stereo separation, and higher audio fidelity.
- Patented Audio Reference Companding offers natural and transparent sound.
- Available with Shure SE425 Sound Isolating™ earphones featuring dual high-definition MicroDrivers for accurate and balanced audio response.

Robust RF Performance

- P9RA+ bodypack receivers offer enhanced signal reception and range.
- Precision front-end RF filtering significantly reduces RF interference for a cleaner, stronger RF signal, fewer dropouts, and fewer audible artifacts.
- Exceptional transmitter linearity vastly reduces frequency intermodulation and allows up to 20 compatible channels per frequency range.
- Automatic RF gain control prevents signal distortion due to RF overload before it can affect performance.

Category-Leading Setup and Operation Features

- CueMode allows monitoring of different stage mixes and storing of up to 20 separate channels on one bodypack for quick and easy reference.
- Front panel RF mute switch enables or disables RF transmission during setup.
- Scan and Sync scans the RF environment with the bodypack and assigns an identified group and channel to your system over wireless IR link.
- MixMode® technology allows the bodypack user to combine two separate audio channels for simultaneous listening in both ears, or can transmit two independent IFB program feeds. Balance control on the bodypack adjusts the relative levels for each audio signal.
- Four-band parametric EQ gives the user the choice to adjust frequencies for a fully customized sound.

Advanced Rechargeability Options

- The SB900A lithium-ion rechargeable battery provides extended usage times and precise tracking of remaining life and charge cycle details.
- The SCB800-US eight-bay charger brings up to eight SB900 batteries to full charge within two hours and has charge status LEDs for each battery.
- The SBC200 dual-docking charger works with SB900A, P3RA, P9RA+, P10R+, QLX-D® Digital Wireless Systems, and ULX-D® Digital Wireless Systems, available with and without power supply.
- The SBC220 networked dual-docking charger works with SB900A, PSM 300 (P3RA only), PSM 900 (P9RA+ only), PSM 1000 (P10R+ only), QLX-D Digital Wireless Systems, ULX-D Digital Wireless Systems, and Axient® Digital (AD1 and AD2 only), available with and without power supply. When the SBC220 is connected to a network, battery information for each transmitter can be viewed remotely.

Components

- **P9T:** Rack Unit Transmitter
- **P9RA+:** Bodypack Receiver
- **PS43:** Power supply
- Protective bumpers with 8 screws

Rackmount supplies

- ① Short rack ear
- ② Long rack ear
- ③ Link bar to mount to similar rack unit
- ④ 2 antenna hole plugs
- ⑤ 8 rack ear screws
- ⑥ 4 rack mount screws with washers
- ⑦ Extension cables and connectors for front-mounting antennas

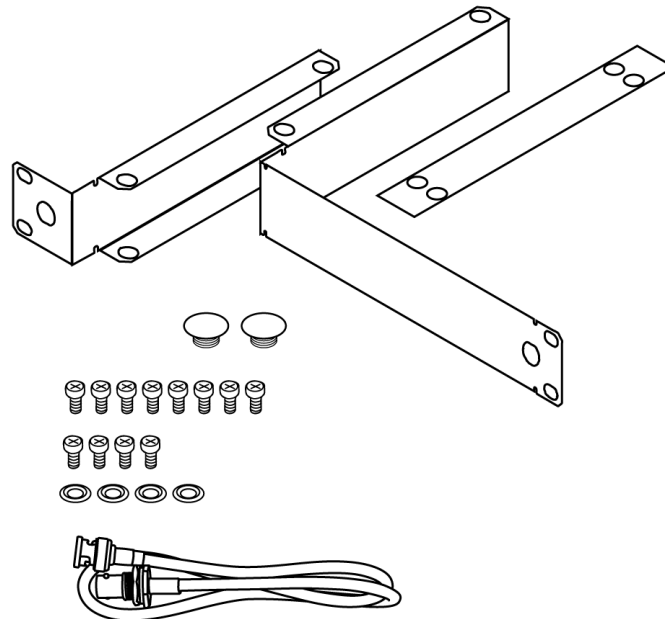

Quickstart Instructions

Rack Mount Transmitter

1. Connect to a power outlet using the supplied power adapter.
2. Attach the supplied antennas to the antenna out BNC connectors.
3. Connect the audio source, such as the output of a mixer, to the audio inputs. You can use both input jacks or choose either one for a mono source.
 - For mono (one input), access the Audio menu and select Mono.

- Set the input sensitivity to match the source by selecting Audio INPUT from the LCD configuration menu: Aux (-10dBV) or Line (+4dBu).
4. Make sure the RF switch is OFF. Turn the power ON.
 5. Adjust the audio source level so that, for the average input signal level, the top two yellow LEDs flicker and the lower LEDs are solid.
 - If the red clip LED illuminates, the inputs are overdriven. Decrease the level using the ▼ ▲ buttons or change the input sensitivity to +4 dBu.
 - If the signal level is too low, change the input sensitivity to -10 dBV

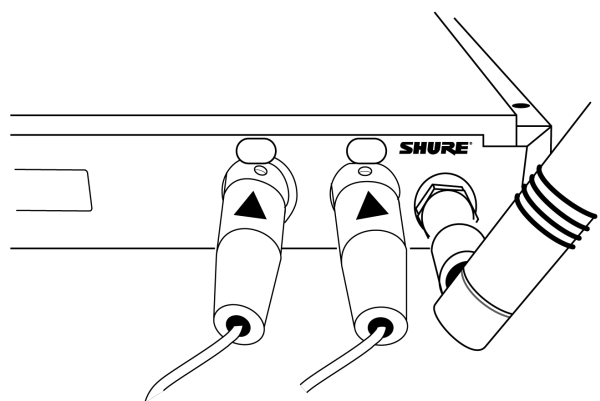
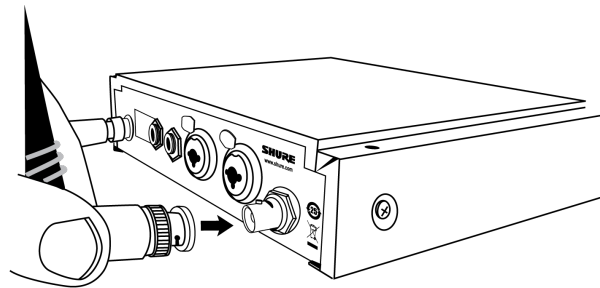
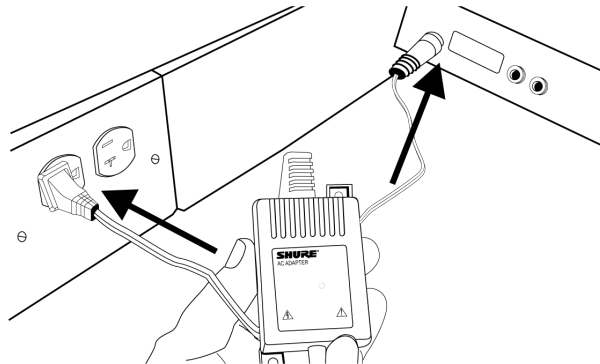

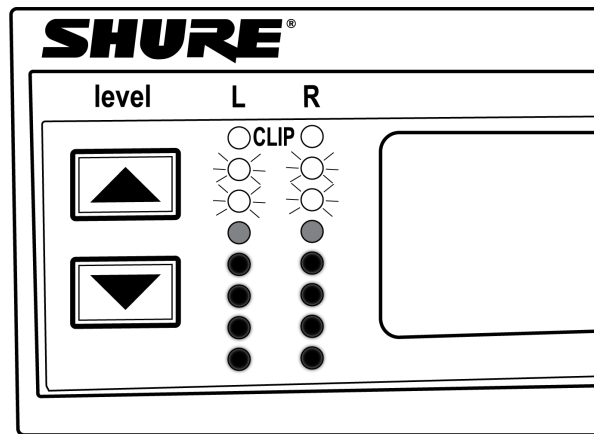
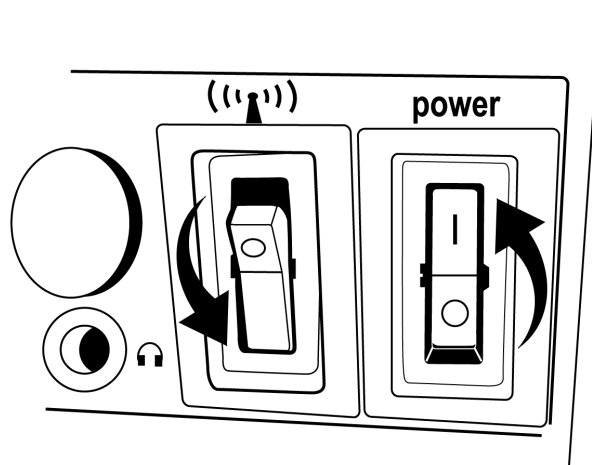

Bodypack

Insert batteries and attach antenna. Turn on using the volume knob. The battery light illuminates.

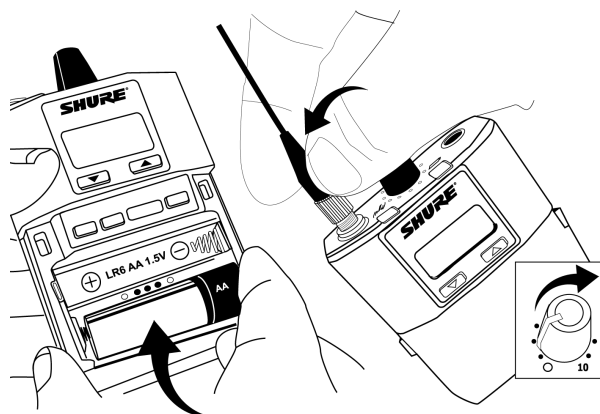

Scan and Sync

1. On the bodypack, press the scan button. The display flashes SYNC NOW...
2. Align the IR windows on the bodypack and rack unit and press the sync button. The rack unit Level LEDs flash, and it displays SYNC SUCCESS.
3. Turn the RF switch on. The blue RF LED illuminates on the bodypack to indicate that it is detecting the transmitter. The bodypack also displays the RF signal strength (RF).
4. **Important:** Turn bodypack volume down before plugging in earphones.
5. Insert the earphones and slowly turn up the volume.

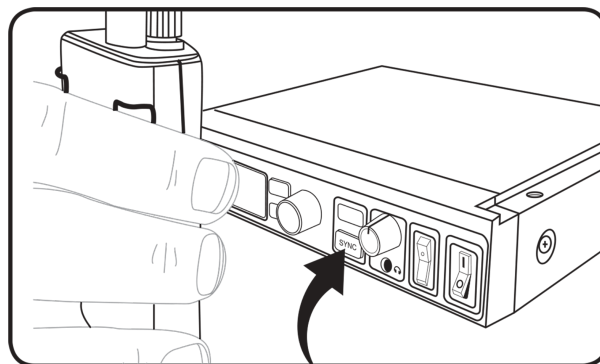
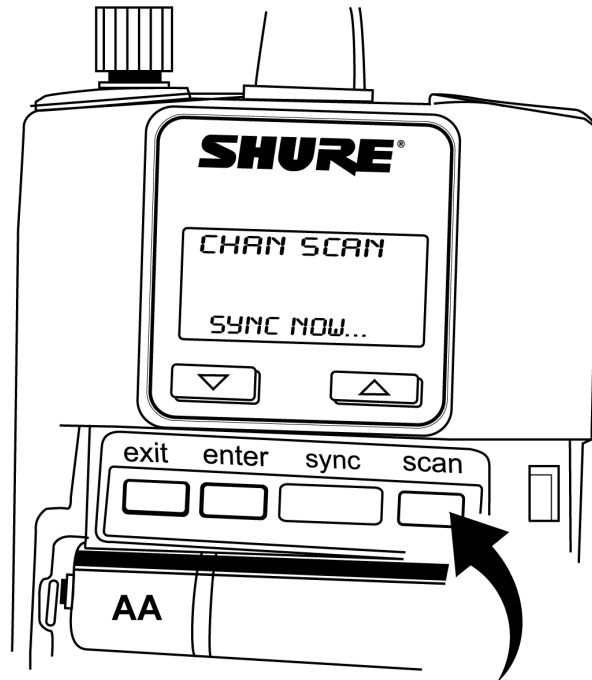

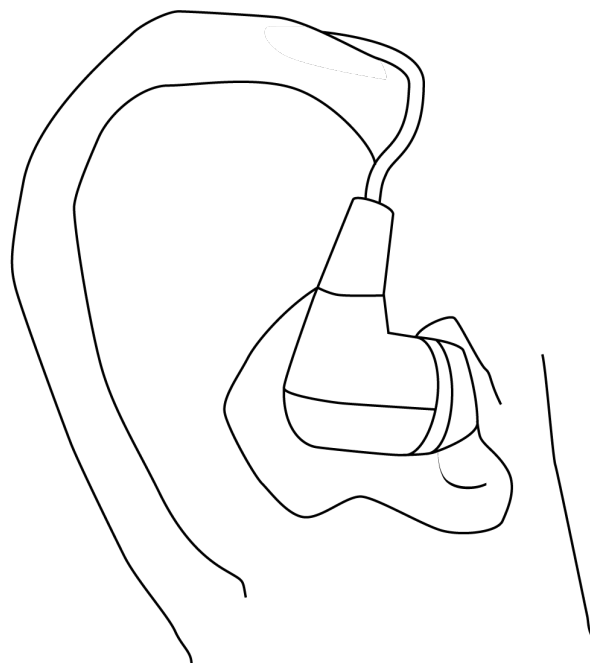
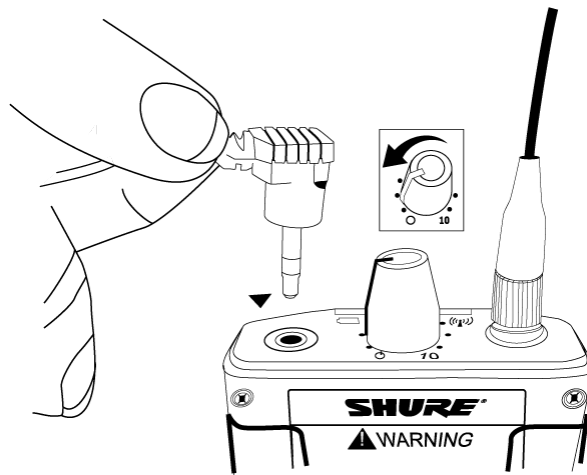
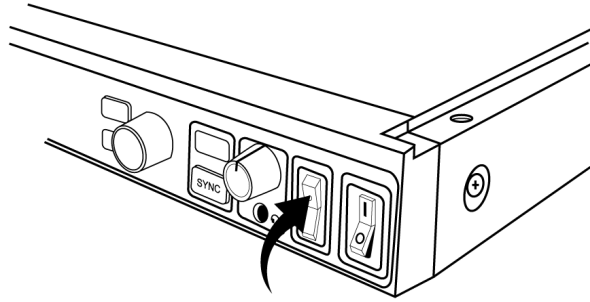

Important: Remove the protective film from the face of the transmitter or the IR sync may not work.

Rack Unit Transmitter

Front Panel Controls

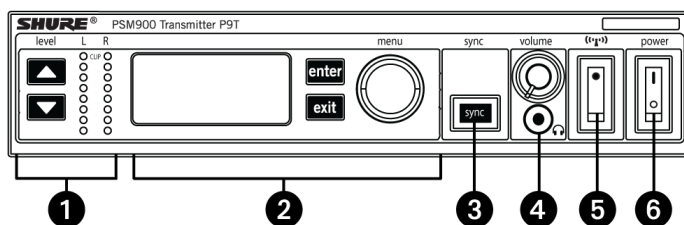

① Input Level Control and Display

Use the ▼ ▲ buttons to adjust the audio so that, for the average input signal level, the top two yellow LEDs flicker and the lower LEDs are solid. The red clip LED indicates the inputs are overdriven. Reduce the level at the audio source or change the input sensitivity of the rack unit from the AUDIO > INPUT menu.

② Status Display and Menu Controls

Use the enter and exit buttons and the menu wheel to access the configuration menu. Push the menu wheel to move the cursor to the next item. Turn the menu wheel to change a parameter—the enter button flashes. Press it to save the value. Press the exit button to cancel changes and return to the previous menu.

③ Synchronization Button

Press the sync button while rack unit and bodypack IR windows are aligned to transfer settings.

④ Headphone Monitoring

The volume control adjusts signal output to the 3.5 mm headphone jack. NOTE: it does not affect rear panel outputs.

⑤ RF switch

Mutes RF output. For setting up multiple systems or adjusting settings without transmitting unwanted RF or audio signals.

⑥ Power Button

Turns the unit on and off.

Rear Panel Connectors

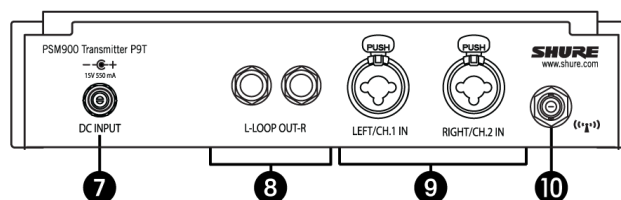

⑦ Power

Connect the transmitter to a power outlet using the supplied power adapter.

⑧ LOOP OUT

Sends a copy of the audio signal going into the transmitter to another device. See *LOOP Applications*.

⑨ Audio Inputs

Connect to balanced or unbalanced outputs. Use either connector for mono input. Accepts both 1/4-inch or male XLR connectors.

⑩ Antenna (BNC)

Attach supplied antenna. If you are rack mounting, use a front panel or remote mounting kit from Shure.

Configuration Menu

Note: Configuration menu items may vary with regional model variations.

RF Settings

RADIO

G

Sets the group number

CH

Sets the channel number

888.888MHz

Manual frequency selection

RF POWER

Select from 10, 50, or 100 mW (varies by region)

Audio Settings

AUDIO > MODE

Selects monitor mode

STEREO/MX

Transmits both channels

MONO

Transmits a mono signal to bodypack

AUDIO > INPUT

Sets nominal input level

LINE +4 dBu

line level

AUX -10dBV

aux level

Utilities and Display Settings

UTILITIES

EDIT NAME

Changes the name on the LCD display (this name is uploaded to the bodypack with sync)

DISPLAY

Changes the display format

CONTRAST

Changes the display contrast

CUSTOM GROUP

For creating custom frequency groups

UTILITIES > LOCK PANEL

Locks front panel controls. To unlock, press exit, select OFF, and press enter.

MENU+LEVEL

Locks menu and level controls.

MENU ONLY

Locks only the configuration menu (menu controls).

MENU+SWITCH

Locks all controls except for the level buttons (including the RF and power switches).*

ALL

Locks all controls (including the RF and power switches).*

*RF is automatically activated when locked. When you unlock the unit, RF and power turns off if the switches are off.

UTILITIES > RX SETUP

These settings are sent to the bodypack during a sync (when the sync direction is from the transmitter). The default KEEP parameter will not change the bodypack settings.

LOCK

Lock bodypack

V LIMIT

Volume limiter

LIM VAL

Volume limiter value

MODE

Stereo (ST) or MixMode (MX)

BAL MX

CH. 1 (L) and CH. 2 (R) mix for MixMode

BAL ST

Left (L) and right (R) balance for stereo mode

HIBOOST

high frequency boost

UTILITIES > RESET SYSTEM

Returns all settings to the factory defaults

NO

Exit and do not reset system.

YES

Reset system settings.

Bodypack Receiver

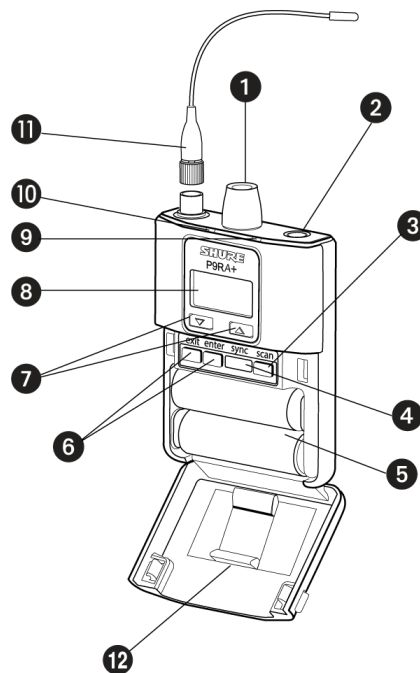

① Power Switch and Volume Control

Turns the bodypack on and off and adjusts earphone volume.

② 3.5 mm Earphone Jack

Insert earphones here.

③ Scan Button

Press the scan button to find an available frequency. Press and hold for two seconds to find the group with the most available channels.

④ IR Window

For transmitting settings between bodypack and rack unit.

⑤ Battery Compartment

Requires 2 AA batteries or Shure rechargeable battery. Open by pressing the latches on both sides and pulling.

⑥ Menu buttons

Use in conjunction with the ▼ ▲ buttons to access the configuration menus.

⑦ ▼ ▲ Buttons

Use to adjust the audio mix (in MixMode only), or in conjunction with the menu buttons to change settings.

⑧ LCD Screen

Displays current settings and menus.

⑨ Tri-Color Battery LED

Illuminates green, amber, or red to indicate battery power. When red, change battery immediately.

⑩ Blue RF LED

Indicates the bodypack is receiving a signal from the transmitter.

⑪ SMA Connector

For detachable antennas.



⑫ Removable AA Adapter

Remove to use with a Shure SB900 rechargeable battery.

Note: To remove adapter, open door and slide out. To reinstall adapter, place over the clip and press, there will be an audible click when seated.

Battery Life

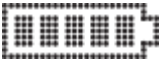
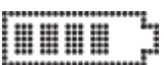
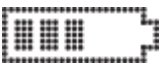
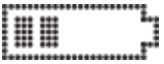
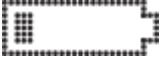
Battery Indicator	Tri-Color Battery LED	Approximate Hours Remaining (h:mm)					
		Alkaline			Shure SB900A Rechargeable Battery		
		Volume Level			Volume Level		
		4	6	8	4	6	8

	Green	6:00 to 3:50	4:20 to 2:45	3:15 to 2:05	8:00 to 3:45	6:45 to 3:45	6:00 to 3:45
	Green	3:50 to 2:50	2:45 to 2:00	2:05 to 1:30	3:45 to 2:45	3:45 to 2:45	3:45 to 2:45
	Green	2:50 to 1:15	2:00 to 1:00	1:30 to 0:50	2:45 to 1:45	2:45 to 1:45	2:45 to 1:45
	Green	1:15 to 0:25	1:00 to 0:20	0:50 to 0:20	1:50 to 0:55	1:50 to 0:55	1:50 to 0:55
	Amber	0:25 to 0:15	0:20 to 0:10	0:20 to 0:10	0:55 to 0:25	0:55 to 0:25	0:55 to 0:25
	Red	< 0:15	< 0:10	< 0:10	< 0:25	< 0:25	< 0:25
Total Battery Life		6:00	4:20	3:15	8:00	6:45	6:00

Power-save mode: When there are no earphones plugged in for 5 minutes, the receiver enters power-save mode to preserve battery life. The LED slowly fades on/off in this mode and continues to display the color that represents the remaining battery life.

Note: Battery life using Energizer brand AA Alkaline batteries and the following conditions:

- Receiver audio set to V LIMIT = 0dB
- Transmitter audio INPUT set to Line+4 dBu and Level set to -9 dB
- Audio input to the transmitter: pink noise at +8.7 dBV
- Audio output at receiver: 115 dB SPL in ear with SE425 earphones (impedance at 22 Ω) set at volume level 4.

Note: Using lower-impedance earphones or ones with different sensitivity, different battery types, and higher gain settings in the PSM system may cause the receiver battery life to be different than specified.

Pink noise is a signal with a frequency spectrum such that the power spectral density is inversely proportional to the frequency. In pink noise, each octave carries an equal amount of noise power.



Configuration Menu

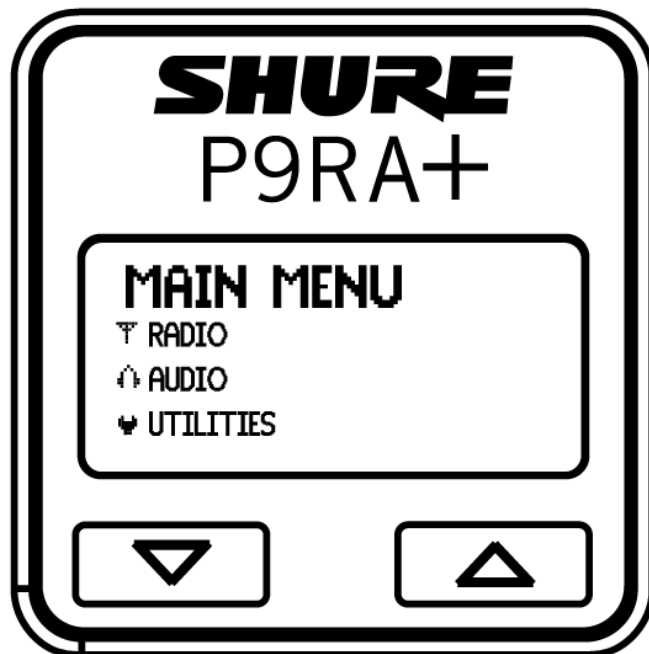

RF Settings

Access the following RF settings from the RADIO menu.

RADIO

G:

Group number. Each group contains channels selected to work well together in a single installation.

CH:

Channel number. Sets the receiver to a channel in the selected group.

888.888 MHz

Displays the frequency to which the receiver is set. Highlight and use the ▼ ▲ buttons to set to a specific frequency.

SQUELCH

Adjusts the squelch setting.

RF PAD

Attenuates antenna signals in 3 dB increments.

Audio Settings

Access the following audio settings from the Audio menu.

Output Mode (MODE)

STEREO

Receive left and right inputs as a stereo signal

MIXMODE®

Set your receiver to combine the left and right channel for simultaneous listening in both ears or pan to listen to only the left or right channel

Four-Band Parametric Equalizer (EQ)

The parametric equalizer is divided into four frequency bands: LOW, LOW MID, HIGH MID, and HIGH. When the EQ is enabled, the following parameters are adjustable:

FREQUENCY

Select the center frequency of the band to boost/cut

Q

Adjusts the width and slope of the frequency band (measured in octaves)

GAIN

Adjustable in 2 dB increments from -6 dB (cut) to +6 dB (boost)

NOTE: HIGH and LOW are shelf filters, and therefore do not have adjustable Q widths. The HIGH shelf is fixed at 10 kHz; the LOW shelf is fixed at 100 Hz.

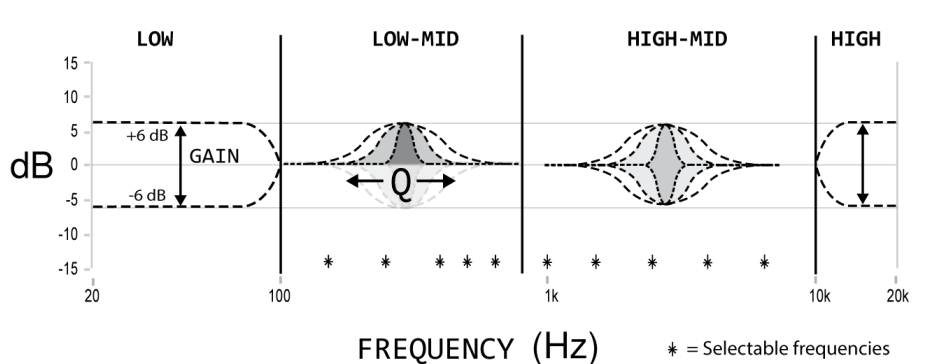

Volume Limiter (V LIM)

V LIM

Set a value (OFF to -48 dB, adjustable in 3 dB increments) to attenuate the highest possible volume level. Turning the volume knob through its entire range of motion still affects volume; the limit simply narrows the range of dB adjustment.

Note: The volume limit does not compress the audio signal.

Volume Lock (V LOCK)

P9RA+ and P10R+ only

ON

The volume is locked to the physical position of the volume knob

Input EQ Preset (EQPre)

Input EQ affects the signal after it is sent to the receiver, but before the headphone output, modifying the overall sound of the entire system.

Match (default)

Matches the frequency response of legacy PSM receivers, allowing for matched audio with mixed-inventory setups

Flat

Offers a flat frequency response curve

Off

Audio bypasses input EQ

Balance (BAL ST / BAL MIX)

▼ ▲ **Buttons**

Left and right balance for earphones when in stereo mode, or mix of left and right channel for MixMode

Utilities and Display Settings

Access the following settings from the UTILITIES menu.

UTILITIES

CUEMODE

Enters CUEMODE (to exit, press enter and select EXIT CUEMODE)

DISPLAY

Change the display settings on the bodypack

CONTRAST

Sets display brightness to high, low, or medium.

LOCK PANEL

Locks all controls except power and volume. To unlock, press exit, select OFF, and press enter.

BATTERY

Displays the following: Hrs: Min Left, temperature, Status, Cycle Count, and Health.

RESTORE

Returns receiver to factory default settings.



Multiple System Setup

When setting up multiple systems, designate a single bodypack to scan for available frequencies and download them to all the rack units.

The bodypack must be from the same frequency band as all the transmitters.

1. Power on all the rack units. **Turn off the RF.** (This prevents them from interfering with the frequency scan.)

Note: Turn **on** all other wireless or digital devices as they would be during the performance or presentation (so the scan will detect and avoid any interference they generate).

2. Use the bodypack to **scan for a group** by pressing and holding the scan button for **two seconds**. The bodypack displays the group and the number of available channels, and flashes SYNC NOW....

Important: Note the number of available channels. If you have more rack units than available channels, eliminate potential sources of interference and try again, or call Shure Applications for assistance.

3. Sync the bodypack with the first rack unit by aligning the IR windows and pressing sync.
4. Press scan again on the bodypack to find the next available frequency.
5. Sync the bodypack with the next rack unit.
6. Repeat with all the rack units.
7. Sync each performer's bodypack to its respective rack unit by aligning the IR windows and pressing sync. **DO NOT** press scan on the bodypacks.
8. Turn on the RF on all rack units. The systems are ready to use.

CueMode

CueMode allows you to upload the name and frequency settings from multiple rack units and store them as a list on a single bodypack. You can then, at any time, scroll through that list to hear the audio mix from each transmitter, just as each performer does during a show.

CueMode lists are retained even if CueMode is exited, the bodypack is turned off, or batteries are removed.

Note: Set the channel frequency and assign display names for each transmitter **before** creating your CueMode list.

Adding Transmitters to the CueMode List

Note: The transmitter must be from the same frequency band as the bodypack.

1. Open the battery door and press the enter button.
2. From the main menu, scroll to UTILITIES and press enter. Select CueMode and press enter again.
3. Align IR windows and press sync on the rack unit.

The LCD displays SYNC SUCCESS after frequency and name data are uploaded to the CueMode list. It also displays the CueMode number for that transmitter and the total number of transmitters.

4. Repeat the above step for each transmitter.

Note: Syncing while in CueMode does not change any of the settings on the bodypack.

Auditioning Mixes

1. Enter CueMode from the UTILITIES menu.
2. Use the ▼ ▲ buttons to scroll through your CueMode list to hear the mixes.

Exiting CueMode

Exit CueMode by pressing enter and selecting EXIT CUEMODE.

Managing CueMode Mixes

While in Cue Mode, you can access the following menu by pressing enter:

REPLACE MIX

Select and press sync on a rack unit to upload new data for the current mix (for example, if you have changed the transmitter frequency).

DELETE MIX

Removes the selected mix.

DELETE ALL

Removes all mixes.

EXIT CUEMODE

Exits CueMode and returns the bodypack to the previous frequency setting.

Frequency Scan

Use a frequency scan to analyze the RF environment for interference and identify available frequencies.

- **Channel Scan** Press the scan button on the bodypack. Finds the first available channel.
- **Group Scan** Press and hold the scan button for two seconds. Finds the group with the greatest number of available channels. (Each group contains a set of frequencies that are compatible when operating multiple systems in the same environment.)

Note: When performing a frequency scan:

- **Turn off** the RF on the transmitters for the systems you are setting up. (This prevents them from interfering with the frequency scan.)
- **Turn on** potential sources of interference such as other wireless systems or devices, computers, CD players, large LED panels, effects processors, and digital rack equipment so they are operating as they would be during the presentation or performance (so the scan will detect and avoid any interference they generate).

Sync

You can transfer frequency settings in either direction: from the bodypack to the rack unit, or from the rack unit to the bodypack.

Note: You can also choose to transfer other settings to the bodypack during a sync, such as lock or mode settings, using the Sync > RxSetup menu on the rack transmitter.

Downloading settings from the bodypack

1. Press the scanbutton on the bodypack.
2. Align the IR windows and press the syncbutton from the rack transmitter LCD menu while the bodypack display is flashing "SYNC NOW...".

The level LEDs on the rack unit flash.

Sending settings to the bodypack

1. Press the Sync button on the rack transmitter to access the sync menu.
2. Align the IR windows.

When properly aligned the IR window on the transmitter illuminates.

3. Press Sync to transfer settings.

The blue LED on the bodypack flashes.

MixMode

Some performers need to hear more of their own voice or instrument, while others want to hear more of the band. With MixMode, the performer creates their own mix using the balance control (▼ ▲ buttons) on the bodypack.

To use MixMode, send a solo mix of the performer to the L/CH1 input on the transmitter, and send a band mix to the R/CH2 input.

Set the performer's bodypack for MixMode. The bodypack combines the two signals and sends them to both earphones, while the balance control on the bodypack adjusts the relative levels for each.

For IFB applications, send two independent program feeds into the L/CH1 and R/CH2 input of the transmitter. With MixMode, the director or broadcast talent can listen to either feed using the balance control (▼ ▲ buttons) on the bodypack to pan to either audio signal.

LOOP Applications

Use LOOP OUT L (left) and R (right) outputs to send a copy of the audio signal going into the transmitter to other devices. Following are a few of the many applications for these outputs.

Note: The input level control and the input pad do not affect the LOOP OUT signals.

MixMode for Multiple Systems

Configure each system for MixMode. From the mixing console, send a mix of the whole band to input 2 of the first transmitter. Connect the LOOP OUT R output to the R/CH2 input of the next transmitter. Continue the chain with all the transmitters.

Next, create solo mixes for each performer. Send each mix to input 1 of the transmitter for that performer.

Floor Monitors

Send the audio from the LOOP outputs to onstage loudspeakers. The bodypack and the onstage monitors receive the same audio signals.

Note: The LOOP audio outputs will not drive passive loudspeakers, and must be sent to a power amplifier or an active loudspeaker.

Recording Devices

To record a performance, connect the LOOP outputs to the inputs of a recording device.

Squelch

Squelch mutes audio output from the bodypack when the RF signal become noisy. While squelch is activated, the blue LED on the bodypack turns off.

For most installations, squelch does not need adjustment, and it keeps the performer from hearing hiss or noise bursts if the RF signal becomes compromised. However, in congested RF environments or in close proximity to sources of RF interference (such as large LED video panels), the squelch may need to be lowered to prevent excessive audio dropouts. With lower squelch settings, the performer may hear more noise or hiss, but will experience fewer audio dropouts.

Important: Before lowering squelch, first try to eliminate the problem by finding the best set of frequencies for your installation and removing potential sources of interference.

Caution: Turning off or lowering the squelch setting can increase the noise level and cause discomfort to the performer:

- Do not lower the squelch setting unless absolutely necessary.
- Turn earphone volume to the lowest setting before adjusting squelch.
- Do not change the squelch setting during a performance.
- Turn up the transmitter level setting to make noise or hiss less noticeable.

Squelch Settings

HIGH (NORMAL)		Default factory setting.
MID		Moderately decreases the signal-to-noise ratio required to squelch the receiver.
LOW		Greatly decreases the noise squelch threshold.
PILOT ONLY*	⊘	Turns off noise squelch leaving only pilot squelch on.
NO SQUELCH*	⊗	Turns off noise and pilot tone squelch. (Sometimes used as a debugging tool by monitor engineers or RF coordinators to "listen" to the RF environment.)
* Symbol appears in display window.		

Point-to-Point Wireless Audio

Use PTP mode to allow a P9T to transmit to a UHF-R receiver. This allows a transmitter and receiver setup where both units are racked and powered by AC.

For more information visit: www.shure.com/americas/products/personal-monitor-systems

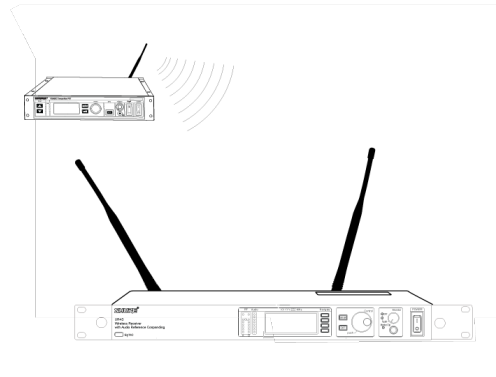

Specifications

PSM 900

RF Carrier Range

470–952 MHz

varies by region

Compatible Frequencies

Per band	20
-----------------	----

Tuning Bandwidth

36–40 MHz

Note: varies by region

Operating Range

environment dependent

90 m (300 ft)

Stereo Separation

60 dB

Audio Frequency Response

35 Hz –15 kHz (± 1 dB)

Signal-To-Noise Ratio

A-Weighted

90 dB (typical)

Total Harmonic Distortion

ref. ± 34 kHz deviation @1 kHz

<0.8% (typical)

Comanding

Patented Shure Audio Reference Comanding

Spurious Rejection

ref. 12dB SINAD

>80 dB (typical)

Frequency Stability

±2.5 ppm

MPX Pilot Tone

19 kHz (±0.3 kHz)

Modulation

FM*, MPX Stereo

*ref. ±34 kHz deviation @1 kHz

Operating Temperature

-18°C to +57°C

P9T

RF Output Power

selectable: 10, 50, 100 mW (+20 dBm)

RF Output Impedance

50 Ω (typical)

Net Weight

850 g

Dimensions

42 x 197 x 177 mm, H x W x D

Power Requirement

15V DC, 415 mA, typical

Audio Input

Connector Type

Combination XLR and 6.35 mm (1/4") TRS

Polarity

XLR	Non-inverting (pin 2 positive with respect to pin 3)
6.35 mm (1/4") TRS	Tip positive with respect to ring

Configuration

Electronically balanced

Impedance

70.2 k Ω (actual)

Nominal Input Level

switchable: +4 dBu, -10 dBV

Maximum Input Level

+4 dBu	+29.2 dBu
-10 dBV	+12.2 dBu

Pin Assignments

XLR	1=ground, 2=hot, 3=cold
6.35 mm (1/4") TRS	Tip=hot, Ring=cold, Sleeve=ground

Phantom Power Protection

Up to 60 V DC

Audio Output

Connector Type

6.35 mm (1/4") TRS

Configuration

Electronically balanced

Impedance

Connected directly to inputs

P9RA+

Front-End RF Filtering

-3 dB at 30.5 MHz from the center frequency of each band

Active RF Gain Control

31 dB

Adjusts RF sensitivity to provide more RF dynamic range

RF Sensitivity

at 20 dB SINAD

2.2 μ V

Image Rejection

>90 dB

Adjacent Channel Rejection

>70 dB

Latency

0.37ms

Squelch Threshold22 dB SINAD (± 3 dB)

default setting

Intermodulation Attenuation

>70 dB

Blocking

>80 dB

Audio Output Power*1kHz @ 1% distortion, peak power, @16 Ω*

100 mW (per output)

4-band Parametric EQ9.5 Ω **High Boost**

Low Shelf	Selectable Gain: ± 2 dB, ± 4 dB, ± 6 dB @ 100 Hz
Low Mid	Selectable Gain: ± 2 dB, ± 4 dB, ± 6 dB at 160 Hz, 250 Hz, 400 Hz, 500 Hz, 630 Hz Selectable Q: 0.7, 1.4, 2.9, 5.0, 11.5
High Mid	Selectable Gain: ± 2 dB, ± 4 dB, ± 6 dB at 1 kHz, 1.6 kHz, 2.5 kHz, 4 kHz, 6.3 kHz Selectable Q: 0.7, 1.4, 2.9, 5.0, 11.5
High Shelf	Selectable Gain: ± 2 dB, ± 4 dB, ± 6 dB @ 10 kHz

Volume Limiter

Selectable: OFF (0 dB) to -48 dB in 3 dB steps

Volume Lock

Selectable: 0 dB to -70 dB

Limits volume adjustment knob. Selected value analogous to volume knob increment.

Net Weight

154 g (Without Battery)

Dimensions

83 x 65 x 22 mm H x W x D

Battery Life

4–6 hours (continuous use) AA batteries

Frequency Range and Transmitter Output Power

Band	Range	Output
G6	470 –506 MHz	10/50/100 mW
G6E	470–506 MHz	10 mW
G6J	470–506 MHz	6/10 mW
G14	506–542 MHz	10 mW
G14J	506–542 MHz	6/10 mW
G62	510–530 MHz	10/50 mW
G7	506–542 MHz	10/50/100 mW
G7E	506–542 MHz	10/50 mW
G7Z	518–542 MHz	10/50/100 mW
H21	542–578 MHz	10**/50/100 mW
K1	596–632 MHz	10/50/100 mW
K1E	596–632 MHz	10 mW
K1J	596–632 MHz	6/10 mW
L6	656–692 MHz	10/50/100 mW
L6E	656–692 MHz	10/50 mW
L6J	656–692 MHz	6/10 mW
P7	702–742 MHz	10/50/100 mW
Q12	748–758 MHz	10/50 mW
Q15	750–790 MHz	10/50/100 mW
R21	794–806 MHz	10 mW
X7	925–937.5 MHz	10 mW
X1	944–952 MHz	10/50/100 mW
X55	941–960 MHz	10/50/100 mW

เครื่องโทรคมนาคมและอุปกรณ์นี้มีความสอดคล้องตามมาตรฐานหรือข้อกำหนดทางเทคนิคของ กสทช.

Furnished Accessories

Omnidirectional Whip Antenna, Yellow Tip (470-542 MHz)	UA700
Omnidirectional Whip Antenna, Black Tip (596-692 MHz)	UA720
Omnidirectional Whip Antenna, Blue Tip (670-830 MHz)	UA730
Omnidirectional Whip Antenna, Red Tip (830-952 MHz)	UA740
1/2 Wave Omnidirectional Receiver Antenna for improved wireless signal reception	UA8
Antenna extension cables (2)	95B9023
Carrying/Storage Bag	95A2313
Rackmount Bracket, Long	53A8612
Short Rack Bar	53A8611
Link Bars (Bracket)	53B8443
Hardware Kit (Rackmounting Screws)	90AR8100
Bumper Kit	90B8977
Power Supply	PS43

Optional Accessories

Passive Directional Antenna 470-952 MHz. Includes 10 foot BNC to BNC cable.	PA805SWB
PWS Helical Antenna, 480-900 MHz	HA-8089
PWS Domed Helical Antenna, 480-900 MHz	HA-8091
Helical Antenna, 944-954 MHz	HA-8241
Wideband Omnidirectional Antenna (470-1100 MHz)	UA860SWB
2 ft. BNC-BNC Coaxial Cable	UA802
6 foot (1.8m) BNC to BNC Coaxial Cable for Remote Antenna Mounting for ULX Wireless System	UA806
25 ft. BNC-BNC Coaxial Cable	UA825

50 ft. BNC-BNC Coaxial Cable	UA850
100 ft. BNC-BNC Coaxial Cable	UA8100
4-to-1 antenna combiner with power distribution to 4 transmitters (better RF performance and eliminates need for external power supply)	PA421B
8-to-1 antenna combiner for better RF performance	PA821B
Coiled IFB Earphone Cable for Shure Earphones	EAC-IFB

Certifications

P9RA+

Approved under the Declaration of Conformity (DoC) provision of FCC Part 15.

Certified by ISED in Canada under RSS-123.

P9T

Certified under FCC Part 74.

*Certified under FCC Part 15.

**Certified under FCC Part 15 and Part 74.

Certified by ISED in Canada under RSS-123 and RSS-102.

Meets essential requirements of the following European Directives:

- WEEE Directive 2012/19/EU, as amended by 2008/34/EC
- RoHS Directive EU 2015/863

Note: Please follow your regional recycling scheme for batteries and electronic waste

This product meets the Essential Requirements of all relevant European directives and is eligible for CE marking.

Hereby, Shure Incorporated declares that the radio equipment is in compliance with Directive 2014/53/EU. The full text of the EU declaration of conformity is available at the following internet address: <http://www.shure.com/europe/compliance>

Authorized European representative:

Shure Europe GmbH

Headquarters Europe, Middle East & Africa

Department: EMEA Approval

Jakob-Dieffenbacher-Str. 12

75031 Eppingen, Germany

Phone: +49-7262-92 49 0

Fax: +49-7262-92 49 11 4

Email: EMEAsupport@shure.de

低功率電波輻射性電機管理辦法

第十二條

經型式認證合格之低功率射頻電機，非經許可，公司、商號或使用者均不得擅自變更頻率、加大功率或變更原設計之特性及功能。第十四條

低功率射頻電機之使用不得影響飛航安全及干擾合法通信；經發現有干擾現象時，應立即停用，並改善至無干擾時方得繼續使用。前項合法通信，指依電信法規定作業之無線電通信。低功率射頻電機須忍受合法通信或工業、科學及醫療用電波輻射性電機設備之干擾。

Australia Warning for Wireless

This device operates under an ACMA class licence and must comply with all the conditions of that licence including operating frequencies. Before 31 December 2014, this device will comply if it is operated in the 520-820 MHz frequency band.

WARNING: After 31 December 2014, in order to comply, this device must not be operated in the 694-820 MHz band.