



# Designer

## System Configuration Software

The user guide for Shure Designer System Configuration Software.  
Version: 5.4 (2020-1)

# Table of Contents

<b>Designer System Configuration Software</b>	<b>3</b>	<b>Saving Presets</b>	<b>23</b>
<b>Overview</b>	<b>3</b>	<b>Event Log</b>	<b>24</b>
Features	4	<b>MXA910</b>	<b>25</b>
Getting Started	4	Configuring Microphone Coverage for MXA910	25
<b>Software Installation</b>	<b>7</b>	Ceiling Array Microphone Placement	27
Downloading the Application	7	Using Autofocus™ to Improve Coverage	28
System Requirements	8	<b>MXA710</b>	<b>28</b>
Automatic Configuration Updates	8	How to Adjust Microphone Coverage	29
Backup and Restore the Database	9	Using Autofocus to Improve Coverage	29
Supported Devices	10	<b>MXA310</b>	<b>29</b>
Change the Language of the Interface	10	Table Array Microphone Placement	29
<b>Organizing Your Designs</b>	<b>10</b>	<b>IntelliMix Room</b>	<b>33</b>
Creating a project	12	Using Videoconferencing Software with IntelliMix Room	34
Design Locations for each Room or Space	12	4	
Creating a New Location	12	Routing Microphone Signals to the DSP	34
Importing and Exporting Projects	12	<b>P300</b>	<b>36</b>
<b>Setting Up the Location</b>	<b>13</b>	Pre- and Post-Gain Metering	36
Adding Devices	13	Setting Up Mute Sync on the MXA310 and P300	36
Using Designer's Optimize Workflow	13	<b>ANIUSB</b>	<b>36</b>
Using the Coverage Map	15	Dante Transmit Flows	36
Keyboard Shortcuts for Coverage Map	16	Setting Up Mute Sync on the MXA310 and ANIUSB-MA-TRIX	37
Adding a Background Image	17	<b>Microflex™ Networked Ceiling Loudspeaker</b>	<b>37</b>
Positioning Devices Using the Grid and Guidelines	19	Routing Signals to the Loudspeaker	37
Moving, rotating, and resizing objects	20	Routing Signals to Multiple Loudspeakers	38
<b>Working with Virtual Devices</b>	<b>22</b>	<b>Network Mute Button</b>	<b>40</b>
<b>Pushing Designs to Discovered Devices</b>	<b>23</b>	How the Network Mute Button Works	40
Synchronize, Push, and Pull	23	Linking Mute Buttons to a Device	40

---

# Designer System Configuration Software

---

## Overview

Designer System Configuration Software enables integrators and system planners to design and implement accurate audio coverage for installations using a variety of select Shure microphones and other select Shure devices. Designer allows online and offline design, routing, configuration, and push to online devices, all in one tool. You can accurately model meeting and presentation spaces by importing a floor plan, scaling your room, positioning devices around participant areas, and arranging the pick-up lobes over the room diagram for precise coverage.

Designer allows you to create and edit coverage parameters before your devices are installed:

- identify the microphone positioning, room size, and ceiling height
- add channels
- create accurate coverage areas
- adjust equalizer settings
- manage signal routing

After completing your design work offline, you can push the settings to the live devices and fine-tune on site, all from within Designer. If you prefer, you can always export the device presets to upload and use each device's web user interface.

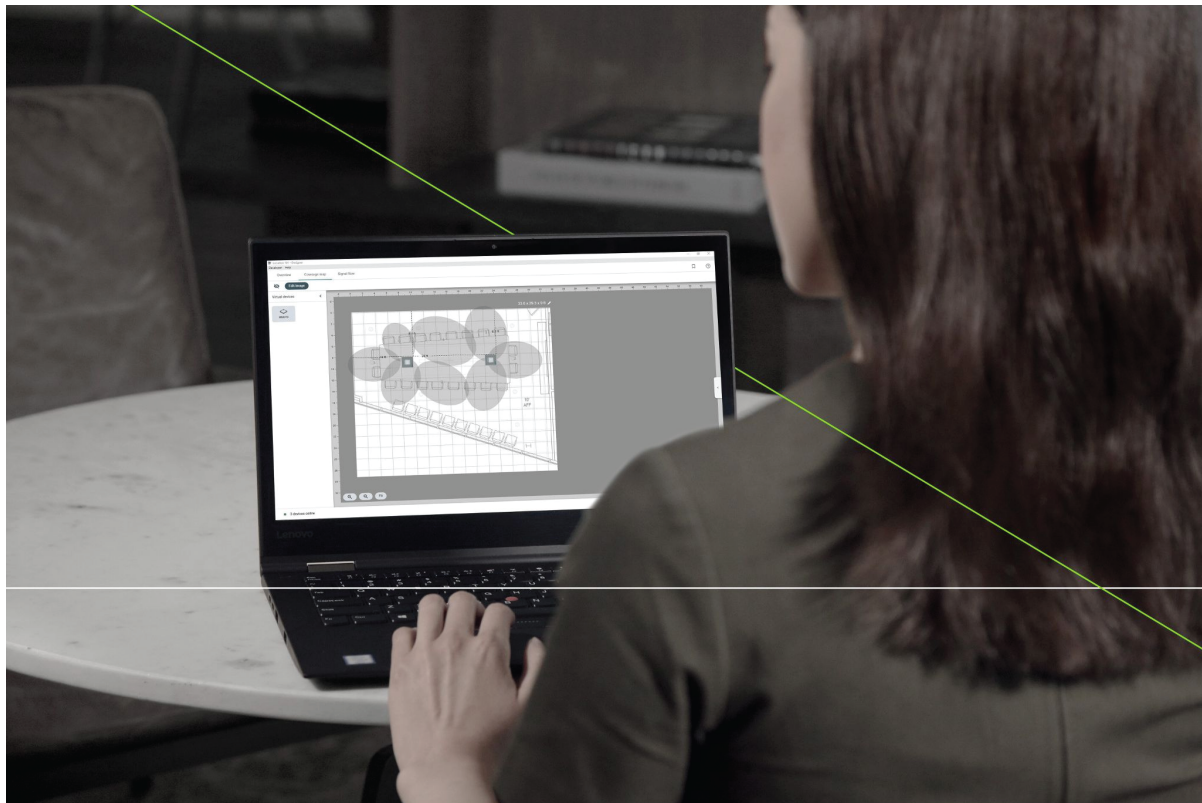

# Features

- Design audio coverage, whether online or offline, for installations using these Shure microphones and devices:
  - IntelliMix<sup>®</sup> Room
  - MXA910 Ceiling Array Microphone
  - MXA710 Linear Array Microphone
  - MXA310 Table Array Microphone
  - P300 IntelliMix Audio Conferencing Processor
  - ANIUSB-MATRIX USB Audio Network Interface
  - Microflex Networked Ceiling Loudspeaker
  - MXA Network Mute Button
- Accurately scale floor plans and reference photos for precise device setup
- Add multiple devices to create larger and more complex installations
- Perform the signal routing for multiple Shure products in one software tool
- Create and reuse templates across multiple locations
- Push settings to a group of devices at one time
- Easily export device presets for an individual location
- Organize installations for multiple rooms, buildings, and clients
- Save time and travel expenses by importing a floor plan and using virtual devices to design your system offline
- Share project files with other Designer users so that multiple people can work on a project

## Getting Started

### 1. Create a project

Start a Designer project and create a location that matches your planned environment. You can design a single room or create multiple rooms that match a building or campus layout.

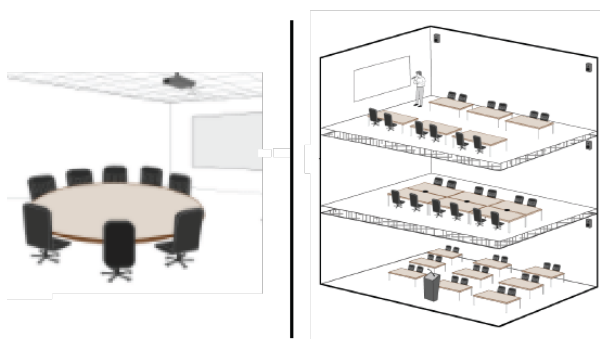

### 2. Add devices to your room

Drag the devices that you want to work with into the room.

- If you are discovering online devices on your network, you will automatically be in Live Mode and can add online devices to your location.
- If you are not discovering online devices, you will not be in Live Mode; you will be able to add virtual devices to design your system ahead of time.

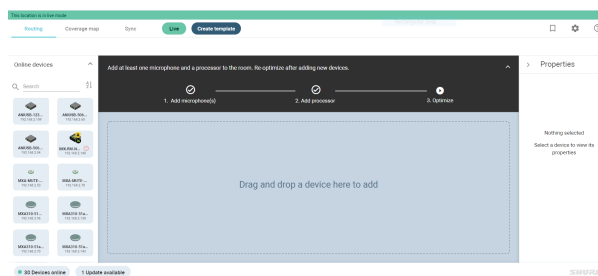

### 3. Optimize your room

Click Optimize to allow Designer to connect your Shure devices. You must have at least one microphone and one processor in a room to use Designer's Optimize feature.

Do you only have microphones? You can continue to make manual adjustments by selecting individual devices to adjust their properties to the right or click Configure to access and change the more advanced settings.

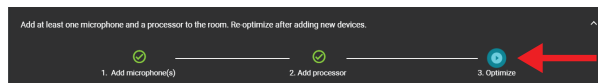

Designer's Optimize workflow speeds up the process of connecting systems with at least 1 microphone and 1 audio processor. Optimize also creates mute control routes in locations with MXA network mute buttons. When you select Optimize in a location, Designer does the following:

- Creates audio routes and mute control routes
- Adjusts audio settings
- Turns on mute synchronization
- Enables LED logic control for applicable devices

The settings are optimized for your particular combination of devices. You can customize settings further, but the Optimize workflow gives you a good starting point.

After optimizing a location, you should check and adjust settings to fit your needs. These steps may include:

- Deleting unnecessary routes.
- Checking levels and adjusting gain.
- Verifying that AEC reference signals are correctly routed.
- Fine-tuning DSP blocks as needed.

#### Compatible devices:

- MXA910
- MXA710
- MXA310
- P300
- IntelliMix® Room
- ANIUSB-MATRIX
- MXN5-C
- MXA Network Mute Button

## 4. Fine-tune your system

Use the Coverage map to configure the devices and adjust the coverage areas in your room. Additionally, you should select individual devices to adjust their properties to the right or click Configure to access and change the more advanced settings.

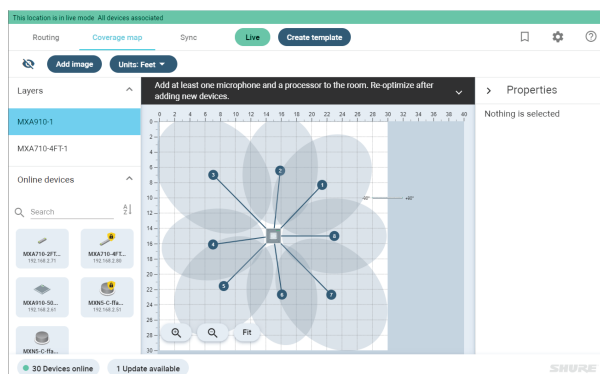

## 5. Device-specific tasks

- Ceiling and Linear array microphones and ceiling loudspeaker only:
  1. Coverage map tab - Size the location using the actual room dimensions and specifications.
  2. Use a floor plan or reference image to begin designing your location. Click Add image to import your floor plan and scale it to a reference point on the drawing.

Use the image to focus the audio coverage on the expected participant areas and design with greater accuracy using real room dimensions.

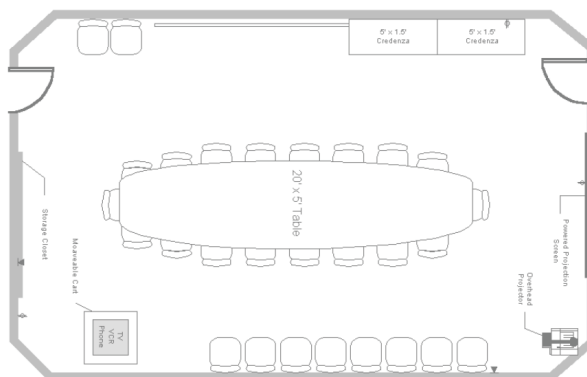

3. Add devices and position the channels around participant areas. Multiple devices can be set up in the same location, enabling excellent audio coverage for larger and more complex spaces. Click Add channel to cover the space with lobes.

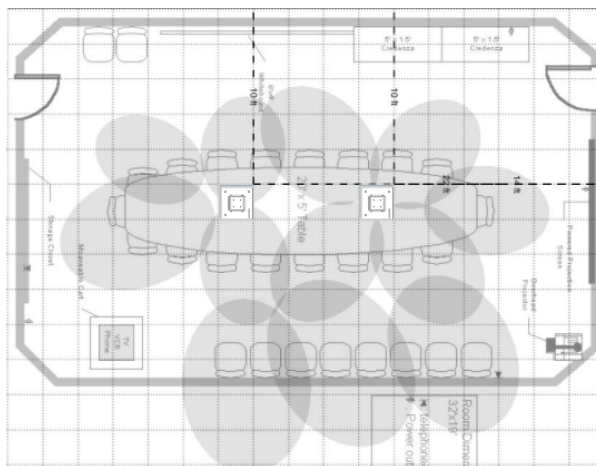

4. Use Designer to adjust the equalizer settings, manage the signal routing, and set device properties.
- Table array microphones only:
    1. Select the device and click Configure.
    2. Click Add channel to add channels for the microphone.
    3. Use Properties to make selections for the channel settings.
  - Other devices:
    1. Select the device and click Configure.
    2. Use the various features to make selections for the signal processing settings.

## 6. Final adjustments

To complete configuring the devices in your room, you can make changes directly to your devices and fine-tune each channel by listening to the sound check and making adjustments in real-time from within Designer.

# Software Installation

## Downloading the Application

Download the application and learn more at [www.shure.com/designer](http://www.shure.com/designer).

## Software Releases

New versions of this software are periodically released to include new features and performance improvements. This documentation supports the latest version of the software. For more information on individual releases, see the [release notes](#) on [www.shure.com](http://www.shure.com).

## Contact the Shure Support Team

Shure System Support provides regional support teams with in-depth knowledge of Shure devices, digital audio networking, and best practices for your installation. If you encounter any issues during installation or setup of the software, contact Shure System Support for assistance. In the Americas region, you can call 312-736-6006 or visit [www.shure.com](http://www.shure.com) to find your local support contact.

# System Requirements

## Prerequisites

## Required Ports

<b>Server Inbound Ports</b> <b>HTTP and Web Sockets</b>	80 (default)
<b>MongoDB</b> <b>Shure System API</b>	Two ports, dynamically allocated at install using available ports in the range of 10000-65535 A third port is selected by the user (default 80)

## Install Windows Updates

Make sure your operating system is up-to-date before software installation.

## Operating System

The follow operating systems are supported on a physical or virtual machine:

- Windows 10 (Professional or Enterprise), 64-bit edition
- Windows 7 (Professional or Enterprise), 64-bit edition

## Hardware

<b>System memory</b>	8 GB of RAM available
<b>Hard-disk space</b>	2 GB available
<b>Processor</b>	i5 Dual-core processor

## Automatic Configuration Updates

The following settings are automatically made during software installation.

## Installer Prerequisites

The following prerequisites are automatically added during the installation process:

- Microsoft .NET Framework 4.7.2
- MongoDB v3.4.0

## Windows Firewall

<b>LocalPort</b>	5568, 8427
------------------	------------



# Backup and Restore the Database

Protect against data loss by backing up the MongoDB database (installed with Designer) that stores your Shure software information. Backups are also useful when migrating to a new server.

Backups store all projects, locations, and device settings that your team makes in the software. For backup restoration, only those backup files (.bak) that match the current operating software version are supported.

## Identify the MongoDB port

You must identify the dynamically allocated port for MongoDB by looking in the configuration section of:

**"[location of Designer Software install directory]\Services\Mongo-3.4.0\Bin\mongod.cfg"**

The port number is specified in the following lines:

```
"
net:
port: [port #]
"
```

## Backup the Mongo Database

Use the machine installed with the software to create the MongoDB backup.

1. Identify a location to archive the database backup. You use this path in the command line.
2. Begin to open a command prompt by opening the Start menu and start typing "command". Do not press Enter.
3. Right-click the command prompt item and select Run as administrator.
4. Type the following command line (including quotation marks for file paths) after replacing the placeholders marked by [ ]:

```
"[location of Designer Software install directory]\Services\Mongo-3.4.0\Bin\mongodump.exe" --host localhost --port [MongoDB port number] --gzip --archive="[path and file name of backup]"
```

**Tip:** Sample command line with default settings:

```
"c:\Program Files\Shure\Shure Designer\Services\Mongo-3.4.0\Bin\mongodump.exe" --host localhost --port [MongoDB port number] --gzip --archive="c:\Shure.bak"
```

5. Press Enter. The file is archived at the path specified in the prompt.

## Restore a Database Backup

1. On the machine installed with the software, open a command prompt by opening the Start menu and start typing "command". Do not press Enter.
2. Right-click the command prompt item and select Run as administrator.
3. Type the following command line (including quotation marks for file paths) after replacing the placeholders marked by [ ]:

```
"[location of Designer Software install directory]\Services\Mongo-3.4.0\Bin\mongorestore.exe" --host localhost --port [MongoDB port number] --drop --gzip --archive="[path and file name of backup]"
```

**Tip:** Sample command line with default settings:

```
"c:\Program Files\Shure\Shure Designer\Services\Mongo-3.4.0\Bin\mongorestore.exe" --host localhost --port [MongoDB port number] --drop --gzip --archive="c:\Shure.bak"
```

4. Press Enter.

5. Reload the database configuration by typing

```
iisreset
```

at the command prompt.

## Supported Devices

The following Shure devices are supported in Designer. Whenever possible, upgrade to the latest supported firmware version to take advantage of new features and system improvements.

- MXA910 Ceiling Array Microphone ([User Guide](#))
- MXA710 Linear Array Microphone ([User Guide](#))
- MXA310 Table Array Microphone ([User Guide](#))
- IntelliMix Room Audio Processing Software ([User Guide](#))
- P300 IntelliMix Audio Conferencing Processor ([User Guide](#))
- ANIUSB-MATRIX Audio Network Interface ([User Guide](#))
- Microflex Networked Ceiling Loudspeaker ([User Guide](#))
- MXA Network Mute Button ([User Guide](#))

### Important:

- Designer 4.2 is compatible with the most current firmware versions
- Refer to the Release notes for a list of compatible firmware versions
- Exported projects are not backward compatible from Designer 4.2 to previous versions of Designer

See *Firmware Updates* for more information on updating firmware.

## Change the Language of the Interface

1. Access My Account by clicking the area in the upper left near your name.
2. Use the drop-down menu to select your preferred language.
3. Click Save changes.

---

## Organizing Your Designs

Shure Designer software helps you develop and organize your audio installation projects. Set up your projects to best reflect your work flow:

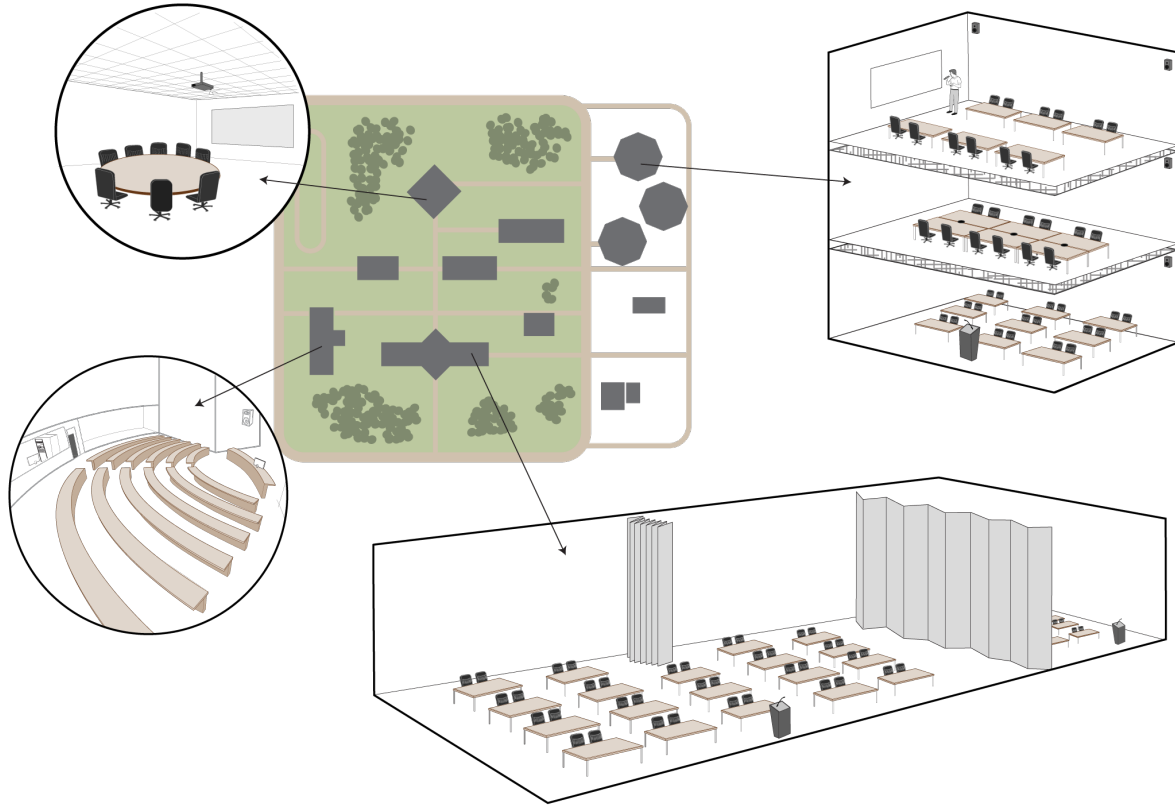

**Organize by project using locations**

*Projects are scalable: design a single room or develop several locations spanning buildings and campuses*

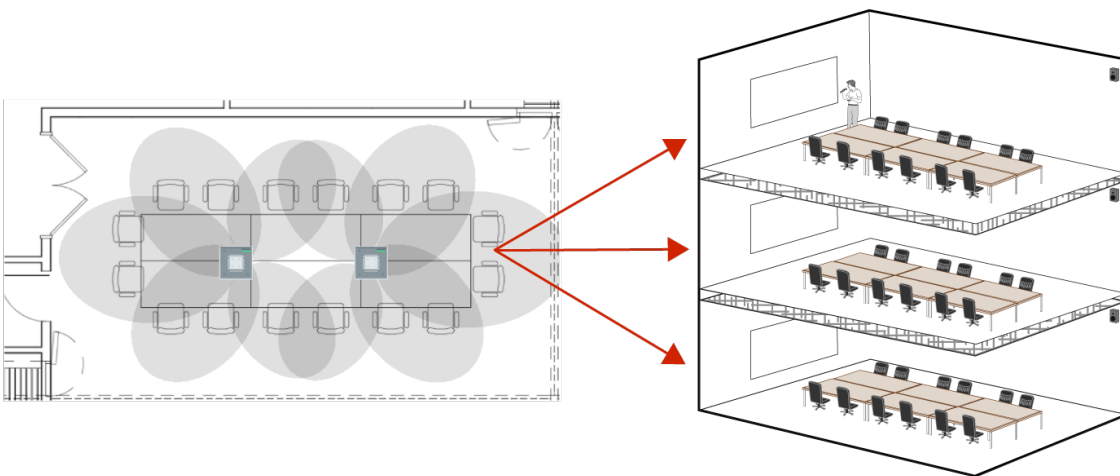

**Organize by layout using templates**

*Use templates to create designs for similar rooms*

## Creating a project

To create a project,

1. Click My projects in the menu on the left.
2. Click New > Project.
3. Type a name for your project and a description.
4. Click Create.

## Design Locations for each Room or Space

Designer uses locations so you can create multiple designs within each project. You can create a location in your project for each room and space you are designing. You can arrange and nest locations to match the project infrastructure (buildings and floors) or your own work flow (room types or templates).

## Creating a New Location

1. Open a project.
2. Select Locations if not already selected.
3. Click New > Location.
4. Type the name for your location and a description.
5. Click Create.

Designer creates a location with that name in your project list and opens a design window for that location.

If you are going to create multiple locations and prefer to group them into folders, you can create a folder first.

1. Open a project.
2. Select Locations if not already selected.
3. Click New > Folder.
4. Type the name of your folder and a description.
5. Click Create.

Designer creates a folder with that name and adds it to your project list.

Double-click the folder to open it and follow the previous steps to create a location.

## Importing and Exporting Projects

Export your Designer project to share and collaborate with other system designers, or to save a backup of your work. The export includes all locations within your project, including all virtual device settings, routing, and coverage designs.

Designer projects download as **.dprj** files and are only compatible with Shure Designer software.

### Importing a Project

1. Click My projects.
2. Click New.
3. Select Import project and browse to the file you want to import.

### Exporting a Project

1. Click My projects.
2. When you hover over a project,  (More), becomes available to the right. Click the icon.
3. Select Export. The file name is the project name in Designer .

# Setting Up the Location

## Adding Devices

You add virtual devices to your workspace by dragging them from the left side menu onto your workspace.

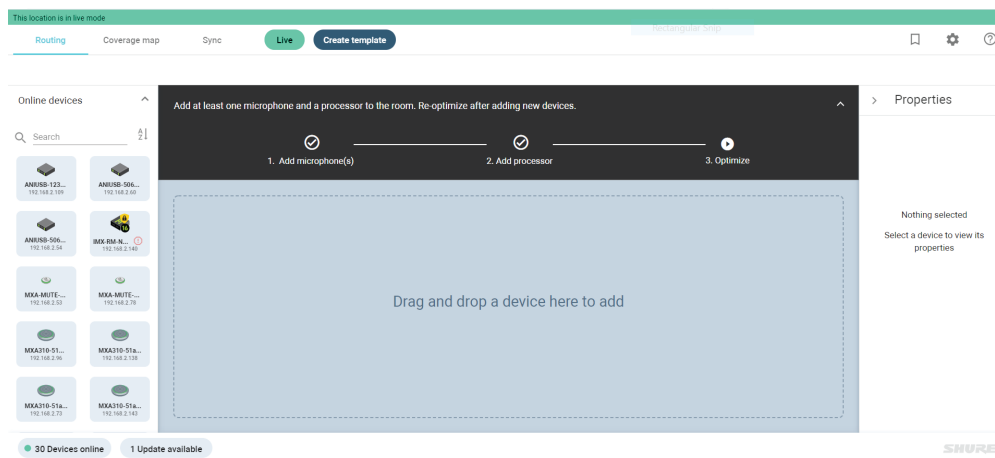

## Using Designer's Optimize Workflow

Designer's Optimize workflow speeds up the process of connecting systems with at least 1 microphone and 1 audio processor. Optimize also creates mute control routes in locations with MXA network mute buttons. When you select Optimize in a location, Designer does the following:

- Creates audio routes and mute control routes
- Adjusts audio settings
- Turns on mute synchronization
- Enables LED logic control for applicable devices

The settings are optimized for your particular combination of devices. You can customize settings further, but the Optimize workflow gives you a good starting point.

After optimizing a location, you should check and adjust settings to fit your needs. These steps may include:

- Deleting unnecessary routes.
- Checking levels and adjusting gain.
- Verifying that AEC reference signals are correctly routed.
- Fine-tuning DSP blocks as needed.

### Compatible devices:

- MXA910
- MXA710
- MXA310
- P300
- IntelliMix Room
- ANIUSB-MATRIX
- MXN5-C
- MXA Network Mute Button

**To use the Optimize workflow:**

1. Place all relevant devices in a location.
2. Select Optimize. Designer optimizes microphone and DSP settings for your equipment combination.

If you remove or add devices, select Optimize again.

## Routing

You can create Dante routes for the supported Shure devices by clicking and dragging to make connections between the devices.

- You can drag the devices to arrange them in the workspace. The Shure device names identify the devices.
- Hovering over the input or output on a device displays the Dante name, the Dante channel, and identifies it as an input or an output.
- Click on the input or output channel of one device and then click on the channel of the other device to create the route.

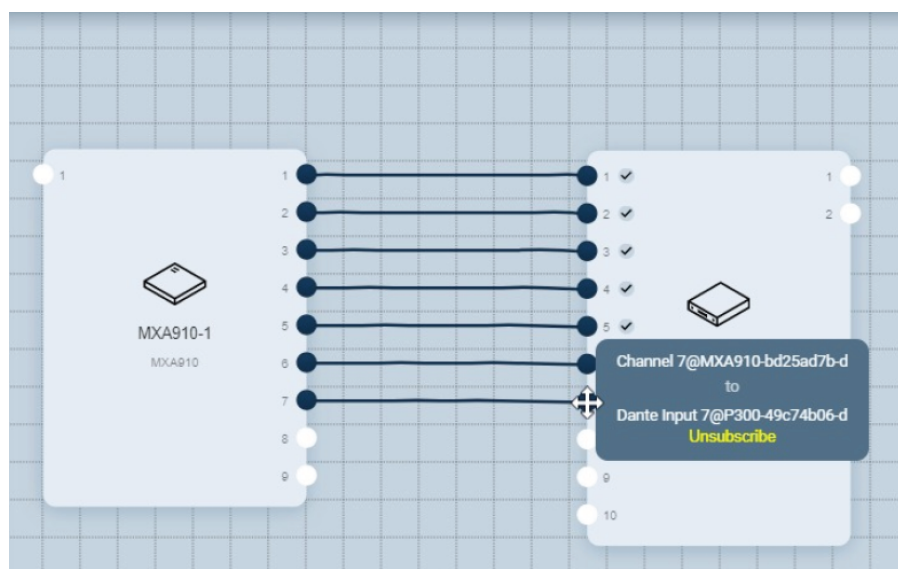



After Designer creates the route, hovering over either endpoint identifies the Dante device and channel connections.

**Note:** By default, Designer pushes the routes when pushing virtual device settings to the discovered devices, but you can opt out of creating and pushing routes if you are using a 3rd party DSP, for example.

## Determining Route Status

The Routing page uses icons to identify valid and invalid Dante routes :

-  — Indicates that you have successfully created a virtual route.
-  — Indicates that you have successfully created a valid route between discovered devices and are in Live mode.
-  — Indicates that this is an invalid route. The possible issues creating the invalid route and their resolutions are described in the following table:

Possible issue	Resolution
<b>Receiver cannot locate the subscribed transmitter.</b>  <b>or</b>  <b>Transmitter cannot locate the subscribed receiver.</b>	If simply offline, the online device will locate the offline device when it comes back online.
<b>Receiver can locate the subscribed transmitter, but there is a coding mismatch because one of the endpoints does not have encryption enabled, while the other one does.</b>	Re-key the encryption or disable encryption for both devices.
<b>Receiver can locate the subscribed transmitter, but there is a coding mismatch because the endpoints have different encryption keys.</b>	Re-key the encryption or disable encryption for both devices.
<b>Receiver can locate the subscribed transmitter, but there is a coding mismatch or other problem preventing proper operation across the route.</b>	Re-key the encryption or disable encryption for both devices.

## Using the Coverage Map

You use the Coverage map for the MXA910 Ceiling Array microphones, the MXA710 Linear Array microphones, and the Microflex Networked Ceiling Loudspeaker. The Coverage map is very helpful when you have added an image of the location and you can use it to position the microphone and its channels. You can drag one or more microphones onto the workspace, dragging to the desired position or typing the exact coordinates in Properties.

To create more accurate layouts, match the location specifications by editing the Workspace properties from the coverage editor or the Properties panel. To access workspace edit mode, you must click the dimensions above the workspace grid

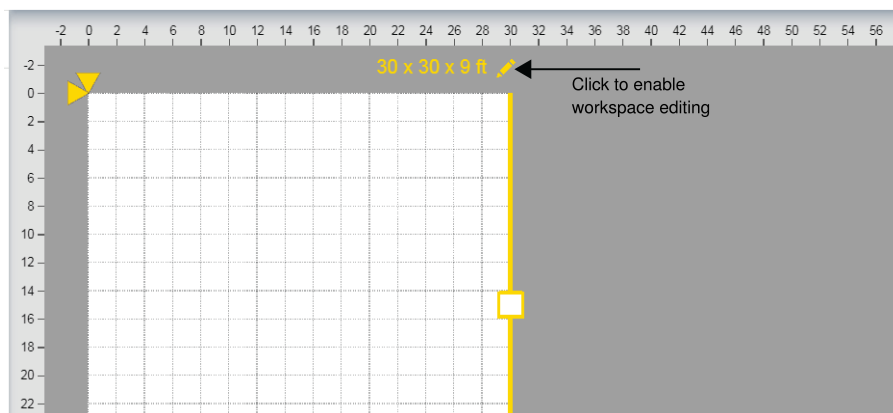

With editing enabled, you can modify your workspace properties:

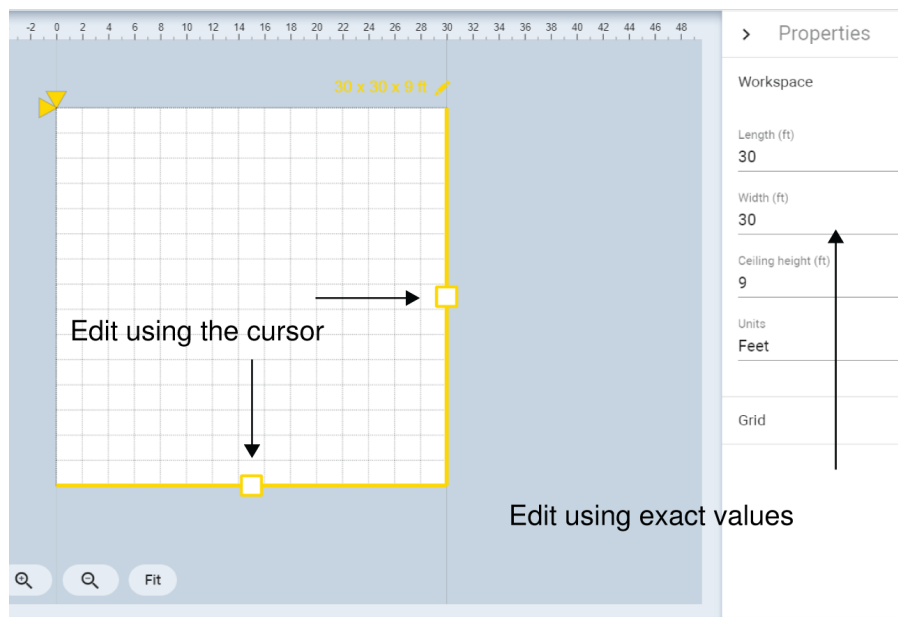

<b>Workspace</b>	
<b>Length and Width</b>	Set the length and width of your location.
<b>Ceiling height</b>	Set the ceiling height of your location. This setting becomes the default device height when you add a device, though you can change them independently at any time.
<b>Units</b>	<p>Select the unit of measure for your location:</p> <ul style="list-style-type: none"> <li>• Feet (default)</li> <li>• Meters</li> </ul> <p><b>Tip:</b> Match the unit of measure to your hardware device (for example, inches for MXA910-24IN or meters for MXA910-60CM).</p>
<b>Grid: Grid starting point (X and Y)</b>	Start the grid from a different point on the workspace to align with a reference object, such as a ceiling tile in the background image.

## Keyboard Shortcuts for Coverage Map

Shortcut	Description
<b>Delete</b>	Delete the selected device or channel
<b>Up, Down, Left, or Right</b>	<p>Move the selected device or channel</p> <p>Grid snap on: To the nearest grid</p>



Shortcut	Description
	Grid snap off: One unit of measure (0.1 feet or .01 meters)
<b>Shift + Rotate (drag using the mouse)</b>	Rotate the selected device or image in 45 degree increments
<b>Control wheel</b>	Zoom in or out on the workspace

## Adding a Background Image

Add a background image to your location to help focus the design around the participant seating arrangements and presentation areas. Images can be scaled to represent real room dimensions for accurately positioning devices and audio coverage.

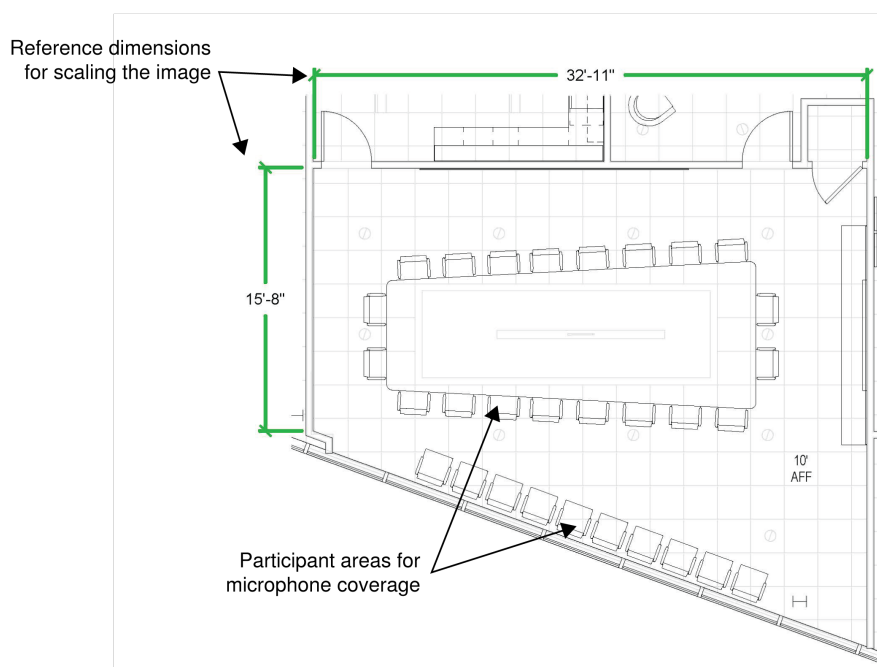

**Background image**

1. Open a location and click **Coverage map**.
2. Access workspace edit mode by clicking the dimensions above the workspace grid
3. Select Add image and browse to the image on your computer.
4. Select Open to add it to your workspace.

Supported file types:

- .jpg
- .jpeg
- .png
- .gif

## Redraw the Image to Scale

After you add an image to Designer, you can scale it based on a reference point in the drawing. If you do not know an actual measurement in your image, you can always scale the image later.

1. Add the image to the workspace.
2. Find an object in your drawing that has a known length.
3. Use the cursor to draw the reference line.

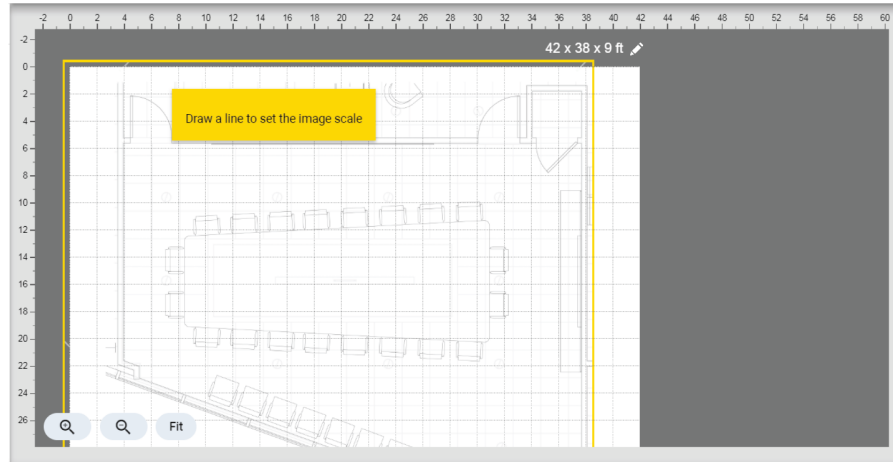

4. Enter the real length of the object into the reference size window and select Apply.

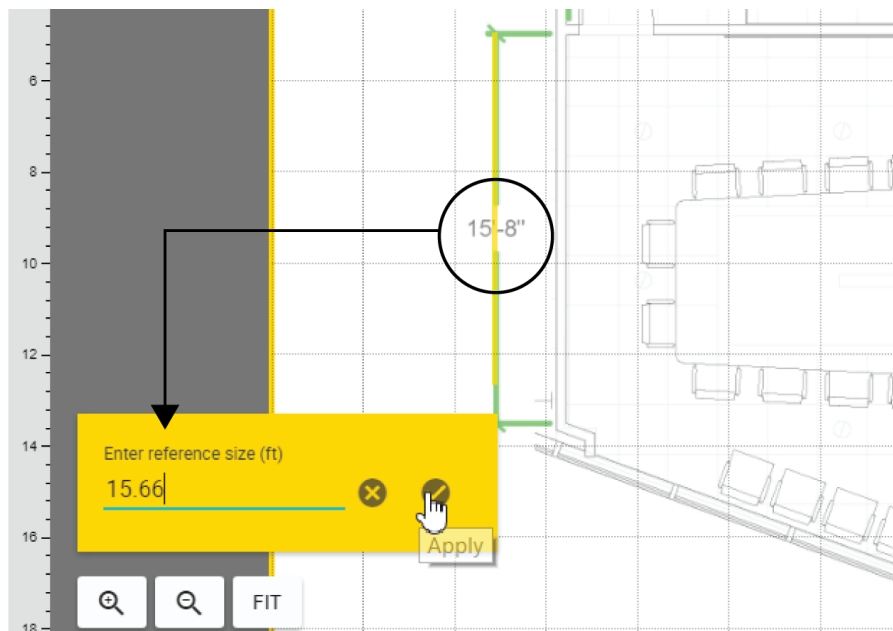

Scale the image using a reference dimension

5. Resize the workspace to fit the newly scaled image.

You can redraw to scale at any time from Edit image > Draw to scale.

## Positioning Devices Using the Grid and Guidelines

Use the grid in Designer to move objects to an exact point in the workspace. When Snap to grid is selected, the device reference corner aligns automatically to the closest grid corner.

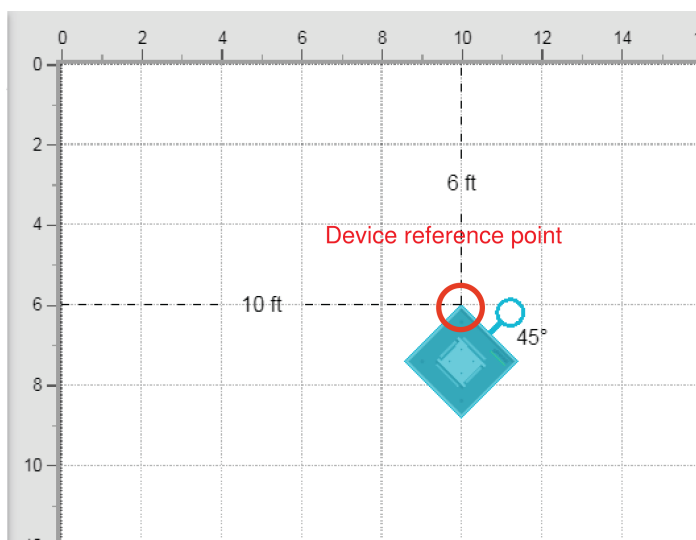

**Aligning devices on the grid**

Open  (Options) on the coverage page to enable or disable the positioning tools:

- Show grid assists with aligning objects.
- Snap to grid ensure that objects align precisely on the workspace.
- Show guides displays the X and Y coordinates to the device reference point from the workspace 0,0 coordinates
- Shift + Grabbing the rotation handle restricts rotation to 45 degree increments.

## Grid Offset

Align the grid with a reference point in your image, such as a ceiling tile or door frame, by adjusting the grid offset.

1. Enter edit mode by selecting the dimensions above the workspace.

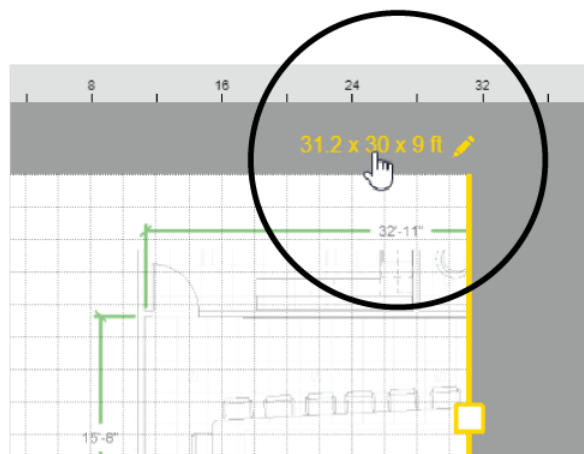

- Grab the grid offset tool and move it to the reference line.

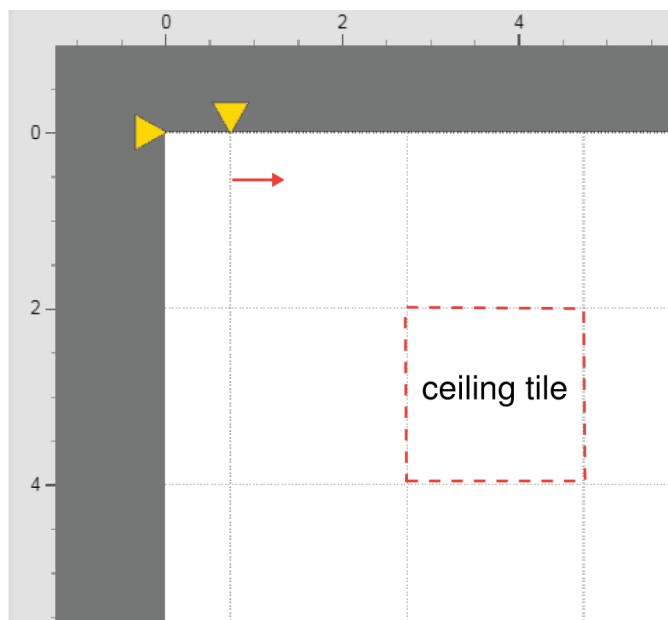

## Moving, rotating, and resizing objects

You can make changes to the devices in the Designer Coverage map.

### Coverage Map - Image

Enter edit mode by clicking Edit image above the workspace.

To exit, select anywhere outside of the image.

<b>Changing the opacity</b>	Adjust the transparency of the background image to provide more or less visibility in relation to the workspace and devices. A lower opacity value results in a more transparent image, while a higher value results in a darker image that matches the original file.
<b>Resizing the image</b>	Resize the image by dragging the corner of an image or entering a value into the properties panel. The ratio is locked so that changes to one dimension proportionally affect the other.
<b>Moving the image</b>	Change the position of a device in relation to the top-left corner of the workspace.
<b>Rotating the image</b>	Rotate the device to correctly position it in the room. Click and drag the handle to rotate the image to the desired position.  <b>Tip:</b> Hold the shift key to rotate in 45 degree increments.

### Coverage Map - Devices

<b>Adding a device</b>	Drag a device from the devices panel into the workspace.
------------------------	--

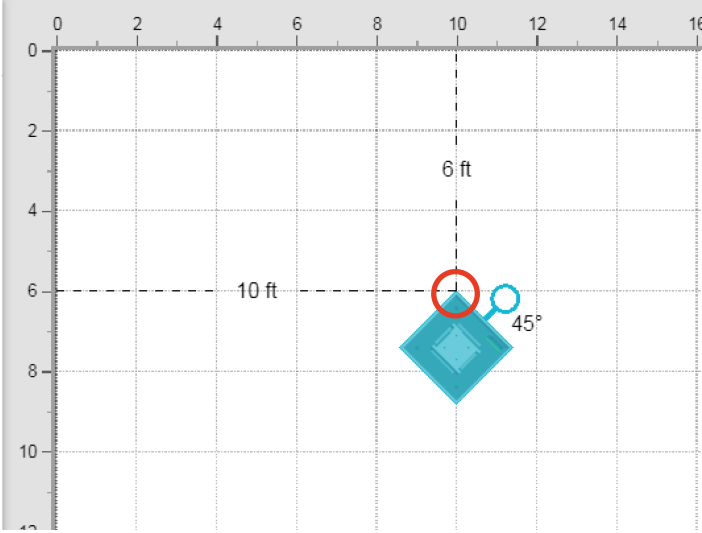
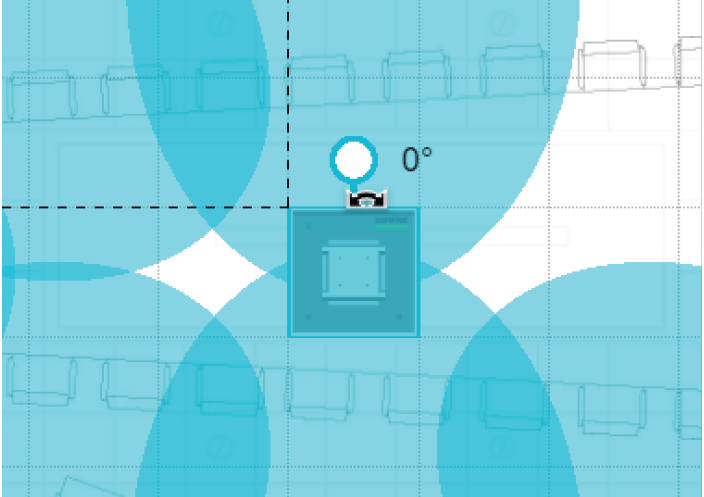
<b>Selecting a device</b>	Click on a device in the workspace to select it and to be able to edit its properties. To exit, click anywhere outside of the device.
<b>Removing a device</b>	Select it and press <b>Delete</b> or  .
<b>Positioning a device</b>	<p>Drag or nudge a device into a desired position on the workspace. The device properties displays its position in relation to the workspace 0,0 point.</p>  <p><b>Device reference point</b> <i>This point is used to measure coordinates.</i></p>
<b>Rotating a device</b>	<p>Click and drag the handle to rotate the device to the desired position.</p> <p><b>Tip:</b> Hold the shift key to rotate in 45 degree increments.</p> 

## Coverage Map - Channels

Select the channel to edit its properties. To exit, select anywhere outside of the channel.

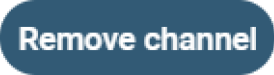
<b>Adding a channel</b>	Select the device and press Add channel
<b>Removing a channel</b>	Select the channel and press <b>Delete</b> or 
<b>Positioning a channel</b>	Drag or nudge a channel into a desired position. The channel properties displays its position in relation to the device and the workspace 0,0 point.
<b>Resizing a channel</b>	<p>The channel size is a combination of selectable width setting and automatically calculated properties based on layout specifications.</p> <ul style="list-style-type: none"> <li>Channel width: narrow (35 degrees), medium (45 degrees), or wide (55 degrees)</li> <li>Layout specifications: the channel changes shape due to a combination of talker height, device height, and distance from the microphone.</li> </ul>

## Coverage Map - Layers

With multiple devices in a workspace, it can become crowded when trying to select a device or channel. Use the Layers menu to the left of the workspace to select the device with which you want to work.

## Working with Virtual Devices

Designer lets system planners work off-line and off-site by using virtual devices. Virtual devices allow you to prepare microphone coverage, set device properties, adjust equalizer settings, and configure Dante audio routing, all without a connection to the hardware. To work with virtual devices, you must exit Live mode by selecting Live:

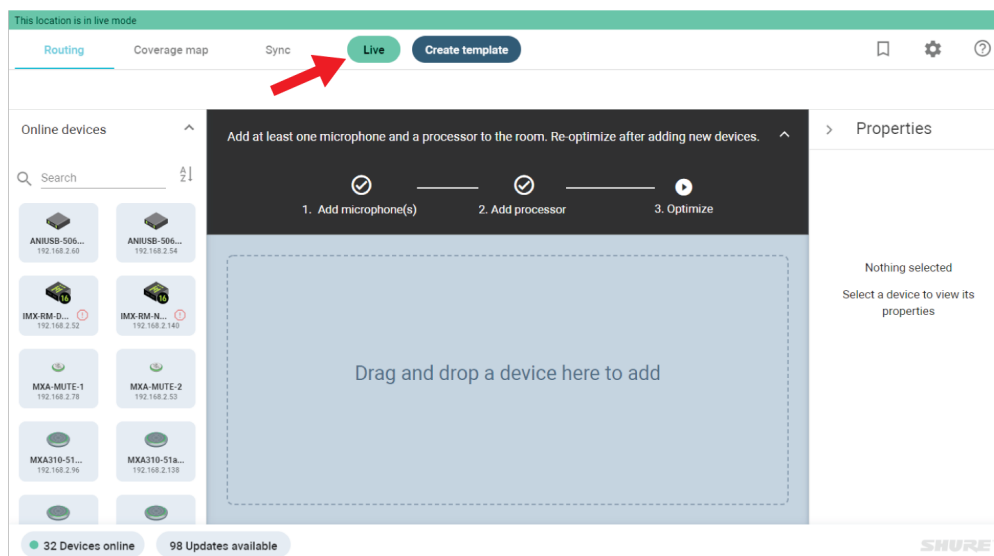

Virtual devices

After you complete your room or project, finish the job on-site by pushing your design to the discovered devices. You can then use Designer to fine-tune the properties on those devices in real-time.

---

## Pushing Designs to Discovered Devices

After creating your location and designing your audio coverage, you can leave Design mode and work in Live mode to push the settings out to the discovered devices.

1. From within your location, click on Overview to access the Live mode button.
2. Click Live mode to be able to push your design to the discovered devices.

The Live mode button is a toggle that turns Live mode on and off. The button turns green and a green banner across the top identifies that you are in Live mode.

To the left you see all of the discovered devices on your network that have not already been added to another one of your locations. Designer automatically discovers supported Shure devices on the same subnet and you can add cross-subnet devices by navigating to Online devices where you can add them by IP address.

If you have many devices, you can sort by device name, IP address, or device model. You should initially hover over a discovered device and click to identify it, ensuring that you are working with the correct one.

3. Associate your discovered devices with your virtual devices by dragging the discovered device to the virtual one.

Associating a discovered device with a virtual device does not actually push the virtual settings to the discovered devices until you click Synchronize and Push to devices.

You disassociate a device by clicking X.

4. When all of your associations have been made, click Synchronize to sync up the discovered devices with your virtual devices.

You can either push your virtual settings to the discovered devices or pull any settings from those discovered devices to overwrite the settings in your design.

**Note:** You can opt out of creating and pushing routes to discovered devices if you are using a 3rd party DSP, for example.

In live mode, you are making changes directly to your discovered devices and you can fine-tune them with Designer.

**Note:** Be aware that some of the changes you make can cause the audio to momentarily drop out.

## Synchronize, Push, and Pull

When you Synchronize and Push to devices, Designer overwrites everything on your discovered devices except for:

- network settings
- password and encryption settings
- Dante device name and channel name
- Dante routing when deselected on the Push dialog

When you Synchronize and Pull to design, Designer overwrites the devices in your design with the discovered device settings. Additionally, the pull may include some reference device settings that you cannot change and that would not be included in a push, for example, MAC address.

When the push or pull process is complete, your discovered devices are in sync with your virtual devices

# Saving Presets

When your devices are configured and set for a given location, you might want to save a specific design as a preset on all the devices. Presets are useful, for example, for a multipurpose or combinable room where the room can have different configurations. You can have multiple preset designs ready to apply when the room configuration changes.

To save settings as Presets:



1. Click  (Presets) in the upper right corner to open the **Device presets** pane. This shows you the presets for all devices in the location.
2. Select a preset slot.
3. Enter a name for the preset.
4. Click Save.

To apply presets to the devices:



1. Click  (Presets) in the upper right corner to open the **Device presets** pane. This shows you the presets for all devices in the location.
2. Select the preset that you want to apply.
3. Click Apply.

## Notes:

- Routing information is not saved in presets.
- You can create presets for either a location or for a specific device.
- Presets only apply to online devices, whether they are for a location or device-specific.
- If you are in Live mode, preset activity may cause the audio to momentarily drop out.
- Any changes made after applying presets results in an unsaved state. Save any new settings to a new preset slot or overwrite the old one with your new settings.
- Designer evaluates the current location's state based on the device preset slot names. If multiple devices in the same location do not share the same preset slot name, Designer determines that the location state is "Mixed". To resolve the mixed state, you must change the preset slot names on the devices separately so that they match.

# Event Log

To view the event log, click Event log from the main menu.

The event log provides a detailed account of activity within Designer. The log collects and time-stamps activity entries and retains them for the period of time that you specify in Settings, from 30 to 360 days. The Export feature creates a CSV (comma separated values) document to save and sort the log data.

To export the event log for a specific device, navigate to that device in Live mode and Click  (Settings) > General > Export Log. This feature creates a CSV (comma separated values) document of the log data.

Refer to the log file for details when troubleshooting or consulting with Shure Systems Support.



Severity Level	
Information	An action or event has been successfully completed.
Warning	An action cannot be complete, but overall functionality is stable.
Error	A problem has occurred that could inhibit functionality.

Log Details	
Event	Indicates the event type.
Description	Provides details on events and errors, including IP address and location where applicable.
Date	Date and time of the event.

**Tip:** Select a category heading to sort the log.

## MXA910

### Configuring Microphone Coverage for MXA910

Reference these steps to get up and running with the MXA910 ceiling array microphone. For in-depth information on microphone properties and best practices, see the [full MXA910 Ceiling Array User Guide](#).

#### Set Device Properties

Select the device and set the properties:

1. Enter a value for the device height (the distance between the floor and the microphone). By default, the device height matches the ceiling height, though you can adjust them independently.
2. Move and rotate the device to match your layout.

#### Position Microphone Coverage

1. Add channels by clicking Add channel above the workspace.
2. Enter the talker height by selecting a channel and providing the value in the Properties. This ensures accurate aiming.
3. Move channels to cover the appropriate areas:
  - Channels are independently selectable and can be moved anywhere within the maximum allowed coverage area. If dragged outside of this region, lobes turn red and revert back to the last acceptable position.
  - Position the channels by dragging or nudging them into place. Distance values to the device and to the workspace 0,0 are calculated in the properties panel.
  - Use the grid to measure the precise placement.

#### Adjust Channel Width

Independent width control makes it possible for some channels to capture individual talkers (narrow), while others cover multiple talkers (wide).

To change a channel width:

1. Select the channel
2. Choose a width setting from the pull-down menu. The width is calculated and displayed, based on the lobe location and heights entered for the device and talker.

**Width Settings:**

- Narrow (35°)
- Medium (45°)
- Wide (55°)

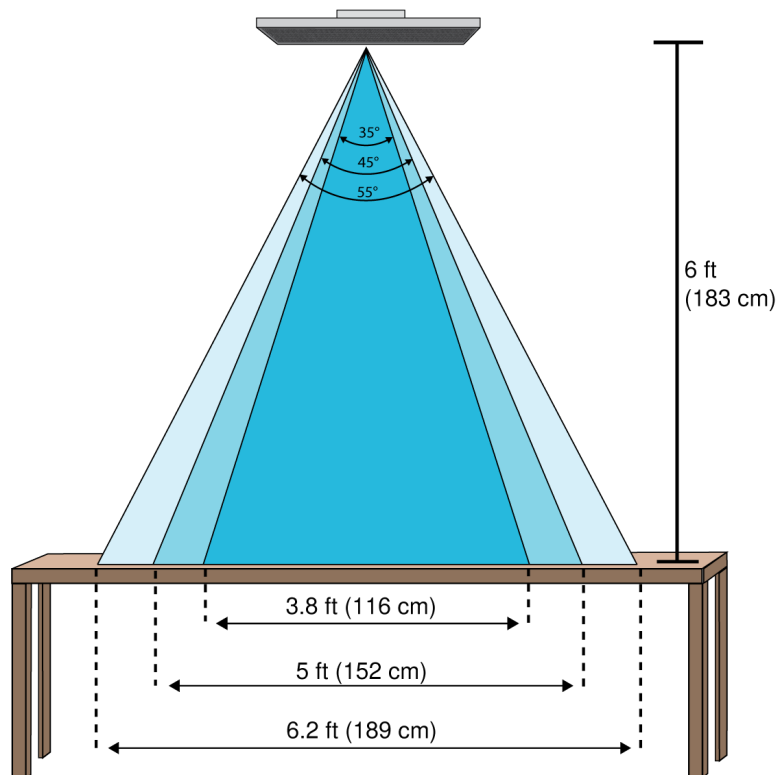

*Channel widths for the three settings with the microphone 6 feet above a table*

## Use Auto position

You can use Auto position to correctly position the lobe for a selected channel:

1. Select a channel.
2. Click Auto position.
3. Ensure that you have the correct channel selected and the talker height specified.
4. Click Listen. Designer listens and determines the correct position and width for the channel.
5. A confirmation dialog displays when Designer determines the correct position and width.

# Ceiling Array Microphone Placement

## Room Variables

Optimal microphone placement is determined by the seating arrangements and infrastructure. Follow these guidelines for the best possible results:

- In rooms with flexible furniture arrangements or multiple array microphones, use the microphone configuration tool in Designer to ensure that the coverage is adequate for all seating scenarios.
- The lobes should be pointed towards the front of each talker. Carefully consider placement in rooms where talkers may face a screen during a video conference.
- Avoid installing the microphone directly next to unwanted sound sources, such as air vents or noisy video projectors.
- Consider installing acoustic treatment to improve speech intelligibility in rooms that are too reverberant.

## Mounting Height for Ceiling Array Microphone

The maximum mounting height that can be set for the ceiling array microphone in Designer is 30 feet (9.14 meters). In a typical acoustic environment<sup>1</sup>, the microphone maintains an "A" rating based on the STIPA<sup>2</sup> (Speech Transmission Index for Public Address systems) international standard at distances up to 16 feet between the microphone and talker. In better acoustic environments, the STIPA "A" rating may extend beyond 16 feet.

Consider the following when determining a mounting height:

- The pickup pattern of the ceiling array is narrower than a shotgun microphone, and therefore it can be placed farther from the source than any other microphone. While Designer shows an ideal coverage zone for each channel, keep in mind that there is no specific barrier at which the audio degrades or gates off. Lobe sensitivity data is available for each width setting in the product specifications.
- Like all microphones, tonality changes as the distance from the source increases.
- The intelligibility scale helps to predict how the microphone will sound at a given height.
- The coverage area of the lobes increases at farther distances.

[1] Room conditions: RT60 (reverb time) = 500 ms @ 1kHz, A weighted room noise = 40dB SPL(A)

[2] IEC-602682-16 standard

## Intelligibility Scale

The intelligibility scale objectively compares the acoustic performance of the array microphone with a cardioid gooseneck microphone at various distances. This information is useful for predicting how the array microphone will perform at a given distance and to determine an ideal mounting height. The data in the intelligibility scale table is derived from measuring the microphones to meet an equivalent value from the **Speech Transmission Index IEC-602682-16 standard**.

## Distances With Equivalent Speech Transmission Index Values

Ceiling Array Microphone (Distance to Talker)	Cardioid Gooseneck Microphone (Distance to Talker)
6 ft (1.83 m)	3.75 feet (1.14 m)
8 ft (2.44 m)	5 feet (1.52 m)
10 ft (3.05 m)	6.25 feet (1.91 m)
12 ft (3.66 m)	7.5 feet (2.29 m)

Data was collected in a typical huddle room with the following measurements:

- **Reverberation decay time:** 500 ms @ 1kHz

- **Noise floor:** 40 dB SPL (A-weighted)

**Note:** These values are specific to the described room. In a well-controlled acoustic environment, the array microphone may perform with equivalent Speech Transmission Index values at even greater distances. In highly reverberant rooms, the performance is less predictable.

**A = Distance between array microphone and talker**

**B = Distance between cardioid microphone and talker**



*In this example, the acoustic performance of the array microphone mounted (A) feet from the talker matches the cardioid gooseneck microphone placed at a distance of (B) feet from the talker.*

## Using Autofocus™ to Improve Coverage

This microphone uses built-in Autofocus technology to fine-tune each lobe's position in real time, even if meeting participants lean back or stand up. You'll see the lobes moving in Designer's coverage map as participants shift positions. Autofocus only responds to in-room sound sources.

For best results with Autofocus, always route a reference source to the microphone's AEC Reference In channel. Even if you're only using direct outputs from the microphone and a different DSP, route a reference signal to the microphone's AEC Reference In channel to take full advantage of Autofocus.

## MXA710

Reference these topics to get up and running with the MXA710 linear array microphone. For in-depth information on microphone properties and best practices, see the [full MXA710 Microphone User Guide](#).

## How to Adjust Microphone Coverage

To control microphone coverage, use Designer. Microphone coverage is at the location level, meaning that there is one coverage map for all microphones in a location.

1. Go to [Your location] > Coverage map.
2. Drag your microphone onto the coverage map if it isn't there already. The first time you do this, you'll be prompted to choose an installation orientation. There are 4 options:
  - Wall horizontal
  - Wall vertical
  - Ceiling
  - Table

These coverage templates are designed and tested to fit most common installations.

3. Adjust each lobe's width (narrow, medium, or wide) and position as needed in the Properties panel. Adjust the microphone's position and orientation to match your room's layout.
4. Listen to each of your microphone's channels and adjust the lobe position, width, and gain as needed.

The solid blue line in each lobe represents where the coverage is the strongest. The edge of the blue coverage area for each lobe represents where the lobe's sensitivity reaches -6 dB.

Autofocus technology fine-tunes each lobe position in real time, even if meeting participants lean back or stand up.

## Tips for Great Coverage

- Click and drag lobes to change their position.
- Select the microphone and go to **Properties > Position** to change the installation type.
- Lobes can cover 1 talker or many talkers depending on width. Test and listen to your settings, and adjust as needed.
- **Ceiling installations:** For best coverage, avoid using narrow lobes.
- Lobes are bidirectional in some positions because of the microphone's pickup pattern.

## Using Autofocus to Improve Coverage

This microphone uses built-in Autofocus technology to fine-tune each lobe's position in real time, even if meeting participants lean back or stand up. You'll see the lobes moving in Designer's coverage map as participants shift positions. Autofocus only responds to in-room sound sources.

For best results with Autofocus, always route a reference source to the microphone's AEC Reference In channel. Even if you're only using direct outputs from the microphone and a different DSP, route a reference signal to the microphone's AEC Reference In channel to take full advantage of Autofocus.

---

## MXA310

Reference these topics to get up and running with the MXA310 table array microphone. For in-depth information on microphone properties and best practices, see the [full MXA310 Table Array User Guide](#).

## Table Array Microphone Placement

Each microphone has 4 channels that can be aimed independently, based on the seating arrangement. Each channel features independent polar patterns and additional channel settings, accessible through Designer .

Designer provides increased positioning flexibility over traditional conferencing microphones:

- Configurable pickup areas can be rotated and modified for the number of talkers.
- Network connectivity, device identification, and presets allow moving, adding and removing microphones with ease.
- Independent channels and automixing make Dante™ signal routing simple and flexible.
- Customized presets can be saved to immediately recall different room configurations.

## Seating Scenarios

Each channel can capture one or several talkers. In rooms with flexible furniture arrangements, microphones can be moved to cover various seating arrangements as long as they are plugged into the same network.

**Note:** Settings are saved on each microphone, and are retained when plugged into a different network port. Presets can be recalled and deployed through Designer, or through an external control system.

## Single-Microphone Applications (Multiple Channels)

With four independent channels and polar patterns, coverage can be customized to match the table shape, size, and seating arrangement. The automatic mixing feature helps reduce extraneous noise (such as typing or paper shuffling) from interfering with speech intelligibility on the far end.

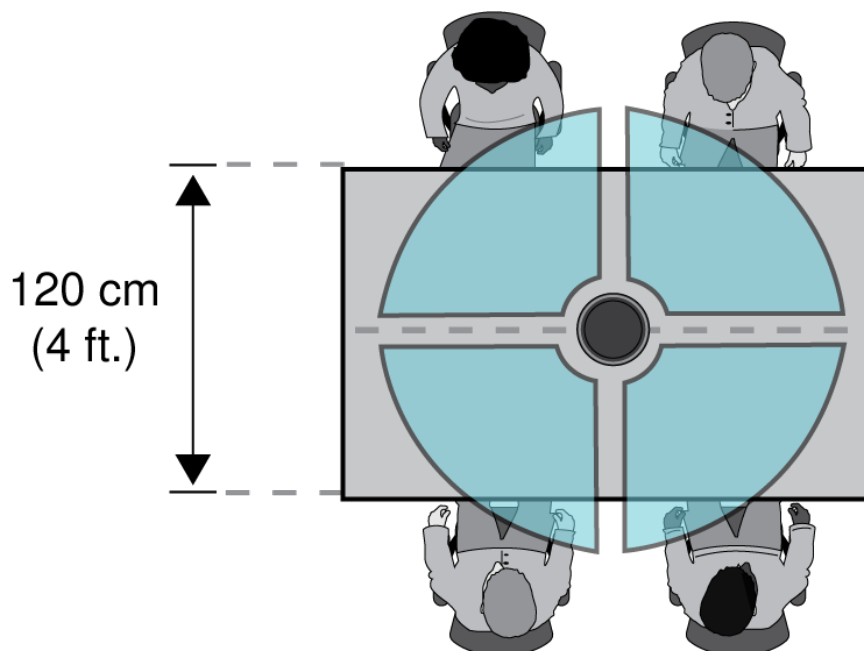

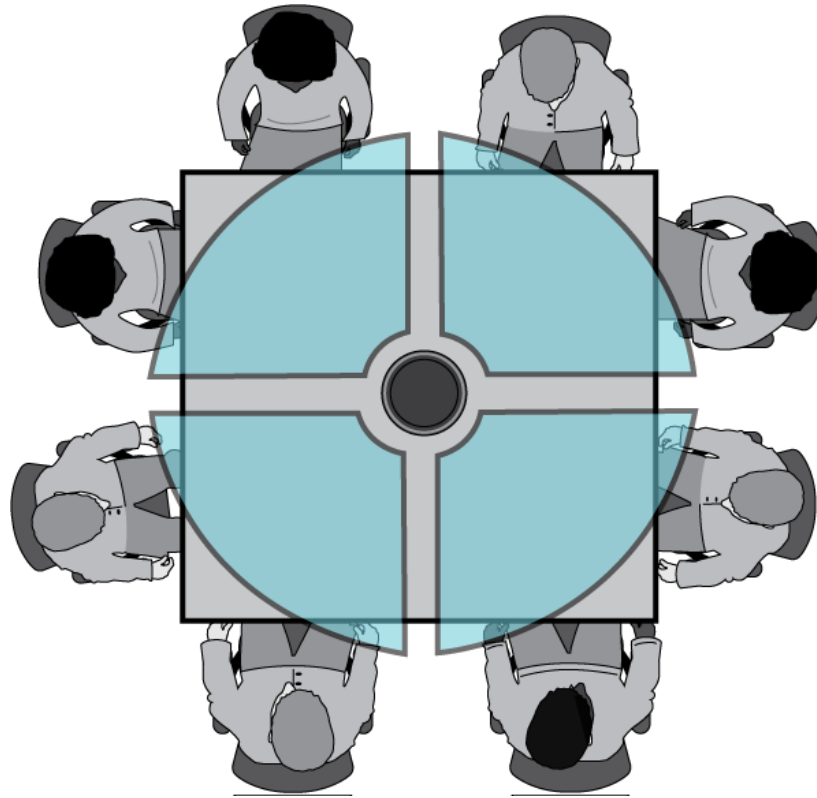

## Toroid Pattern Applications

The toroid pattern rejects sound from directly above the microphone to reduce noise from video projectors or other sources of unwanted sound. It is the simplest way to ensure equal coverage among all talkers, while retaining the benefits of the rejection provided by a directional polar pattern. When this pattern is used, the audio is sent over a single channel. Therefore, when automatic mixing is desired, configure the microphone to use multiple directional patterns instead of the toroid pattern.

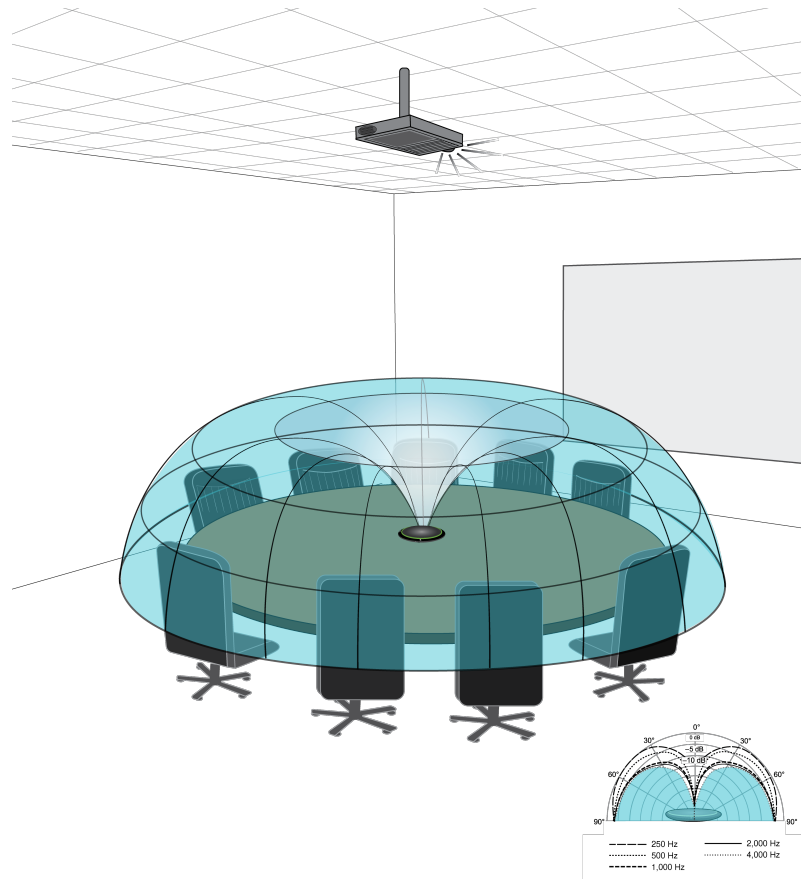

Noise from a ceiling-mounted projector is rejected, while all talkers are covered.

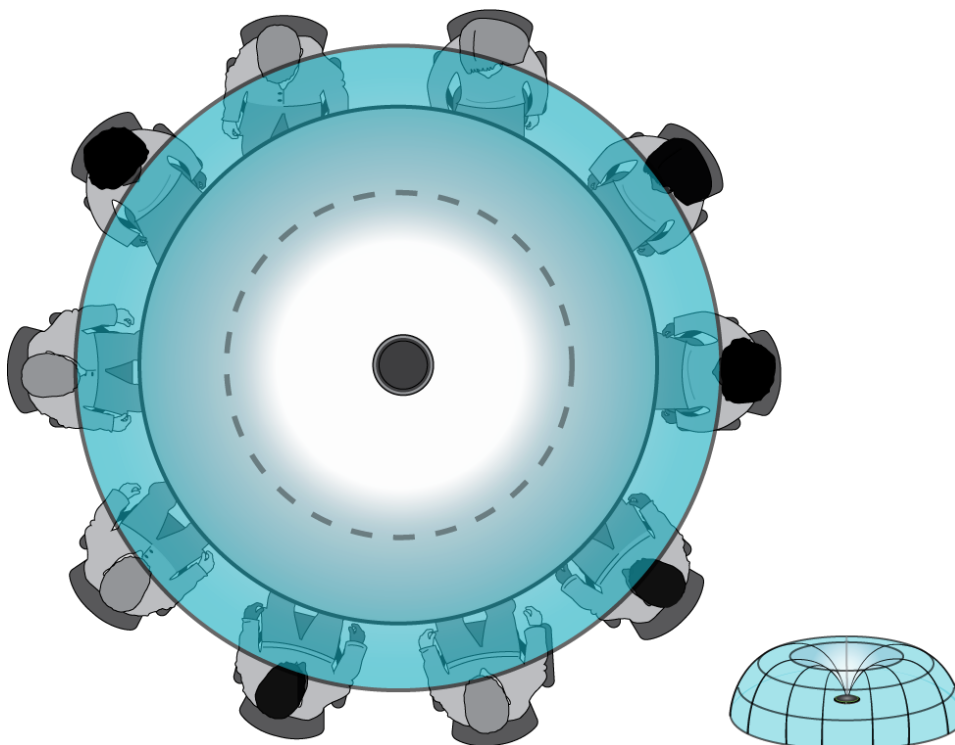



*For a table with a single microphone and more than 4 talkers, the toroid pattern to ensures that all voices are heard equally.*

## Coverage With Multiple Microphones

For large tables, a series of microphones captures all talkers. Place the microphones in the center of the table for balanced pickup and accurate aiming. For the best audio quality and clarity, use enough microphones so that each talker has their own channel.

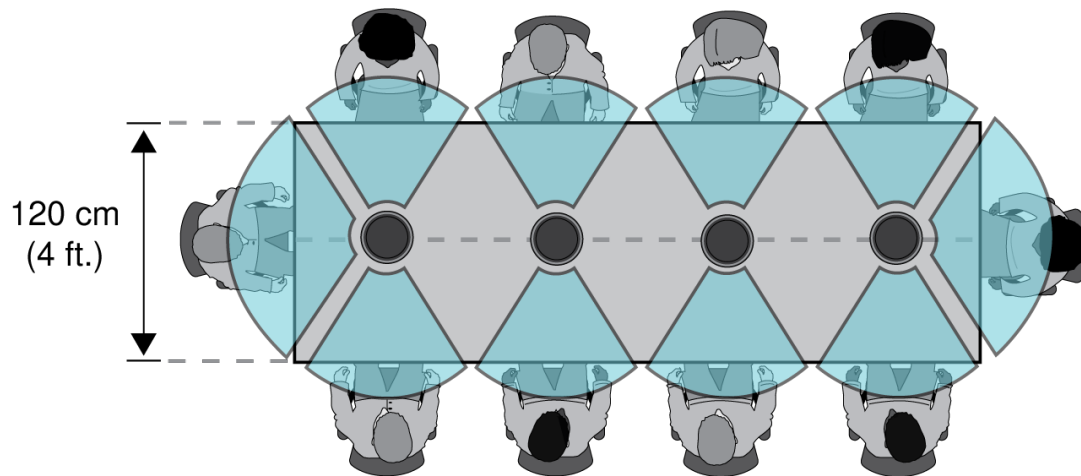

*A table with 10 people is covered by 4 microphones, with an independent channel for each person.*

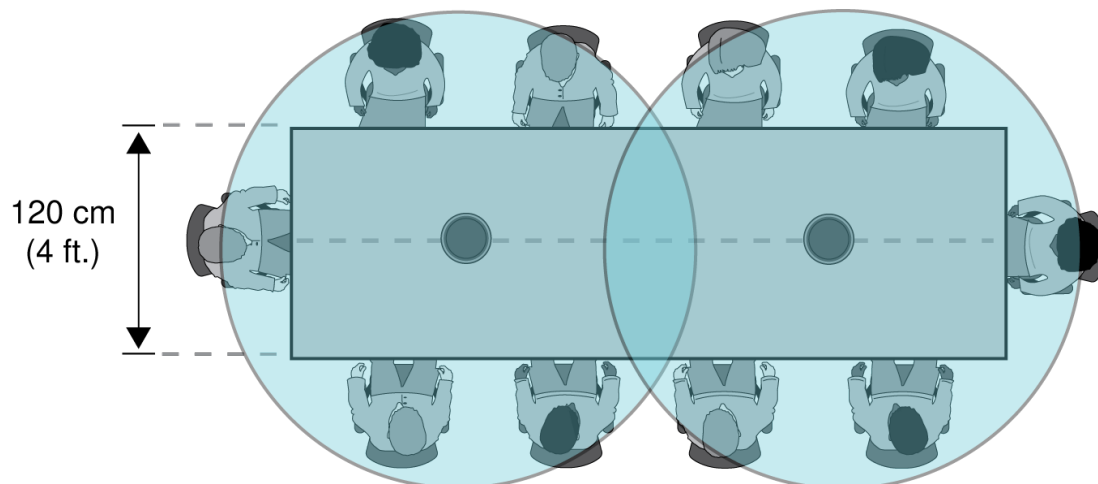

*For a large table with 2 microphones, place the microphones to cover equally sized areas. Use the Toroid or Omnidirectional setting to cover the entire table.*

# IntelliMix Room

Reference these topics to get up and running with IntelliMix Room. For in-depth information on this software and best practices, see the [full IntelliMix Room User Guide](#).

## Using Videoconferencing Software with IntelliMix Room

To connect IntelliMix Room to videoconferencing software, select **IntelliMix Room Echo Cancelling Speakerphone** as the speaker and the microphone in your videoconferencing software. Do the same thing in the computer's sound settings.

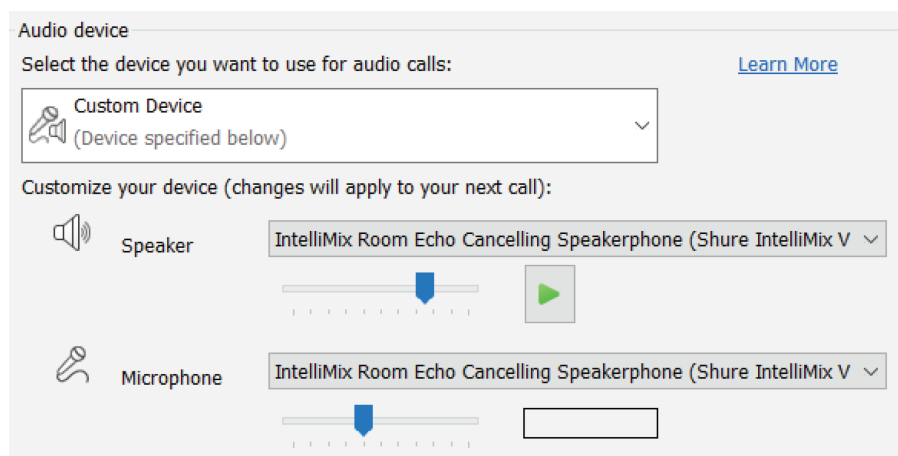

The microphone setting sends signals to the videoconferencing software from any microphone connected to IntelliMix Room.

The speaker setting sends a far-end signal from the videoconferencing software to IntelliMix Room. This is how IntelliMix Room gets an AEC reference and a signal for local sound reinforcement.

If you choose a different source as the speaker, you won't be able to get far-end audio from the videoconferencing software into IntelliMix Room to use as an AEC reference.

## Routing Microphone Signals to the DSP

To route your microphone's signal to IntelliMix Room for processing, use Designer.

This example reflects a small conference room with:

1. MXA310 using 4 channels
2. Computer with 8-channel IntelliMix Room and videoconferencing software installed
3. Display and camera

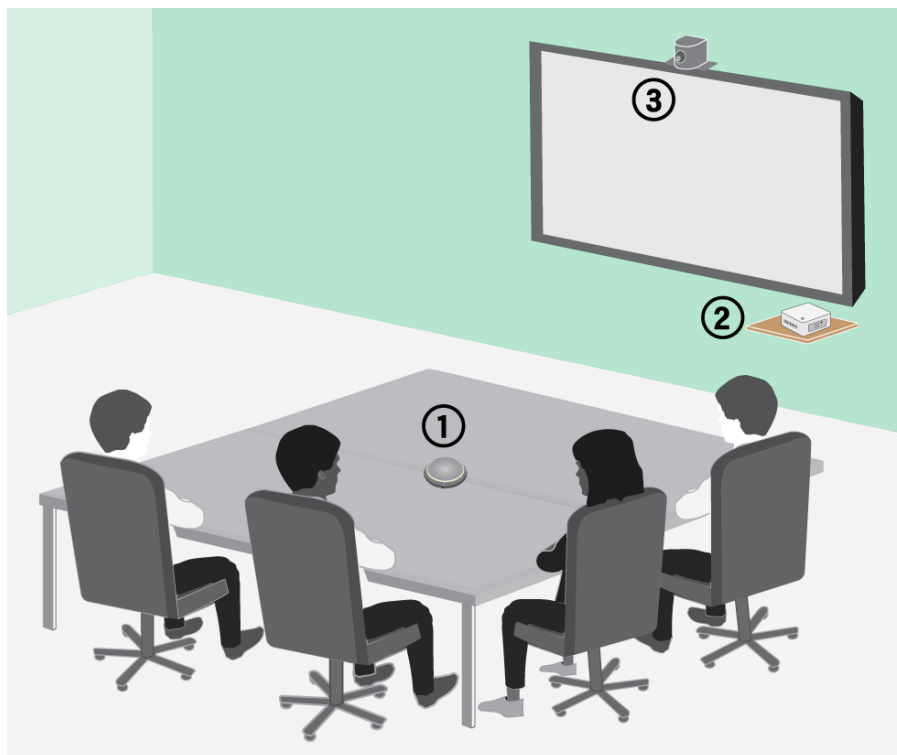

#### To route signals to the DSP:

1. Create a location in Designer. Add the MXA310 and IntelliMix Room installation to the location from the Online devices list.
  - Both devices must be in the same location to route audio between them.
2. Open the location and go to Routing. This page creates Dante audio routes between Shure devices.
3. Drag and drop from the MXA310's 4 outputs to any 4 inputs on IntelliMix Room. It's best to use the individual channel outputs from the microphone and not the automix output, because IntelliMix Room has its own automixer.

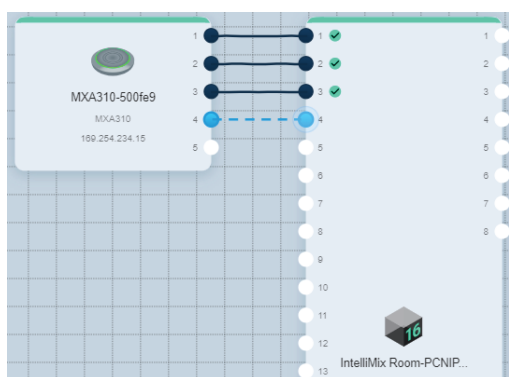

4. Click Optimize audio. This feature automatically changes microphone and DSP settings to work best for your connected devices. You can customize settings further, but optimize audio gives you a good starting point.
5. Open IntelliMix Room's device configuration window. From here, you can adjust DSP settings and route the signal to other sources. Check that your mic inputs are using the AEC reference you want to use.
6. To send your signal to other sources, go to Matrix mixer.
  - To send the automix signal to videoconferencing software, route to the virtual audio output.

- To send the automix signal to other Dante sources, route to the appropriate Dante output. Use Dante Controller to route IntelliMix Room Dante outputs to non-Shure devices.

**Note:** If you're using a non-Shure Dante microphone, use Dante Controller to route the near-end signal to IntelliMix Room.

---

## P300

Reference these topics to get up and running with the P300 IntelliMix® Audio Conferencing Processor. For in-depth information on this device and best practices, see the [full P300 IntelliMix® Audio Conferencing Processor User Guide](#).

## Pre- and Post-Gain Metering

The 2 metering modes allow you to monitor signal levels before and after the gain stages.

### Input Metering

- **Pre-gain:** Displays the pre-fader signal level. If signals are too low or clipping, adjust them at the source.
- **Post-gain:** Displays the post-fader signal level, so the meters reflect gain adjustments on input faders. This meter does not include automatic gain control or any other processing.

### Output Metering

- **Pre-gain:** Displays signal levels after input gain has been applied, but before the output faders. This meter includes input faders, digital signal processing blocks, automixing, and crosspoint gain.
- **Post-gain:** Displays the post-fader signal level sent to each output. This meter includes gain adjustments made on the output faders.

## Setting Up Mute Sync on the MXA310 and P300

Use this setup to mute the P300 by pressing the mute button on the MXA310. In the P300's signal chain, muting happens after the DSP so that the AEC stays converged.

1. Open the P300 in Designer and go to Inputs.
2. On any channel strip, select Logic enable. This enables logic on all channels.
3. Open the MXA310 in Designer and go to Settings > Logic control.
4. Set the Mute control function to Logic out.
5. Go to Lights. Set the style to Ring.

---

## ANIUSB

Reference these topics to get up and running with the ANIUSB-MATRIX Audio Network Interface. For in-depth information on this device and best practices, see the [full ANIUSB-MATRIX User Guide](#).

## Dante Transmit Flows

This device supports up to **two transmit flows** and **two receive flows**. A single flow consists of up to **four channels**, through either a unicast or multicast transmission.

- A **unicast flow** is a point-to-point connection between two devices, supporting up to four channels per flow.
- A **multicast flow** is a one-to-many transmission, which supports sending up to four channels to multiple receiving devices across the network.

## Shure Device Applications

This device can connect with up to two Dante devices.

The Shure MXA310, ANI22, ANIUSB-MATRIX and ANI4IN support multicast transmission. This means that flows can transmit to multiple devices -- as many as the network can support. If using unicast flows, each of these devices can connect with up to two Dante receiver devices.

The Shure ANI4OUT connects with up to two Dante transmitter devices.

## Setting Up Mute Sync on the MXA310 and ANIUSB-MATRIX

Use this setup to mute the ANIUSB-MATRIX by pressing the mute button on the MXA310. In the ANIUSB-MATRIX's signal chain, muting happens after the inputs.

### Designer 4.2 and newer:

1. Add the ANIUSB-MATRIX and MXA310 to the same location in Designer.
2. Select Optimize. Designer optimizes microphone and DSP settings for your equipment combination, including turning on mute synchronization.

### Designer 4.1.x and older

1. Open the ANIUSB-MATRIX in Designer and go to Inputs.
2. On any channel strip, select Logic enable. This enables logic on all channels.
3. Open the MXA310 in Designer and go to Settings > Logic control.
4. Set the Mute control function to Logic out.
5. Go to Lights. Set the style to Ring.

---

## Microflex™ Networked Ceiling Loudspeaker

Reference these topics to get up and running with Microflex Networked Ceiling Loudspeaker. For in-depth information on loudspeaker properties and best practices, see the [full Networked Ceiling Loudspeaker User Guide](#).

## Routing Signals to the Loudspeaker

To route audio to the loudspeakers, you can use Shure Designer software or Dante Controller software.

1. In Designer, create a location that has all loudspeakers and any Dante audio sources.
  - Shure's P300 or ANI processors are easy ways to manage Dante signals from many sources.
2. Go to Routing. Drag and drop from the audio source output to the loudspeaker input to create Dante routes.

If you're sending a signal from one loudspeaker to another, use a pre-DSP signal.

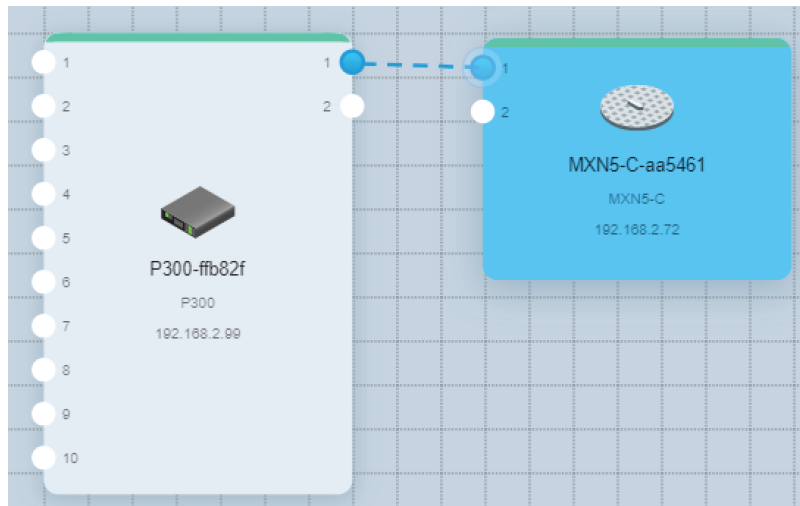

## Routing Signals to Multiple Loudspeakers

In rooms with multiple loudspeakers installed, you can route a signal from one loudspeaker to another using the Dante output channel, or you can route the signal to each loudspeaker individually.

### Routing to Each Loudspeaker Individually

**Use this method when:**

- Signal comes from device with Brooklyn II chip, such as a P300 **or**
- Signal comes from device with Ultimo chip transmitting in multicast

[Learn more about Dante flows in our FAQs](#) or from [Audinate](#).

If you're using a Shure P300 or other devices with high unicast Dante flow limits, route a signal to each loudspeaker individually using Designer or Dante Controller.

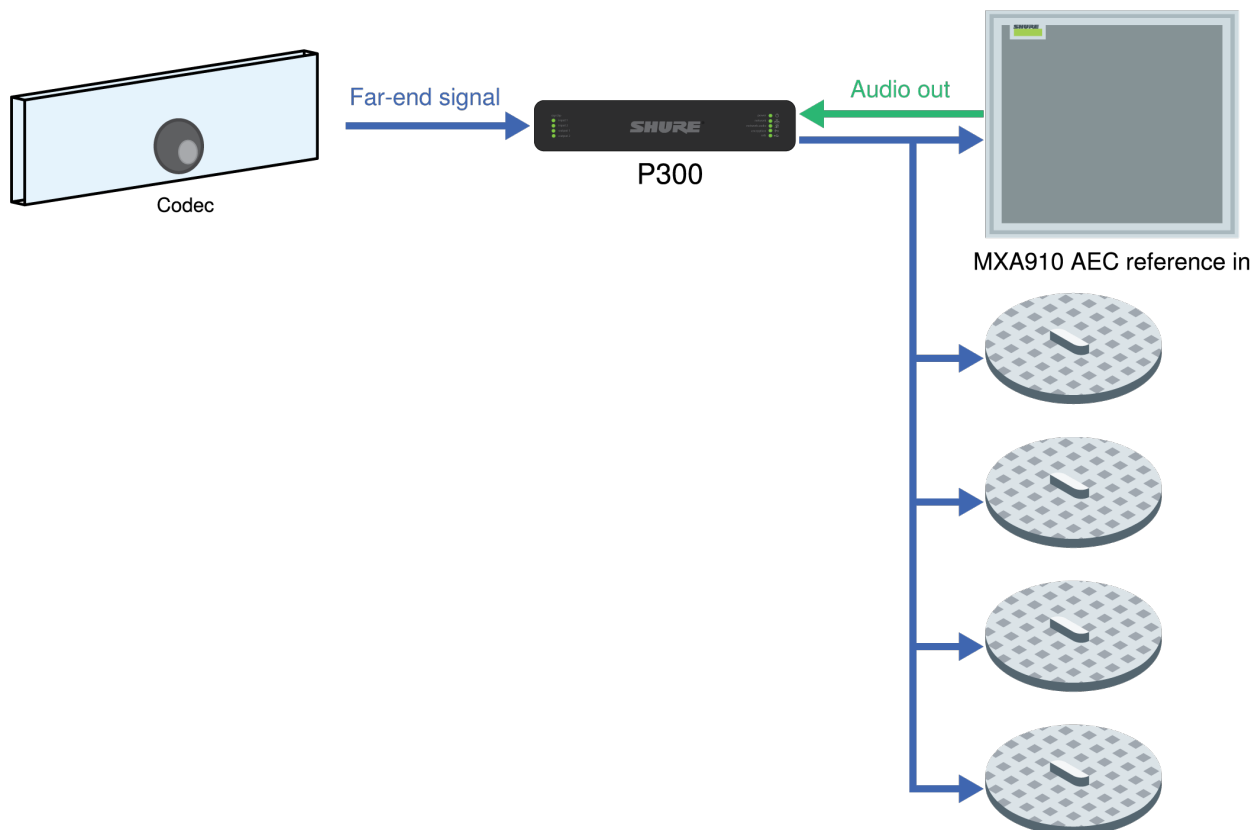

## Routing Signals from Loudspeaker to Loudspeaker

### Use this method when:

- Signal comes from device with Ultimo chip transmitting in unicast, such as Shure ANI

Learn more about Dante flows in our [FAQs](#) or from [Audinate](#).

If you encounter unicast Dante flow limits, route from one loudspeaker to another using the Dante output channel.

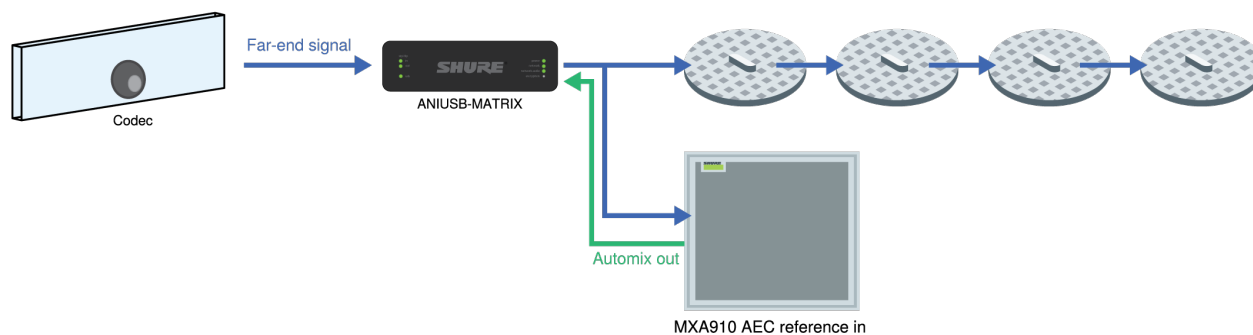

1. In Designer, put all of the loudspeakers and other devices you want to route to in the same location.
2. Route the signal to the first loudspeaker.
3. Open the first loudspeaker's configuration window in Designer.
4. Choose Pre-DSP in the Dante output signal menu. This prevents DSP blocks from stacking on top of each other in the signal chain.

- Use Designer or Dante Controller to route the signal from the first loudspeaker to the next one. Repeat this process for each additional loudspeaker.

## Network Mute Button

Reference these topics to get up and running with the MXA Network Mute Button. For in-depth information on mute button properties and best practices, see the [full MXA Network Mute Button User Guide](#).

### How the Network Mute Button Works

The network mute button is a simple muting solution for rooms with no microphone on the table, for when the microphone has no mute button, or for when you need another way to control muting. Use Shure Designer software to link mute buttons to a compatible device.

You can link mute buttons to Shure microphones, DSPs, or audio network interfaces. When you link mute buttons to a DSP or audio network interface, any supported devices connected to the DSP or audio network interface match the button's mute status.

For example, in this room, 2 mute buttons are linked to a P300. Two MXA910 microphones are connected to the P300, and the P300 sends the near-end signal to a soft codec running on a computer. When you press one of the mute buttons, all connected devices show the correct mute status. The signal gets muted at the best point in the signal chain for DSP performance.

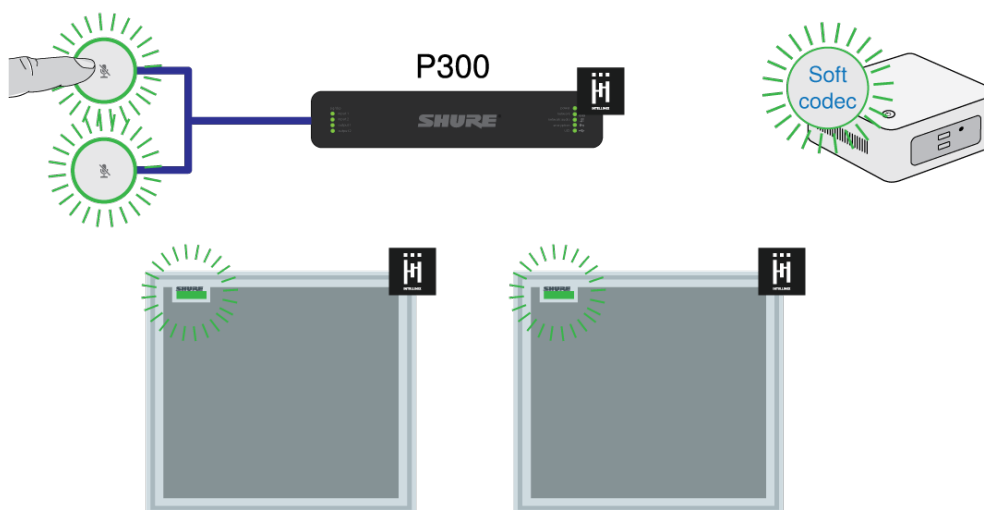

### Linking Mute Buttons to a Device

Use Designer to link one or more mute buttons to a device. When you link the mute button to Shure devices with IntelliMix DSP, the AEC stays converged to deliver the best performance.

In most rooms, all mute buttons control muting for the same device. To set this up:

- Create a location in Designer.
- Add the mute buttons and other Shure devices in the room to the location.
- Open the location and go to Routing.

From here, you can link mute buttons to compatible devices.

- Drag and drop from each of the mute buttons to the device you want to mute.



In rooms with at least 1 microphone and 1 audio processor, you can use the Optimize workflow to let Designer automatically create mute control routes for you.

Use these guidelines to choose what device to link the mute button to:

**Microphone with IntelliMix DSP (MXA910 or MXA710), no separate DSP:** Link the mute buttons to the microphone.



**One or more microphones connected to separate DSP (P300, IntelliMix Room, or ANIUSB-MATRIX):** Link the mute buttons to the DSP.

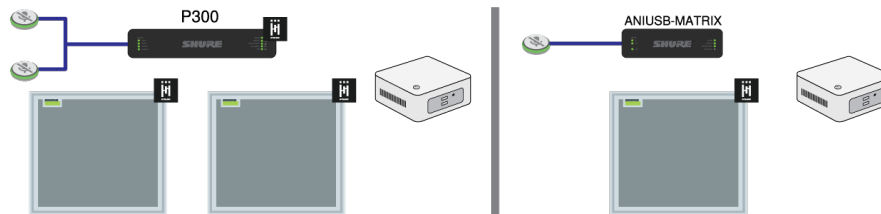

**Microphone connected to third-party DSP:** If using the microphone's IntelliMix output, link the mute button to the microphone. If using the microphone's direct outputs, use third-party command strings to set up muting.