

LA7.16i

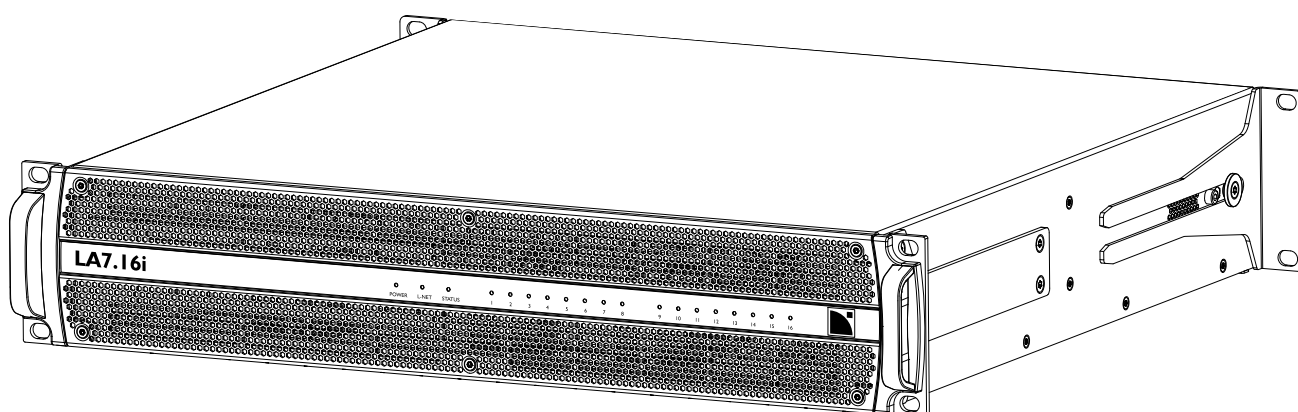

owner's manual (EN)



Document reference: LA7.16i owner's manual (EN) version 1.3

Distribution date: March 2, 2023

© 2023 L-Acoustics. All rights reserved.

No part of this publication may be reproduced or transmitted in any form or by any means without the express written consent of the publisher.











Contents

Safety.....	5
Important safety instructions.....	5
Symbols on the product.....	7
Introduction.....	8
LA7.16i amplified controller.....	8
How to use this manual.....	9
Revision history.....	9
System components.....	10
Technical description.....	11
Main features.....	11
Internal components.....	11
Front and rear panels.....	11
Signal processing and amplification.....	12
Signal inputs.....	12
DSP architecture.....	14
Power supply and amplifier section.....	14
Speaker outputs.....	14
Speaker protection.....	15
Monitoring and control.....	15
User interface.....	15
L-NET remote control network.....	15
Inspection and preventive maintenance.....	16
How to do preventive maintenance.....	16
CHK - External structure.....	16
CHK - Cleanness.....	17
CHK - Normal start-up sequence.....	17
CHK - Network functionalities and firmware.....	17
Installation.....	18
Mounting.....	18
Ventilation.....	19
General Purpose I/O (GPIO).....	20
Connecting to AC mains.....	21
Electrical specifications.....	21
Planning the power of the electrical generator.....	21
Power cord.....	22

Plugging the amplified controller.....	22
Power consumption.....	22
Heat power calculation.....	23
24 V DC Input.....	23
Audio and network cabling.....	24
Connection panels.....	24
Analog audio.....	27
Digital audio.....	28
L-NET/AVB.....	29
Speaker.....	30
Connector references.....	31
Operation.....	32
Powering on/off.....	32
Interpreting the front panel LEDs.....	32
L-NET.....	32
STATUS.....	33
Meters.....	33
Other operations.....	34
Specifications.....	35
General.....	35
Input signal distribution.....	37
Latency.....	37
AVB.....	37
Automatic fallback option.....	38
Remote control and monitoring.....	38
Physical data.....	38
Appendix A - Glossary.....	40
Appendix B - Approvals.....	41

Safety

Important safety instructions

- 
Inspect the product before operation.
 If any sign of defect or damage is detected, immediately withdraw the product from use for maintenance.
- 
Perform preventive maintenance at least once a year.
 Refer to the preventive maintenance section for a list of actions and their periodicity.
 Insufficient upkeep of the product can void the warranty.
- 
Verify the electrical conformity and compatibility of the mains supply.
 Only connect the product to an AC power outlet rated 100-240 V, 50-60 Hz, with the following current values:
 100-120 V: 30 A
 220-240 V: 16 A
WARNING: The product is of Class 1 construction and shall be connected to a mains socket outlet with a Protective Earth connection.
- 
When the product is used in a three-phase circuit, verify the electrical conformity and compatibility of the three-phase circuit.
 Verify that the three phases work, and balance the loads between the three phases.
 Verify that the neutral and earth work.
 Never try to emulate a 230 V circuit connecting an apparatus to two live wires of a 120 V three-phase circuit.
 Never try to emulate a 200 V circuit connecting an apparatus to two live wires of a 100 V three-phase circuit.
- 
The power supply feeding LA7.16i must be equipped with circuit breakers meeting the following requirements:
 The circuit breaker must operate on each phase separately (no mechanical link between phases).
 Use these references, or equipment with equivalent characteristics:
 100-120 V: 30 A, Schneider Electric Square D 30A QO (in North America), or Mitsubishi CP30-BA-M (in Japan).
 220-240 V: 16 A, Type C.
 Circuit breakers of different characteristics could trip in case of short-term, high current draw, because they do not match LA7.16i Fuse Protect algorithms.
- 
Electrical generator
 You must power on the generator before powering on the product.
- 
Terminals marked with the lightning flash symbol are HAZARDOUS LIVE.
 The external wiring connected to these **terminals** requires installation by an **instructed person** or the use of ready-made leads or cords.
 Never attempt to touch any exposed speaker wiring while the product is operating: first disconnect the connector from the product.
 Mute all output channels before connecting a speaker to an amplified controller.
 Do not connect a speaker output in parallel or series with any output of another amplified controller.
 Do not connect the speaker outputs to any other voltage source, such as a battery, power mains, or power supply, regardless of whether the amplified controller is turned on or off.
- 
- 
Never incorporate equipment or accessories not approved by L-Acoustics.
- 
Read all the related PRODUCT INFORMATION documents shipped with the products before exploiting the system.
- 
Intended use
 This system is intended for use by trained personnel for professional applications.

 **As part of a continuous evolution of techniques and standards, L-Acoustics reserves the right to change the specifications of its products and the content of its documents without prior notice.**

Check www.l-acoustics.com on a regular basis to download the latest document and software updates.

 **Beware of sound levels.**

Do not stay within close proximity of loudspeakers in operation.

Loudspeaker systems are capable of producing very high sound pressure levels (SPL) which can instantaneously lead to permanent hearing damage to performers, production crew and audience members. Hearing damage can also occur at moderate level with prolonged exposure to sound.

Check the applicable laws and regulations relating to maximum sound levels and exposure times.

 **Beware of over power risks.**

Only use compatible loudspeakers with appropriate presets to avoid damage to the loudspeakers.

 **Do not use the product outside its operating temperature range.**

The product operates at a room temperature between -5 °C / 23 °F and 50 °C / 122 °F.

Do not expose the product to direct sun.

 **Do not expose the product to extreme conditions.**

Do not expose the product to moisture (rain, mist, sea spray, steam, humidity, condensation...) or excessive heat (direct sun, radiator...) for a long period of time.

For more information, refer to the **Products weather protection** document, available on the website.

 **Only use the product in a conformed electro-magnetic environment (EN55035 standard).**

 **Avoid radio interference.**

This product has been tested and complies with the limits indicated in the EMC directive (Electro Magnetic Compatibility). These limits are designed to provide reasonable protection against harmful interference from electrical equipment, but it cannot be guaranteed that interference will never occur.

 **Product disconnection**

To completely disconnect this product from the mains, disconnect the power supply cord plug from the mains socket outlet.

 **Power supply cord and socket accessibility**

The main plug of the power supply cord shall remain easily accessible.

The mains socket outlet shall be easily accessible.

 **Read the maintenance section of this document before servicing the product.**

 **Contact L-Acoustics for advanced maintenance.**

Any unauthorized maintenance operation will void the product warranty.

Before sending a product to L-Acoustics for maintenance, save all user presets to files using LA Network Manager.

 **Shipping**

Use the original packaging for shipping the product, unless it is mounted in a rack with the front and rear panels fixed to the rack, as described in this manual.

Symbols on the product



Explanation of graphical symbols



The lightning flash with arrowhead symbol within an equilateral triangle is intended to alert the user to the presence of uninsulated "dangerous voltage" within the product's enclosure that may be of sufficient magnitude to constitute a risk of electric shock to persons.



The exclamation point within an equilateral triangle is intended to alert the user to the presence of important operating and maintenance instructions in the literature accompanying the product.



Do not open unless authorized. This symbol indicates the presence of electrical shock hazards. It also indicates that no maintenance performed by the end user requires access to internal components.



This marking indicates that this product should not be disposed of with other household waste throughout the EU. To prevent possible harm to the environment or human health from uncontrolled waste disposal, recycle it responsibly to promote the sustainable reuse of material resources. To return your used device, please use the return and collection systems or contact the retailer where the product was purchased. They can take this product for environmentally safe recycling.

Introduction

LA7.16i amplified controller

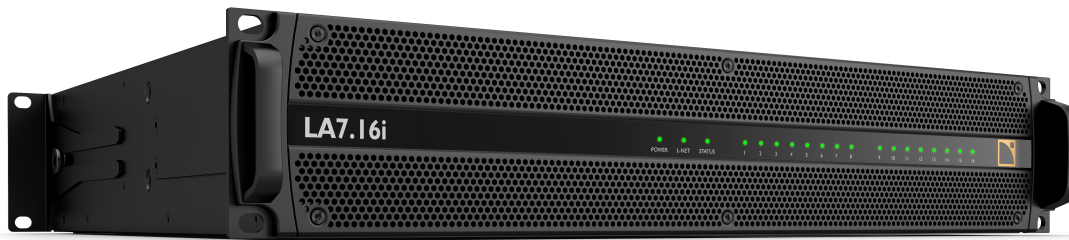

LA7.16i is a 16 x 16 architecture amplified controller dedicated to permanent installations which brings a unique solution to applications that can benefit from high discretization amplification and processing. Each of the 16 output channels can deliver up to 1300 W at 8 ohms or 1100 W at 4 ohms, making LA7.16i capable of driving most L-Acoustics loudspeakers in large quantities. This combination of high channel density and power capability makes LA7.16i the perfect partner for medium to large-sized permanent installations.

The flexible feature set offered by LA7.16i benefits all types of integration projects, involving any system that uses diverse combinations of loudspeaker elements, such as theaters and performing arts centers. Deployments requiring individual channel processing, such as L-ISA hyperreal and immersive hyperreal systems, can exploit the 16 discrete inputs and outputs. Additionally, line sources can benefit from single element discretization, leveraging Autofilter to deliver even more uniform coverage across the audience space.

Commonly an amplifier power supply unit (PSU) and its output channels are linearly proportioned to drive the most demanding and power-hungry loudspeakers, typically subwoofers. However, most systems are composed of a varied mix of loudspeaker types, passive and active, small and large, sub and full-range, and often with temporal offsets in the signals. This leads to unique power delivery needs, at specific times, for each amplifier channel, reducing the overall demand on the PSU. LA7.16i integrates L-SMART, a suite of advanced power management technologies, developed by L-Acoustics, which use predictive modeling algorithms to manage the PSU and the individual amplification channels. Hardware sensors feedback data which is analyzed by the DSP to match the real-time needs of the loudspeaker system being driven. The PSU can provide extremely high short-term peak power and 7000 W for longer hold times, and this energy is delivered dynamically and intelligently to the advanced Class-D output stages, assuring optimum system performance.

Packaged in a compact 2U chassis for efficient use of rack space and lower cost of integration, LA7.16i reduces the associated carbon footprint of any L-Acoustics sound system, supporting our constant effort for greater sustainability. It incorporates features tailored for installation applications, such as loudspeaker monitoring, protection, and management, GPIO's, terminal block connectors, and a backup 24 V DC input enabling the DSP card to continue functioning if mains power is lost. Smart mains current limiting and circuit breaker emulation are also included. The Milan-certified LA7.16i supports Milan-AVB seamless network redundancy and is remotely controlled and monitored using LA Network Manager.

How to use this manual

The LA7.16i owner's manual is intended for all actors involved in the system design, implementation, preventive and corrective maintenance of the LA7.16i product. It must be used as follows:

1. Read the technical description for an overview of all product elements, their features, and their compatibilities.
 - [Technical description](#) (p.11)
2. Before installing the product, perform mandatory inspections and functional checks.
 - [Inspection and preventive maintenance](#) (p.16)
3. To deploy the product, follow the step-by-step installation instructions and refer to the cabling schemes.
 - [Installation](#) (p.18)
 - [Audio and network cabling](#) (p.24)
4. To configure the settings and parameters of the product, follow the step-by-step operation instructions.
 - [Operation](#) (p.32)

As part of a continuous evolution of techniques and standards, L-Acoustics reserves the right to change the specifications of its products and the content of its documents without prior notice.

Check www.l-acoustics.com on a regular basis to download the latest document and software updates.





Contact information

For information on advanced corrective maintenance:

- contact your Certified Provider or your L-Acoustics representative
- for Certified Providers, contact the L-Acoustics customer service: customer.service@l-acoustics.com (EMEA/APAC), laus.service@l-acoustics.com (Americas).

Symbols

The following symbols are used in this document:

-  This symbol indicates a potential risk of harm to an individual or damage to the product. It can also notify the user about instructions that must be strictly followed to ensure safe installation or operation of the product.
-  This symbol indicates a potential risk of electrical injury. It can also notify the user about instructions that must be strictly followed to ensure safe installation or operation of the product.
-  This symbol notifies the user about instructions that must be strictly followed to ensure proper installation or operation of the product.
-  This symbol notifies the user about complementary information or optional instructions.

Revision history

version number	publication date	modification
1.0	June 2022	Initial version.
1.1	Nov. 2022	Added recommendations on using multicore loudspeaker cables.
1.2	Nov. 2022	Fixed product name issue.
1.3	Mar. 2023	Various issue fixes and improvements.

System components

Powering and driving system

LA7.16i Amplified controller with DSP, preset library and networking capabilities

Loudspeaker enclosures

! Refer to the user documentation of the loudspeaker systems for detailed instructions about the enclosures and their connection to the amplified controllers.

Cables

DOE cables Dual AVB Network cable CAT6A, etherCON (black = primary network, red = secondary network)
 Come in different sizes: DOE2 (2 m / 6.6 ft), DOE45 (45 m / 147.6 ft), and DOE100 (100 m / 328.1 ft)

powerCON 32A Power supply cord with powerCON 32A connector (1.20 m / 3.9 ft).
 Comes in different versions: EU, CN, INT, US.

Software applications

Soundvision 3D acoustical and mechanical modeling software

LA Network Manager Software for remote control and monitoring of amplified controllers

i Refer to the **Soundvision** help.
 Refer to the **LA Network Manager** help.

System component illustrations

Cables

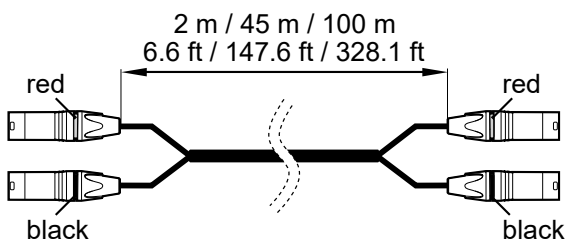

DOE cables

Software applications

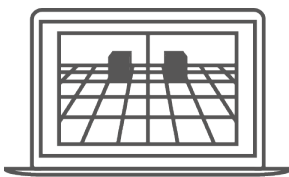

Soundvision



LA Network Manager

Technical description

Main features

Internal components

The core of the LA7.16i is a Gen. 5 dual DSP engine driving 16 channels of amplification from 16 AVB streams of up to eight channels, and one AES/EBU input (two channels) or one analog input (one channel). LA7.16i features a flash memory for preset storage and management, high performance A/D-D/A converters for audio signals, a universal Switched Mode Power Supply (SMPS) with PFC (Power Factor Correction), and a dual-port Ethernet Gigabit interface.

Front and rear panels

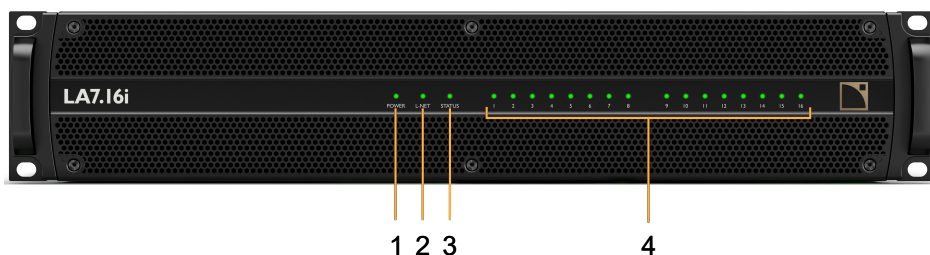

1. power LED
2. L-NET LED
3. status LED
4. signal LEDs

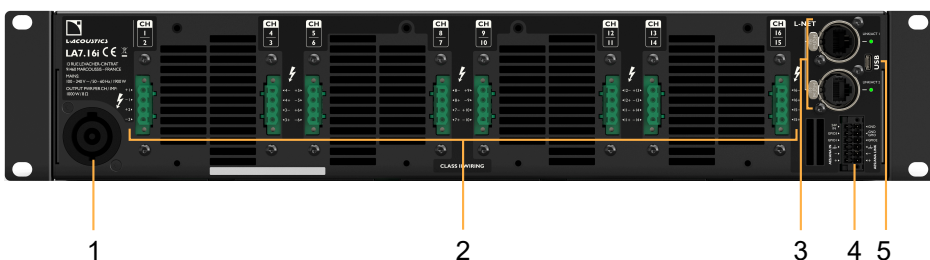

1. 1 x 32 A powerCON® connector
2. 8 output female 4-point terminal blocks
3. 2 x 1 Gb/s Ethernet etherCON® I/O connectors (top connector for primary network, bottom connector for secondary network)
4. 1 x 12-point terminal block that contains:
 - 1 x 24 V DC male to connect a backup power supply for the DSP
 - 1 ground pin
 - 3 General Purpose I/O (GPIO)
 - 1 ground GPIO pin
 - 1 AES/EBU input connector including:
 - 1 + signal pin
 - 1 - signal pin
 - 1 shield pin
 - 1 AES/EBU link connector including:
 - 1 + signal pin
 - 1 - signal pin
 - 1 shield pin
5. 1 USB Micro-B port for configuring IP settings. Refer to the **LA Network Manager** Help.

Signal processing and amplification

Signal inputs

LA7.16i features two 1 Gb/s Ethernet ports capable of receiving up to 128 channels from 16 AVB streams at 48 kHz or 96 kHz.

In addition, an AUX (auxiliary) input in either AES/EBU or Analog mode is available through the 12-point terminal block.

The AUX input source can be used as main input source, secondary input source, or fallback input source.

Refer to the **LA Network Manager** Help for more information.

AVB

LA7.16i can operate in normal network mode or in redundant network mode.

In both modes, 16 AVB streams of up to eight channels may be connected to LA7.16i.

Each Ethernet port uses a high speed data transfer protocol up to 1 Gb/s and supports the IEC 61883-6 AM824 and AAF PCM32 stream formats with stream frequencies of 48 kHz or 96 kHz.

The amplified controller synchronizes its media clock according to the selection done by the user:

- internal clock generator
- one of the 16 AVB input streams
- the Media Clock stream in CRF format connected to its Media Clock input stream

The default selection is AVB input stream 1. When a CRF master media clock is available in the network, it is recommended to use it as clock source. LA7.16i features a CRF output stream that may be used as media clock master for the network.

In normal network mode, the Ethernet ports operate as part of an AVB bridge and may therefore be used to create an AVB network.

In redundant network mode, each port is dedicated to separate networks: first port for primary network, second port for secondary network.

Input channels can be freely assigned to the 16 amplification channels through flexible summing matrix.

AES/EBU

LA7.16i can be fed with one AES/EBU digital audio signal (containing two channels) using the 12-point terminal block (AES/ANA IN).

The audio signals can come from a digital mixing desk or from any audio device compliant with the AES/EBU (AES3) digital audio standards.

The input signals can be transmitted to daisy-chained amplified controllers using the 12-point terminal block (AES/ANA LINK).

The AES/EBU input port is equipped with an SRC (Sample Rate Converter) that has been selected to support a wide range of input formats (16 - 24 bits / 44.1 - 192 kHz). The SRC converts the formats to the 24 bits / 96 kHz internal format used by the amplified controller. The SRC is a high-quality hardware component (140 dB dynamic range, THD+N < -120 dBFS, strong input jitter attenuation) and provides constant propagation delay regardless of the input sampling frequency.

There is no AES/EBU external synchronization mode. The amplified controller's clock always runs at 96 kHz, referenced to the user-selected media clock: internal clock, AVB audio input stream, or CRF input stream. This ensures low jitter and high audio quality in live conditions (large cable lengths, large number of amplified controllers) while preventing phase shift, as required for line source systems.

Digital domain benefits

Keeping the signal in the digital domain provides the following benefits (with any digital mixing desk or any audio device) compared to the analog signal distribution:

- Better audio quality by removing one D/A - A/D cycle.
- Optimized level chain by removing the risk of level misalignment between console and amplified controllers.
- Digital signal refreshed at each amplified controller in a daisy-chain.
- Improved maximum cable length. LA7.16i has been tested with up to 300 m / 984 ft of two models of AES/EBU rated cables (single cuts, digital source signal running at $F_s = 48$ kHz):
 - 1696A from BELDEN INC.
 - OT234H from KLOTZ communications GmbH.

Analog

LA7.16i can be fed with one balanced analog audio signal using the 12-point terminal block (AES/ANA IN, AES/ANA LINK).

The input signal can be transmitted to daisy-chained amplified controllers using the 12-point terminal block (AES/ANA LINK).

To be processed by the DSP, the analog signal must be converted into a digital signal. For this purpose, the LA7.16i amplified controller is fitted with one 32-bit A/D converter with a sampling rate of 96 kHz, allowing an encoding dynamic range of 117 dB (A-weighted, 20 kHz bandwidth).

DSP architecture

The proprietary algorithms allow optimum performance and protection of each individual transducer of the L-Acoustics systems for an even more natural, transparent, and realistic sound experience.

- The DSP engine is a 32-bit floating point DSP at 96 kHz sampling rate providing an enhanced dynamic range since it does not generate calculation clips like a fixed point DSP.
- A dedicated engineering approach combining IIR and FIR filters generates perfectly linearized phase curves and significantly improved impulse responses.
- The 16 × 16 matrix architecture offers flexibility for various system configurations.
- A delay of up to 1000 ms can be set for each output channel.
- The L-DRIVE transducer protection system offers advanced protection by simultaneously monitoring the excursion and the temperature of the transducer.
- With a complete factory preset library and the possibility to create additional user presets, the flash memory provides a quick access to all the usual L-Acoustics speaker system configurations (refer to the **Preset Guide**).

audio path parameters

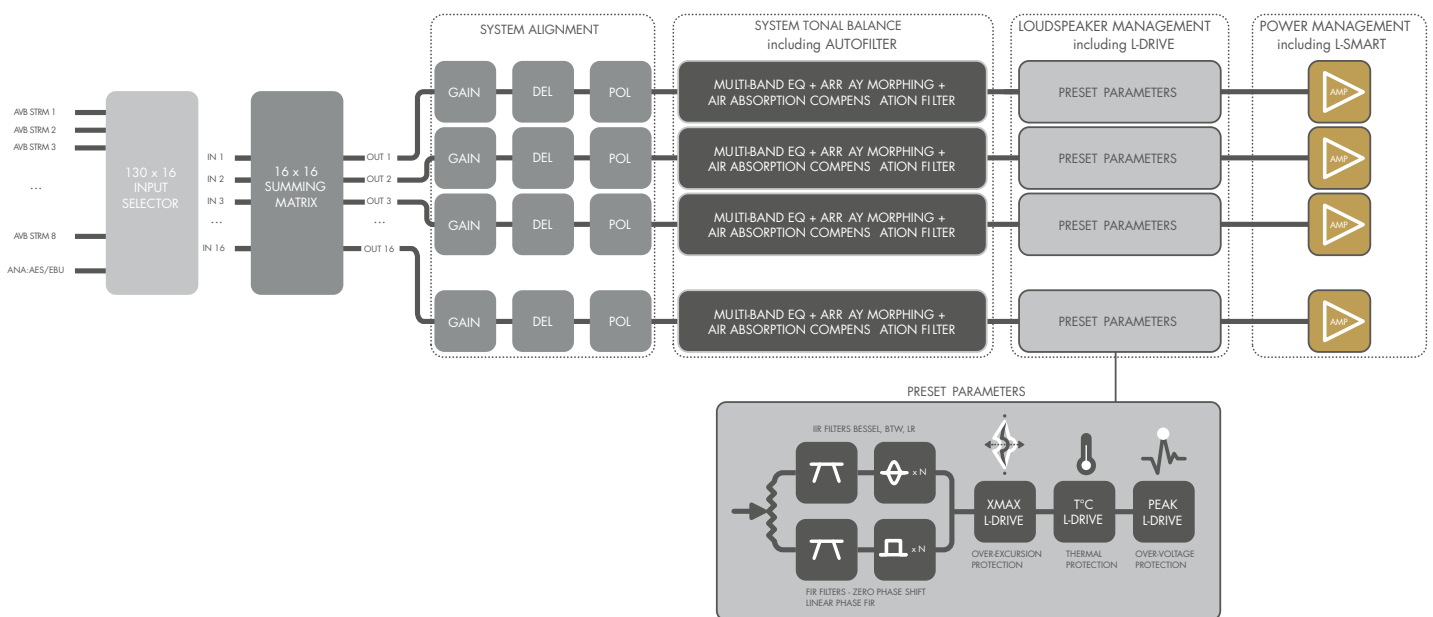

Power supply and amplifier section

The Class D amplification circuits ensure that the LA7.16i is energy-efficient for minimal heat dissipation. LA7.16i delivers (12 dB Crest Factor 2 ms, 1kHz, all channels driven, sine burst):

- 16 × 1100 W at 4 Ω
- 16 × 1300 W at 8 Ω
- 16 × 700 W at 16 Ω

LA7.16i is a green amplified controller that relies on a universal Switched Mode Power Supply (SMPS) suitable for mains 100 V AC - 240 V AC ($\pm 10\%$, 50 Hz - 60 Hz). The SMPS features PFC (Power Factor Correction) which maximizes the amplifier efficiency and takes advantage of nearly 100% of the electrical power available with a very high tolerance to unstable mains. This represents a reduction of the electrical power requirements (cable gauge, power conditioning, etc.) for substantial savings.

Speaker outputs

LA7.16i features eight female 4-point terminal blocks for loudspeaker outputs.



Risk of speaker and amplified controller damage

LA7.16i does not support any bridge mode.

Speaker protection

The L-DRIVE transducer protection system provides a dual analysis of both signal intensity and voltage in real-time and RMS. Under extreme conditions, when component membranes reach the over-excursion zone or if the coil temperature reaches a critical point, L-DRIVE is activated and acts as a power regulator.

As a result, the amount of power delivered at any channel is adjusted to the dynamic and thermal capacity of each individual transducer.

Monitoring and control

User interface

The LED display provides real-time monitoring functionalities:

- power
- L-NET network
- status
- mute, level, limit, clip, and error for each output



Refer to section [Operation](#) (p.32) for detailed operating instructions.

L-NET remote control network

Remote control of processors and amplified controllers requires setting up a private local area Ethernet network to interconnect up to 253 units (and additional devices such as Ethernet switches / AVB bridges) with a single control computer. This Ethernet network, called L-NET, uses L-COM PROTOCOL, a proprietary communication protocol based on TCP/IPv4.

The integration of the L-NET Ethernet-based network, with its high speed data transfer protocol up to 1 Gb/s, allows up to 253 amplified controllers to be controlled and monitored in real-time from LA Network Manager.

Multiple network topologies such as daisy-chain, star, and hybrid are configurable. The computer running LA Network Manager and the amplified controllers are connected to each other using industry standard CAT5e U/FTP cables (or higher category) fitted with RJ45 connectors.

The LA7.16i connects to the network via the two Ethernet etherCON[®] I/O sockets located on its rear panel.



Refer to the **LA Network Manager** Help for detailed operating instructions.

Third party management solutions

L-Acoustics is a certified member of the Crestron[®] partner program, and provides software modules allowing control integration into their automation systems.

L-Acoustics provides a plug-in for control and monitoring of LA2Xi, LA4X, LA7.16i, and LA12X on the QSC Q-SYS platform.

Inspection and preventive maintenance

How to do preventive maintenance

Inspect the product periodically as indicated, and after any corrective maintenance operation.

Structure and cleanness

Before and after each deployment (touring applications), or at least once a month (fixed installations):

- [CHK - External structure](#) (p.16)
- [CHK - Cleanness](#) (p.17)

Functionalities

At least once a year:

- [CHK - Normal start-up sequence](#) (p.17)
- [CHK - Network functionalities and firmware](#) (p.17)

CHK - External structure

The  indicates a visual inspection.

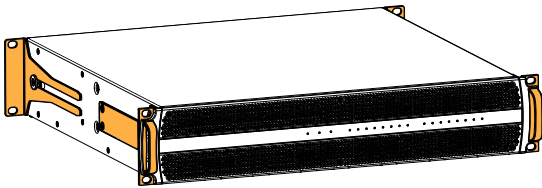

side brackets, front handles, and rear brackets are present and not damaged

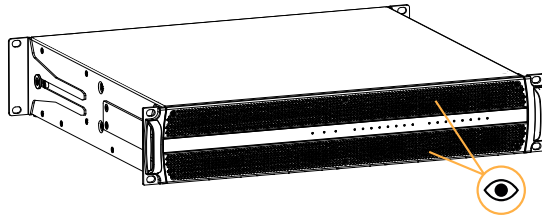

front grills are clean and not damaged
see also [CHK - Cleanness](#) (p.17)

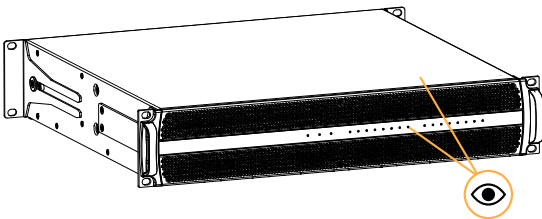

chassis and LEDs are not damaged

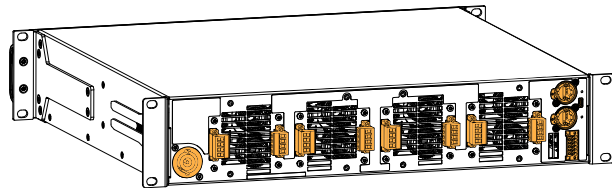

connectors and paired connectors are not damaged

CHK - Cleanness

Equipment

- air blower

Procedure

Clean the amplified controller through the front grill with an air blower.

CHK - Normal start-up sequence

Procedure

1. Plug the amplified controller to mains.
2. Check that all the LEDs light up in orange during the start-up sequence.
3. Check that fan noise can be heard for a few seconds during the start-up sequence.

CHK - Network functionalities and firmware

Equipment

- computer with LA Network Manager version beta 3.3.0 minimum
- appropriate network cable

Procedure

1. Connect the Ethernet port 1 of the amplified controller to an Ethernet port of a computer running LA Network Manager.
Use the appropriate network cable.
2. Run LA Network Manager.
3. Check that the amplified controllers are detected as online Units.
Refer to the **LA Network Manager Help**.
4. Check that all LA7.16i in the system run the same version of the firmware, and that it matches with the version of LA Network Manager in use.
Refer to the **LA NWM and Firmware Compatibility Issues** technical bulletin.
5. If convenient, update LA Network Manager and the firmware to the latest versions.
 If using a third-party control system such as Crestron or QSC Q-SYS, check that updating the firmware does not break compatibility.

Installation

Mounting

The LA7.16i is two rack units high (2U) and can be mounted in an EIA-standard 19" rack using the four points on the front panel. Use the fixing material provided by the rack manufacturer to mount the controller to the rack front rails.

LA7.16i dimensions

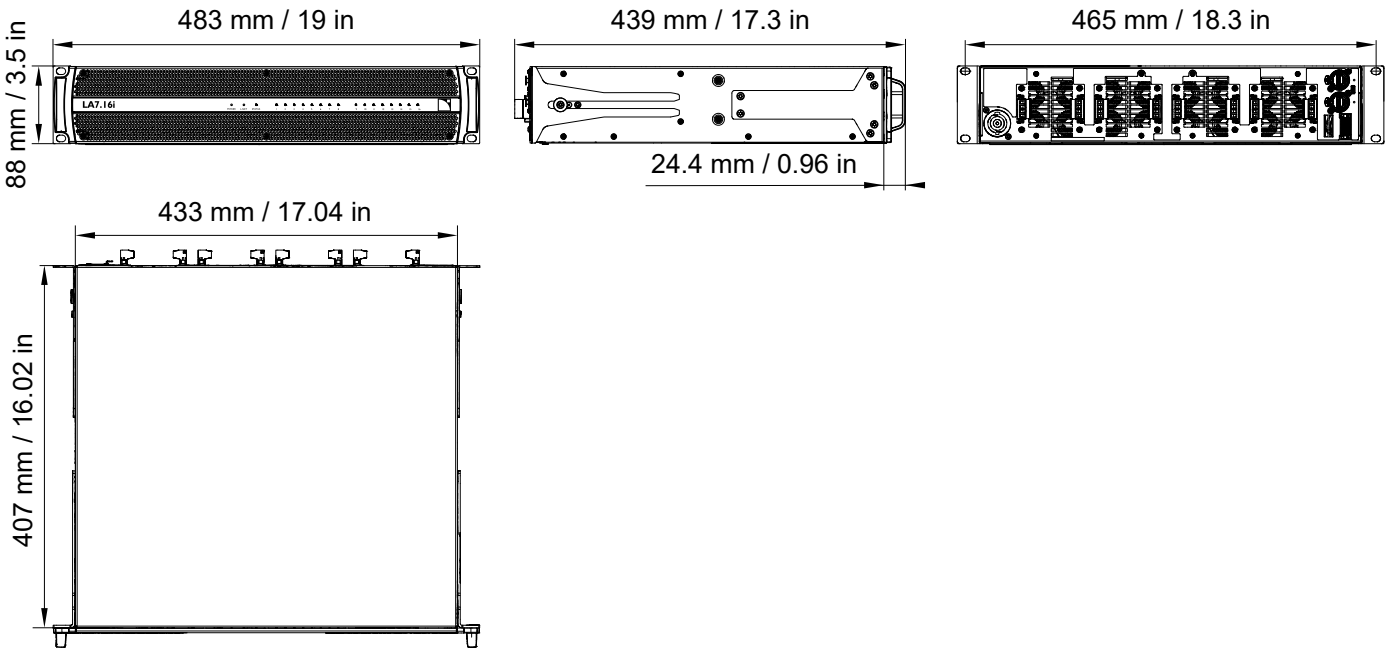

LA7.16i with rear rack support brackets

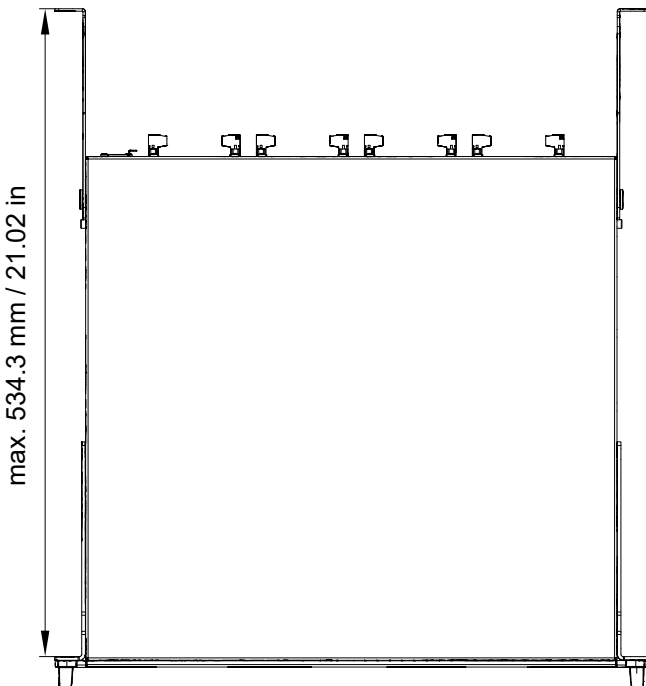

Risk of damaging the amplified controller

The amplified controller should be rear supported in addition to the front panel mounting.

Use the rear brackets provided with the amplified controller.

Any mechanical damage to the amplified controller used without rear support is not covered by warranty.

Ventilation

To maintain moderate operating temperatures, the LA7.16i is equipped with DSP-controlled fans and grills providing front to rear airflow.



Ventilation instructions

Install the controller in an open area so that the front and rear panels are located at a minimum distance of 30 cm / 12 in from any external object or structure.

Ensure the front grill is clean and dirt free.

Do not block the front and rear ventilation grills.

Ventilation when rack-mounted

Do not block the ventilation grills with front or back panels or doors. If not possible, use a forced-ventilation system.

When stacking more than one controller in a rack, mount them directly on top of each other or close any open space in the rack with blank panels.

General Purpose I/O (GPIO)

The amplified controller's rear side features a 12-point terminal block General Purpose I/O (GPIO).

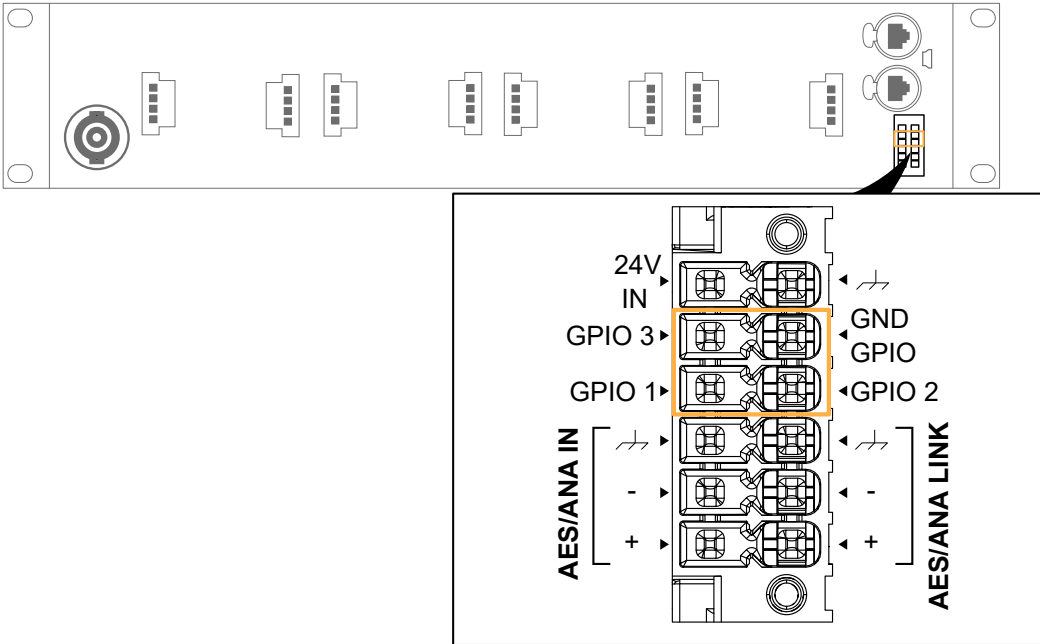

Pin	Description		Pin
GPIO 3	General Purpose I/O 3	GPIO ground	GND GPIO
GPIO 1	General Purpose I/O 1	General Purpose I/O 2	GPIO 2

GPIO can be configured using LA Network Manager. For more information, refer to the **GPIO on L-Acoustics products** technical bulletin.

Connecting to AC mains

Electrical specifications

AC mains specifications



Verify the electrical conformity and compatibility of the mains supply.

Only connect the product to an AC power outlet rated 100-240 V, 50-60 Hz, with the following current values:

100-120 V: 30 A

220-240 V: 16 A

WARNING: The product is of Class 1 construction and shall be connected to a mains socket outlet with a Protective Earth connection.

Three-phase circuit



When the product is used in a three-phase circuit, verify the electrical conformity and compatibility of the three-phase circuit.

Verify that the three phases work, and balance the loads between the three phases.

Verify that the neutral and earth work.

Never try to emulate a 230 V circuit connecting an apparatus to two live wires of a 120 V three-phase circuit.

Never try to emulate a 200 V circuit connecting an apparatus to two live wires of a 100 V three-phase circuit.

Circuit breaker



The power supply feeding LA7.16i must be equipped with circuit breakers meeting the following requirements:

The circuit breaker must operate on each phase separately (no mechanical link between phases).

Use these references, or equipment with equivalent characteristics:

100-120 V: 30 A, Schneider Electric Square D 30A QO (in North America), or Mitsubishi CP30-BA-M (in Japan).

220-240 V: 16 A, Type C.

Circuit breakers of different characteristics could trip in case of short-term, high current draw, because they do not match LA7.16i Fuse Protect algorithms.

Planning the power of the electrical generator



Electrical generator

You must power on the generator before powering on the product.

LA7.16i draws 16 A from 230 V.

A typical generator has a power factor of 0.8 and should operate at 70% load for good efficiency.

The kVA provision for one LA7.16i should therefore be:

$$(16 \text{ A} \times 230 \text{ V}) / (0.8 \times 70\%) = 6.5 \text{ kVA}$$

This calculation is an example using typical values. It can be adapted using the table in section [Power consumption](#) (p.22).

Power cord

The removable power cord is fitted at one end with a 32 A powerCON connector.

The other end and the wires color code depends on the cord type, as follows:

type	plug	live	neutral	ground
CE	CEE 7/7, 16 A / 250 V, grounded	brown	blue	green/yellow
CN	GB1002 GB2099, 16 A			
US	NEMA L5-30P, 30 A / 125 V, grounded	black	white	green
INT	bare ends (local power plug to be fitted)	black	white	green/yellow

- ⚡** Strictly apply the specific safety regulations of the country of use.
 Do not defeat the ground connection of the supplied power cord using an adaptor or any other method.
 Verify that the plug conforms to the specific voltage and current rating given in section [Electrical specifications](#) (p.21).

Plugging the amplified controller

How to plug the amplified controller to the AC mains.

Procedure

- First, connect the powerCON to the amplified controller mains panel.

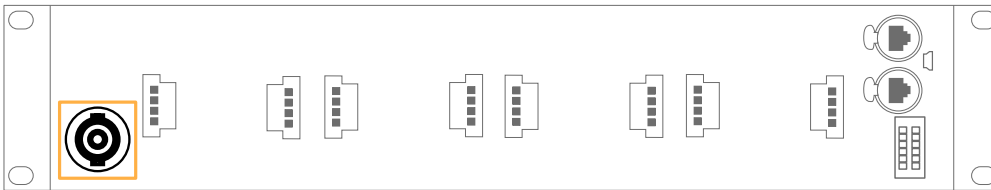

- Then, connect the power plug to the mains socket.
 Following this order improves the powerCON longevity.

Power consumption

The LA7.16i power requirements depend on the load impedance and the signal level.

Mains input power and current draw (all channels driven)

Maximum output power (CEA-2006 / 490A 20 ms, ≤ 1% THD, 1 kHz, all channels driven, sine burst)	16 × 580 W at 16 Ω	16 × 920 W at 8 Ω	16 × 1000 W at 4 Ω
1/3 output power (-5 dB)	16.9 A / 3800 W	18.6 A / 4200 W*	19.2 A / 4300 W*
1/8 output power (-9 dB)	6.7 A / 1500 W	11.2 A / 2500 W	13 A / 2900 W

! * 1/3 output power measurements given for 11 channels (8 Ω) and 10 channels (4 Ω) loaded using the same signal simultaneously.

For more channels using the same signal simultaneously, the amplified controller will reduce output power below 1/3 output power.

Current values given for mains rated at 230 V. Multiply by:

- 2.3 for 100 V
- 1.92 for 120 V
- 1.15 for 200 V

i Output power references

A third (1/3) of the maximum output power corresponds to the worst case scenario of a program source using highly compressed music or pink noise with amplified controller driven to clip level.

An eighth (1/8) of the maximum output power corresponds to a loud music program with a small dynamic range and 9 dB of headroom (IEC standard power rating).

Mains input power and current draw in Idle and Standby modes

	230 V	120 V	100 V
Idle	1.2 A / 215 W	1.9 A / 217 W	2.2 A / 218 W
Standby	0.7 A / 18 W	0.5 A / 17 W	0.5 A / 17 W

Heat power calculation

If a 8Ω load is connected to each output channel of the LA7.16i, each channel delivers up to 920 W.

With a standard use at one eighth (1/8) of full power (9 dB headroom), the power delivered per channel is:

$$920 \text{ W} / 8 = 115 \text{ W}$$

Therefore, a total power of:

$$16 \times 115 \text{ W} = 1840 \text{ W}$$

According to the table in section [Power consumption](#) (p.22), the LA7.16i power consumption is 2500 W. The heat power produced is then (difference between power consumption and output power):

$$2500 \text{ W} - 1840 \text{ W} = 660 \text{ W}$$

24 V DC Input

The amplified controller's rear side features a 12-point terminal block for external powering of the DSP in case of mains failure.

In case of power failure, 24 V DC input (if used) allows for a faster recovery of the amplified controller and continued reporting and monitoring of the network and DSP.

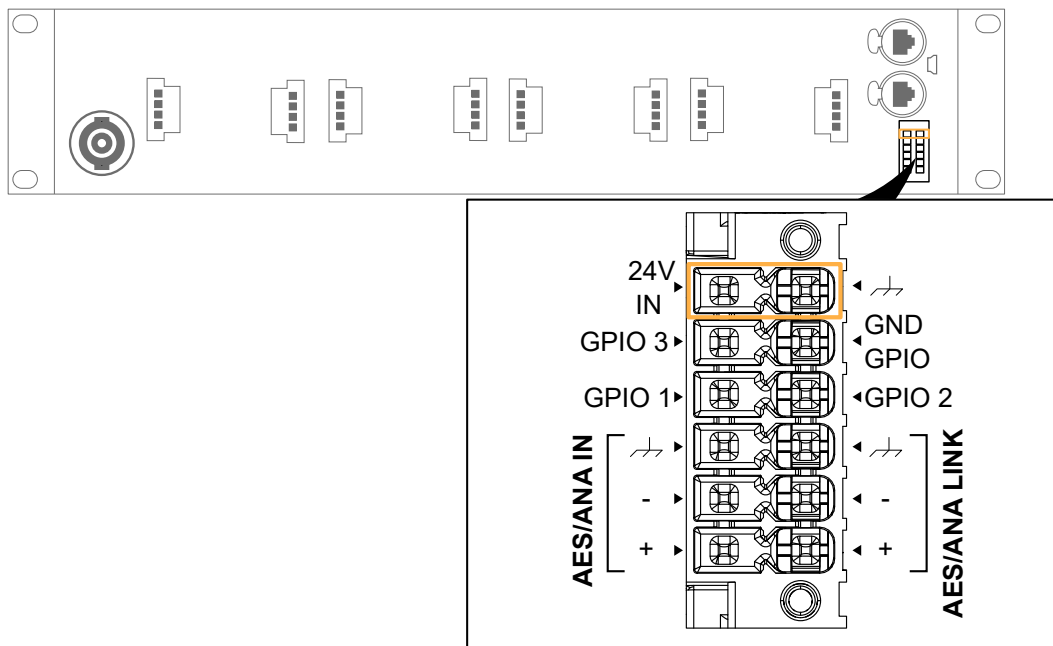

The external power supply should be rated 24 V DC ($\pm 15\%$) 17 W maximum.



LS10 24 V DC output is not powerful enough to supply LA7.16i DSP.

Audio and network cabling

Connection panels

The amplified controller's rear side features connectors for audio and network cabling:

1. For connection to the loudspeakers.
2. For connection of the analog or digital (AES/EBU) audio sources, and for linking the signals to another amplified controller.
3. For connection to an AVB network, and to be remotely controlled by LA Network Manager.

LA7.16i audio and network connection panels

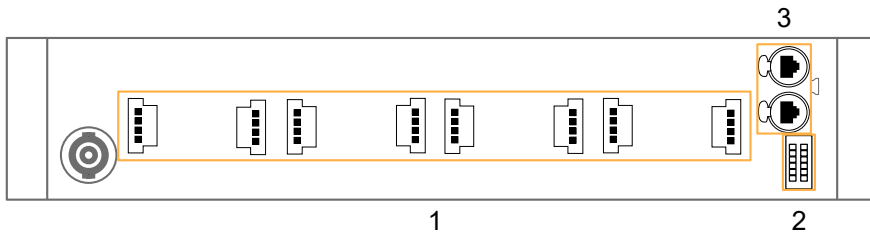

Speaker connectors

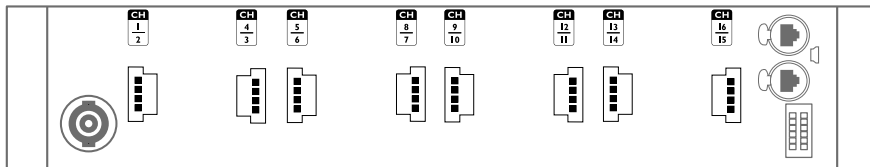

Use the eight female 4-point terminal blocks for loudspeaker connection. The connectors are wired from top to bottom as follows:

CH 1 - 2	CH 4 - 3
Out 1+	Out 4-
Out 1-	Out 4+
Out 2+	Out 3-
Out 2-	Out 3+
CH 5 - 6	CH 8 - 7
Out 5+	Out 8-
Out 5-	Out 8+
Out 6+	Out 7-
Out 6-	Out 7+
CH 9 - 10	CH 12 - 11
Out 9+	Out 12-
Out 9-	Out 12+
Out 10+	Out 11-
Out 10-	Out 11+
CH 13 - 14	CH 16 - 15
Out 13+	Out 16-
Out 13-	Out 16+
Out 14+	Out 15-
Out 14-	Out 15+

Output audio paths

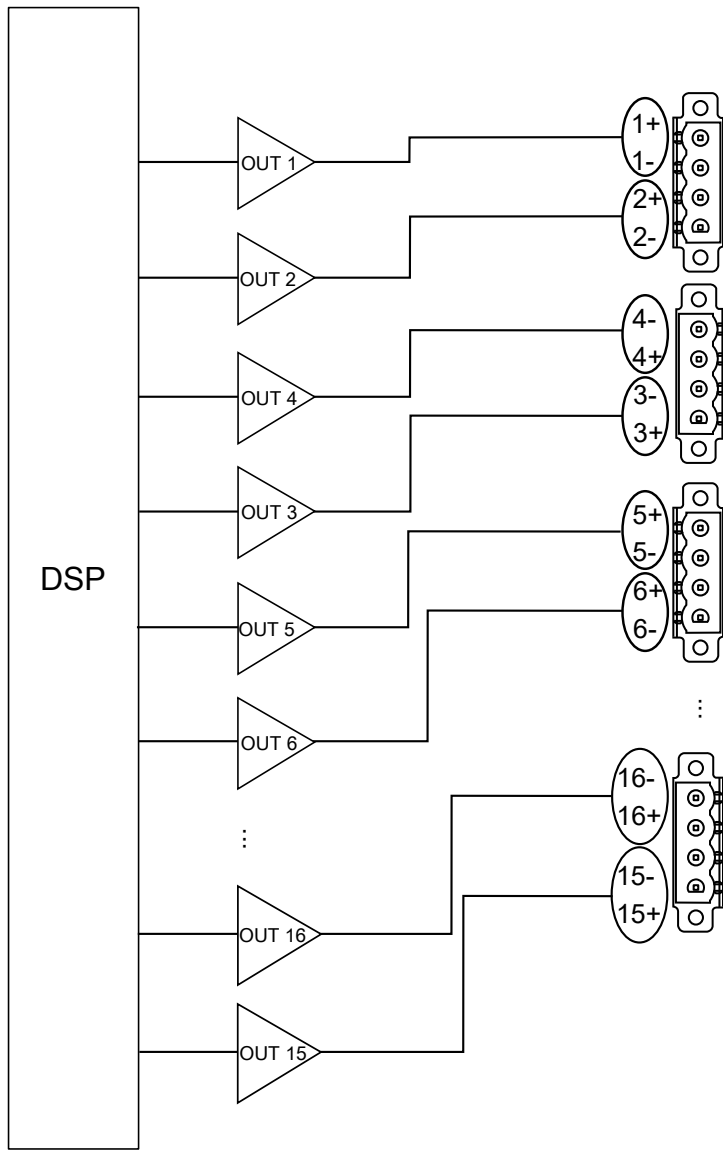

Analog/Digital output connectors

Use the male 12-point terminal block for digital (AES/EBU) and analog signal cabling.

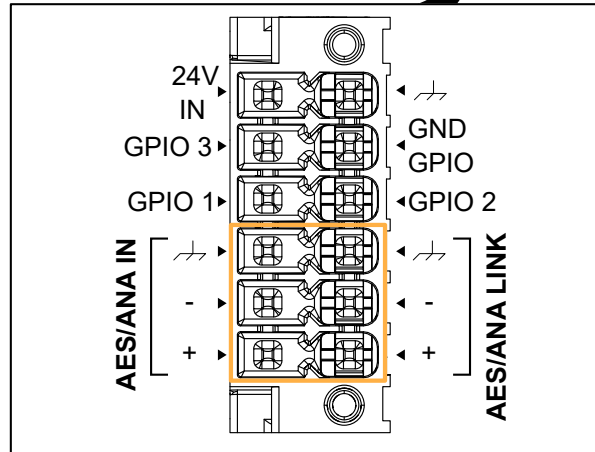
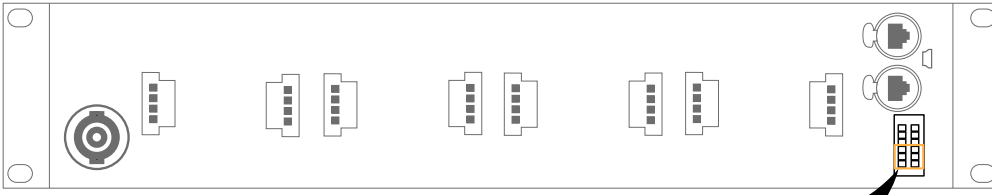

Analog inputs

AES/ANA IN can receive one analog signal (when setting the analog input mode). The headroom of the input circuits is high enough to accept the maximum output level from almost any line-level signal source (up to 22 dBu).

The input signals can be transmitted to daisy-chained amplified controllers using AES/ANA LINK.

AES/EBU inputs

Supported digital input format

Standards	AES/EBU (AES3)
Sampling frequency (Fs)	44.1, 48, 88.2, 96, 176.4, or 192 kHz
Word length	16, 18, 20, or 24 bits
Synchronization	signal resampled to internal clock at 96 kHz

AES/ANA IN can receive up to two (one stereo pair) digital signals (when setting the AES/EBU input mode).

The AES/ANA LINK connector is electronically buffered to allow daisy-chaining any number of amplified controllers. It also features a failsafe relay to ensure wiring continuity in case of amplified controller shutdown.

Ethernet connectors

Use the two etherCON connectors for the remote control of LA7.16i over the L-NET network using LA Network Manager. The etherCON connectors are AVB-capable.

In normal network mode, the two etherCON connectors are part of an internal AVB switch, and allow for daisy-chaining of additional devices.

In redundancy mode, the two etherCON connectors are independent: the LINK/ACT 1 connector is used for the primary network, and the LINK/ACT 2 connector is used for the secondary network.

Analog audio

i Balanced cables

Symmetrical (balanced) shielded cables are highly recommended as balanced signals are less sensitive to AC hum and radio interference.

Unbalanced lines may add noise especially over long cable runs.

In a daisy-chain layout, the AES/ANA LINK feeds the input signal to the next amplified controller in the signal chain.

daisy-chaining analog audio

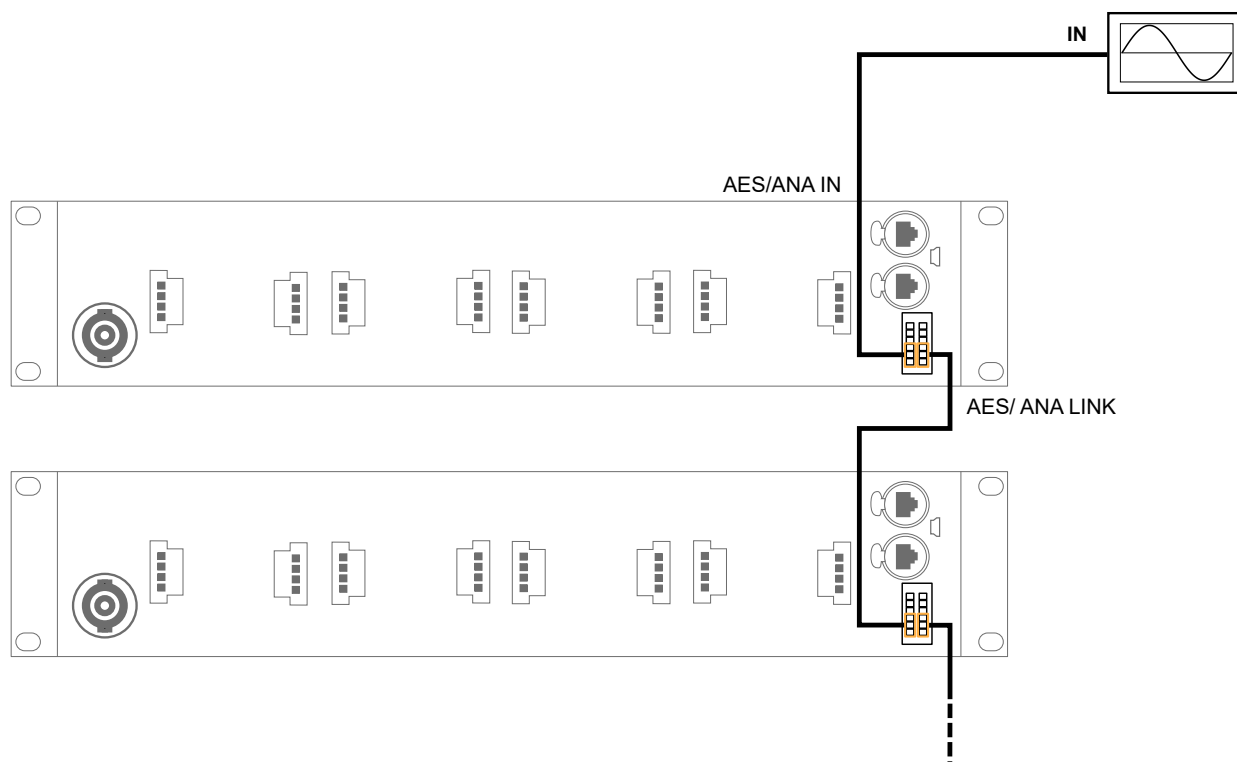

Digital audio

In a daisy-chain layout, the AES/ANA LINK feeds the input signal to the next amplified controller in the signal chain.

daisy-chaining digital audio

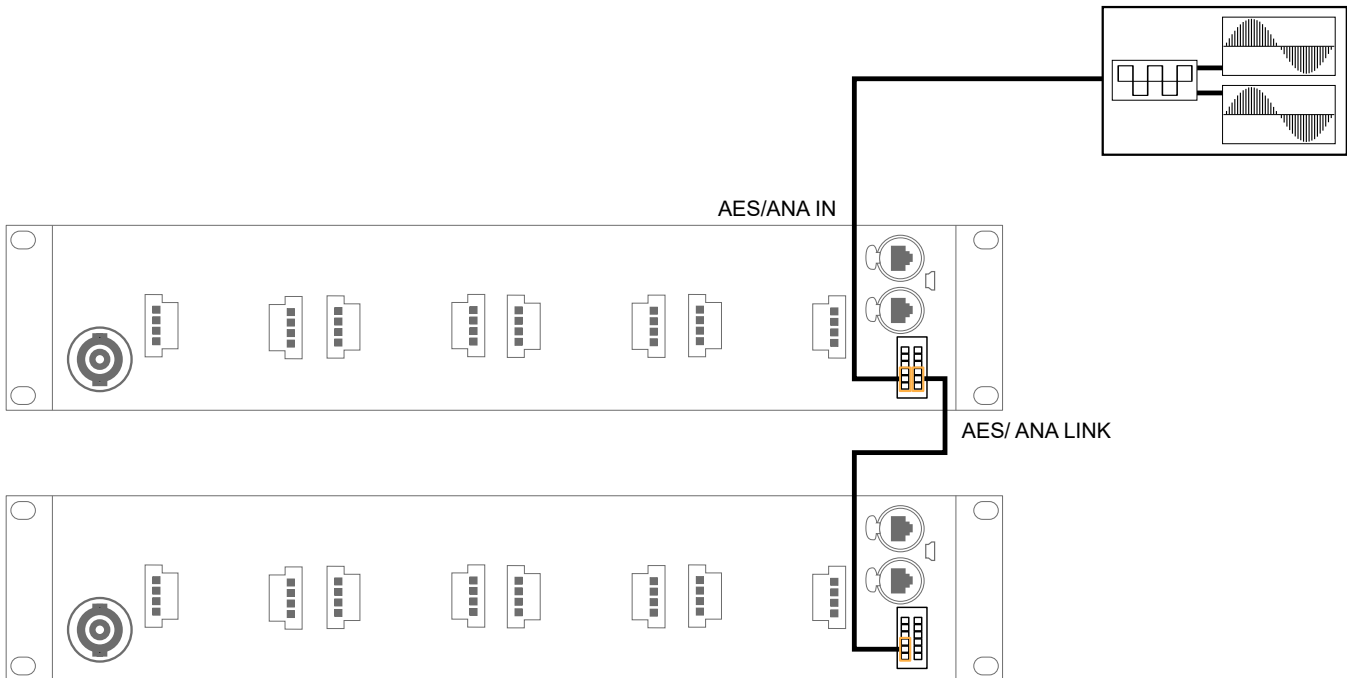

Cables for AES/EBU digital audio

AES3 specifies that the nominal characteristic impedance of cables used for AES/EBU digital audio transmission shall be $110 \Omega \pm 20\%$, and closer tolerances allow for increased transmission reliability over long lengths or higher sampling rates.

Therefore, it is highly recommended to use high-quality AES/EBU rated cables only, although certain cables designed for balanced analog audio prove to be acceptable at 48 kHz sampling rate over very short distances.

It is recommended to use single lengths of cable between AES/EBU outputs and inputs. Using several shorter cables joined together reduces performance. If it is not possible to use single lengths, it is required to use the same model of cable between two AES/EBU interfaces.

In case an amplified controller shuts down, the failsafe relay makes a passive connection between the AES/EBU IN port and the LINK port to maintain continuity. However the signals are no longer refreshed for the next amplified controller, so that the input cable and the link cable must be considered as a unique input cable with regard to the maximum supported length.

In case of transmission losses, try to reduce the sampling frequency of the digital audio source. Moreover, as a general rule, avoid using sources rated beyond 96 kHz, as the maximum possible cable length is reduced, while the additional information is discarded by the SRC to 96 kHz.

L-NET/AVB

 **Do not create loops in the network setup.**

 **Always place LA4 and LA8 after other types of amplified controllers in daisy-chain networks.**

LA4 and LA8 amplified controllers are equipped with former generation 100 Mb/s Ethernet ports that cannot communicate with Ethernet ports of different capabilities, creating detection issues in LA Network Manager.

Use the two etherCON connectors on the rear panel to connect LA7.16i both to L-NET and to an AVB network. Real-time audio traffic and control traffic are automatically managed by AVB on the same network.

LA7.16i supports AVB Milan in normal mode and in redundant mode. In Redundant mode, LA7.16i must be connected in star topology, port 1 being used for the primary network, port 2 being used for the secondary network. In normal mode, daisy-chain, star, or hybrid topologies are supported.

Refer to the **LA Network Manager** Help for network setup.

Remote control of processors and amplified controllers requires setting up a private local area Ethernet network to interconnect up to 253 units (and additional devices such as Ethernet switches / AVB bridges) with a single control computer. This Ethernet network, called L-NET, uses L-COM PROTOCOL, a proprietary communication protocol based on TCP/IPv4.

An IP address is a unique identifier for a network device on a given IP network. In IPv4 networking, it is made of 4 bytes (32 bits). An IP address is composed of a subnet address and a host address. The host address serves as a unique device identifier on the subnet. The subnet mask determines how many bits define the subnet address, and how many define the host address.

By convention, the first possible number of the host address is reserved to designate the subnet, and the last number is reserved to communicate with all devices of the subnet (IP broadcast address).

The factory default IP settings of all L-Acoustics devices are:

- IP address: 192.168.1.100
- Subnet address: 192.168.1.0/24
- IP broadcast address: 192.168.1.255
- Subnet mask: 255.255.255.0

With these settings, the first three bytes of the IP address (192.168.1) define the subnet address, and the last byte is the host address (100).

In general, it is recommended to:

- Use the default subnet address and subnet mask.
- Edit the device host address to provide a unique identifier to each unit: use consecutive IP addresses starting from 192.168.1.**1** up to 192.168.1.**253**.
- Set the control computer to 192.168.1.**254**.

However, it is possible to configure other IP settings when required by network administration. Subnet mask may be defined from 255.0.0.0 to 255.255.255.0, and the IP and gateway addresses must both belong to one of the following IP ranges (standards for Private Local Area Networks):

- 10.0.0.1 to 10.255.255.254
- 100.64.0.1 to 100.127.255.254
- 172.16.0.1 to 172.31.255.254
- 169.254.0.1 to 169.254.255.254 (not recommended)
- 192.168.0.1 to 192.168.255.254

 **LA Network Manager and its host computer must be using the same subnet and Subnet mask as the units.**

For subnet settings, refer to the **LA Network Manager** Help.

Speaker

! Risk of speaker and amplified controller damage

LA7.16i does not support any bridge mode.

! When a short-circuit is detected, output channels are automatically muted. After resolving the short-circuit issue, output channels must be manually unmuted.

Use the eight female 4-point terminal blocks to connect enclosures to the amplified controller.

i Using multicore loudspeaker cables

Never connect more than one amplified controller on a single multicore loudspeaker cable.

Connecting several amplified controllers may cause audible interferences on the loudspeaker enclosures when the amplified controllers are in idle mode, even when muted.

Procedure

1. Refer to [Connection panels](#) (p.24) to locate the pins.
2. Connect the enclosure(s):

! Strictly follow the loudspeaker wiring diagrams.

Risk of unwanted noise and errors.

Risk of acoustic cancellations and lack of audio source localization (discrepancy in loudspeaker polarities).

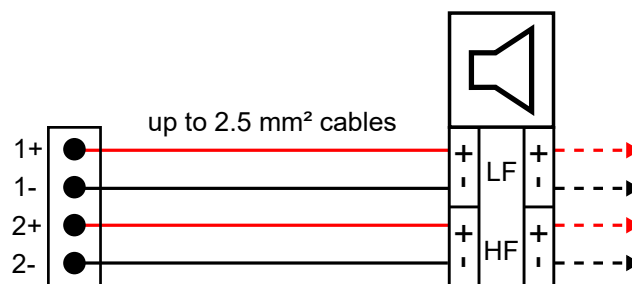

2-way active wiring scheme

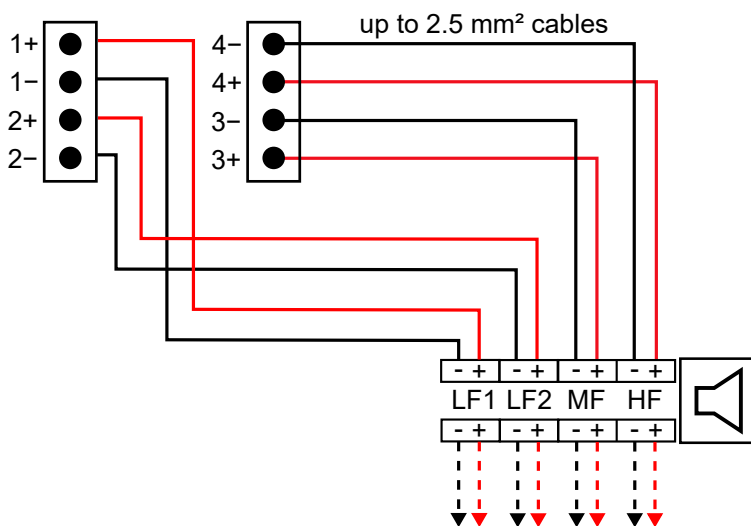

3-way active wiring scheme

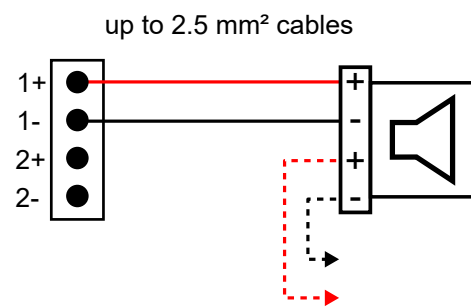

passive wiring scheme

3. Turn on LA7.16i.
4. Connect LA7.16i to LA Network Manager:
If using an existing session, solve any Unit Type conflicts in the Unit Matcher.

Connector references

usage	number	type	reference	max. cable gauge
GPIO	1	female 12-point terminal block (pitch 3.5 mm / 0.137")	Phoenix DFMC 1,5/6-ST-3,5 – 1790522	1.5 mm ²
24 V DC input				
AES/ANA input				
AES/ANA link				
loudspeaker output	8	female 4-point terminal block (pitch 5.08 mm / 0.200")	Phoenix IC 2,5/4-STF-5,08 – 1825336	2.5 mm ²

Use a 3.5 mm slotted screwdriver for terminal blocks to secure the loudspeaker output connectors to the amplified controller. Reference: Phoenix Contact SZS 0,6X3,5 – 1205053.

PHOENIX CONTACT is a trademark of PHOENIX CONTACT GmbH & Co. KG.

Operation

Powering on/off

LA7.16i turns on immediately when plugged, and turns off immediately when unplugged (no on/off switch), refer to [Plugging the amplified controller](#) (p.22).

If power is lost, the amplified controller shuts down, but all parameters are restored when the amplified controller is powered again.

The POWER LED is lit in orange when the amplified controller is in standby mode.

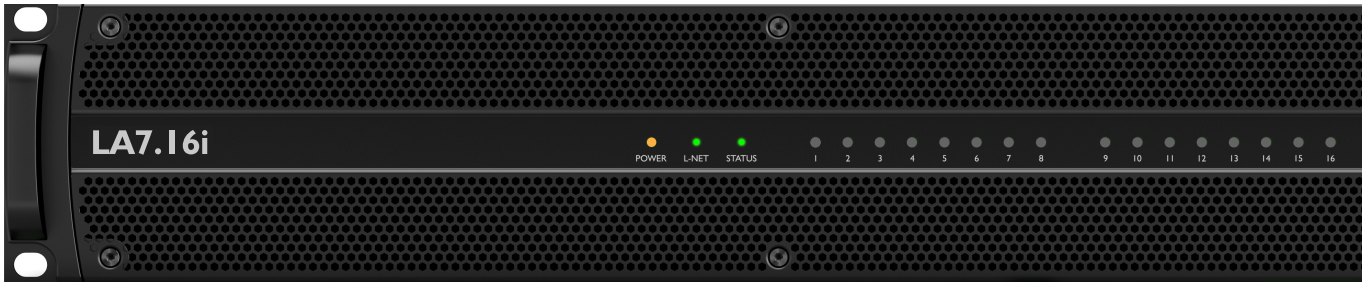

Use LA Network Manager to set the amplified controller to standby or back to operating mode. Refer to the **LA Network Manager** Help.

Interpreting the front panel LEDs

L-NET

The L-NET LED on the front panel displays the L-NET status.

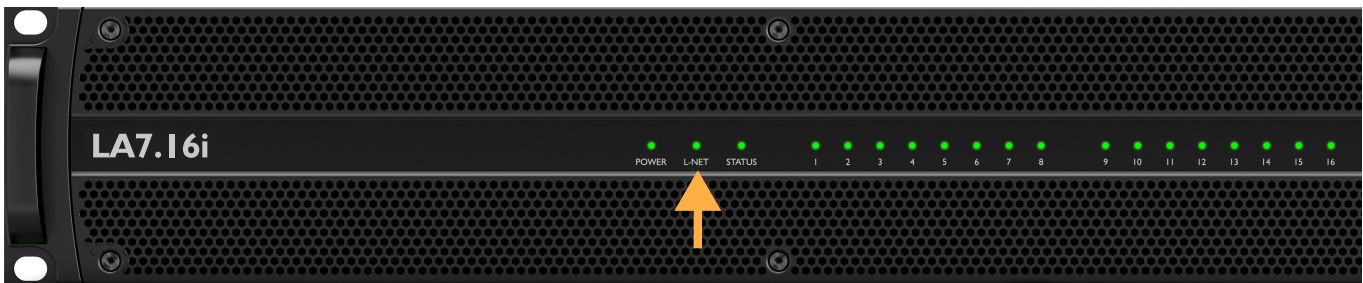

- green: when LA7.16i is remotely controlled by LA Network Manager (refer to the **LA Network Manager** Help).
- orange: when LA7.16i is remotely controlled by a third-party software.
- off: when no software remotely controls the amplified controller.

STATUS

The STATUS LED on the front panel displays the state of the amplified controller.

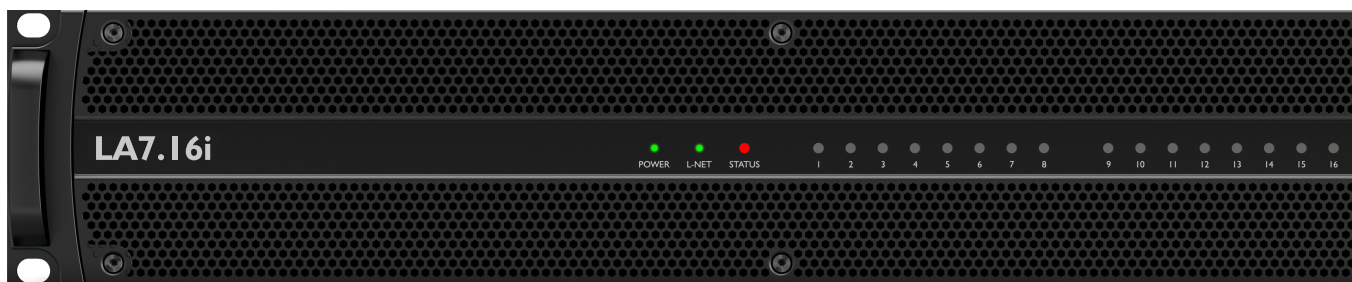

- green: when the LA7.16i operates normally
- orange: during firmware update
- red: when a fault is detected in the LA7.16i circuitry, indicating a protection system is active

Refer to the **LA Network Manager** Help for more information on errors.

Meters

The 16 LED meters display the state of the corresponding output channel.

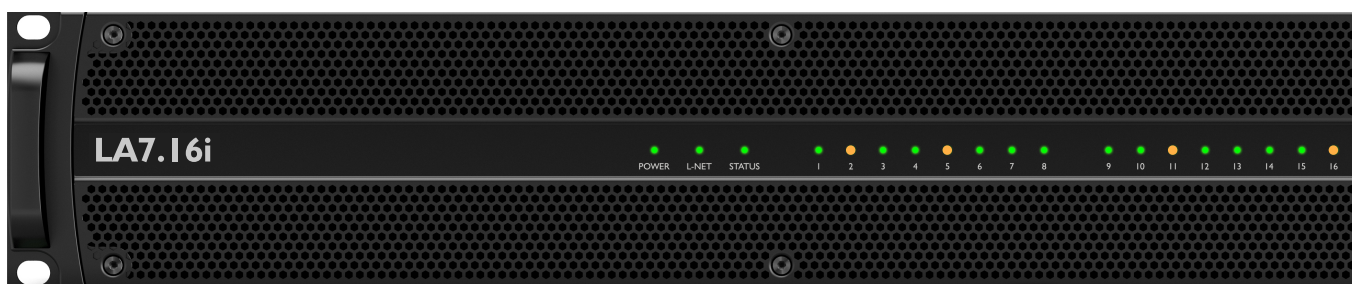

red	continuous	the output voltage reaches the maximum level (signal clip)
	fade in/out	the output channel is muted
	1 s blink	there is an error on the output channel
orange	continuous	the L-DRIVE limiter is activated with gain reduction of at least 3 dB
	blink	during identification from LA Network Manager
green	high	the output voltage reaches 20 dB below the maximum level
	low	the output voltage reaches 60 dB below the maximum level
	progress from 1 to 16	during firmware update
off		the output voltage is more than 60 dB below the maximum level

Other operations

The following operations can only be done from LA Network Manager.

Through the L-NET network:

- IP address
- Redundancy and spanning tree setting (RSTP)
- GPIO configuration (refer to the **GPIO** technical bulletin)
- Preset management (loading, storing, deleting)
- Input settings (input modes, fallback configuration)
- Standby mode and reboot
- Group parameters (names, gains, delays, contour EQs)
- Preset parameters (gain, delay, polarity, input selection)
- Monitoring and status (temperature, mains voltage, firmware and preset library versions, settings protection¹)
- Mute/Unmute

Through the USB port (in the **USB Terminal** utility):

 Disconnect the amplified controller from the L-NET network or switch LA Network Manager to offline mode when making changes from the **USB Terminal**.

- Subnet settings and redundancy
- Reset to factory default settings

Refer to the **LA Network Manager** Help for more information.

¹ Settings Protection does not prevent actions done from the **USB Terminal** utility. Take measures to restrict access to the USB port of the amplified controller.

Specifications

Specifications

All values given in this section are typical values.

General

Output power

12 dB Crest Factor 2 ms, 1 kHz, all channels driven, sine burst	16 × 700 W peak (at 16 Ω) 16 × 1300 W peak (at 8 Ω) 16 × 1100 W peak (at 4 Ω)
CEA-2006 / 490A 20 ms, ≤ 1% THD, 1 kHz, all channels driven, sine burst	16 × 580 W RMS (at 16 Ω) 16 × 920 W RMS (at 8 Ω) 16 × 1000 W RMS (at 4 Ω)
Maximum peak output voltage	152 V pk (loaded 8 Ω, single sine wave 1 kHz)
Amplification class	High-efficiency Class D
Digital Signal Processor (DSP)	Gen. 5 dual SHARCs 32-bit, floating point, 96 kHz sampling rate
Frequency response 20 Hz - 20 kHz	± 0.05 dB
Distortion THD+N	< 0.1% (20 Hz - 20 kHz, 8 Ω load, 60 W output power)
Output dynamic range (Digital input)	> 119 dB (20 Hz - 20 kHz, 8 Ω, A-weighted)
Amplification gain	32 dB
Noise level (Digital input)	< -79 dBV (20 Hz - 20 kHz, 8 Ω, A-weighted)
Channel separation	> 65 dB (at 1 kHz, 8 Ω, 60 W)
Damping factor	500 (20 Hz - 1 kHz, 8 Ω load)
Output delay	0 ms to 1000 ms

Mains input power and current draw (all channels driven)

Maximum output power (CEA-2006 / 490A 20 ms, ≤ 1% THD, 1 kHz, all channels driven, sine burst)	16 × 580 W at 16 Ω	16 × 920 W at 8 Ω	16 × 1000 W at 4 Ω
1/3 output power (-5 dB)	16.9 A / 3800 W	18.6 A / 4200 W*	19.2 A / 4300 W*
1/8 output power (-9 dB)	6.7 A / 1500 W	11.2 A / 2500 W	13 A / 2900 W

! * 1/3 output power measurements given for 11 channels (8 Ω) and 10 channels (4 Ω) loaded using the same signal simultaneously.

For more channels using the same signal simultaneously, the amplified controller will reduce output power below 1/3 output power.

Current values given for mains rated at 230 V. Multiply by:

- 2.3 for 100 V
- 1.92 for 120 V
- 1.15 for 200 V

Mains input power and current draw in Idle and Standby modes

	230 V	120 V	100 V
Idle	1.2 A / 215 W	1.9 A / 217 W	2.2 A / 218 W
Standby	0.7 A / 18 W	0.5 A / 17 W	0.5 A / 17 W

Power supply

Model	universal Switched Mode Power Supply (SMPS) with power factor correction (PFC)
Power factor	> 0.95 (at full load)
Mains rating	100 V AC - 240 V AC \pm 10%, 50 Hz - 60 Hz, 2800 W
Nominal current requirements	30 A for 100 V AC - 120 V AC, 16 A for 200 V AC - 240 V AC
Connector	32 A powerCON

Operating conditions

Temperature	-5 °C / 23 °F to 50 °C / 122 °F
Maximum altitude	2000 m

Protection

Mains and power supply	<ul style="list-style-type: none"> over and under voltage over temperature L-SMART overcurrent (fuse protection, and inrush current protection) power budget limiter
Power outputs	<ul style="list-style-type: none"> over current DC short circuit over temperature
Transducers protection	<ul style="list-style-type: none"> L-DRIVE excursion temperature over-voltage
Cooling system	fans with temperature-controlled speed
Fan noise (free field, 1 m)	<ul style="list-style-type: none"> at minimum speed: 33 dBA at maximum speed: 65 dBA

Interface and connections

Indicators	<ul style="list-style-type: none"> 1 power LED, 1 status LED, and 1 L-NET LED 16 signal LEDs
Output connectors	8 female 4-point terminal block
L-NET connectors	2 x 1 Gb/s Ethernet etherCON® I/O
Service port	1 USB Micro-B, 2.0 compliant - for configuring IP settings using the USB Terminal tool of LA Network Manager.

Input signal distribution

Interface and connections

Routing and summation matrix	16 × 16
Input	1 for analog or AES/EBU on the rear 12-point terminal block
Link	1 for Analog or AES/EBU on the rear 12-point terminal block

Digital input

Supported digital input format

Standards	AES/EBU (AES3)
Sampling frequency (Fs)	44.1, 48, 88.2, 96, 176.4, or 192 kHz
Word length	16, 18, 20, or 24 bits
Synchronization	signal resampled to internal clock at 96 kHz

Sample Rate Converter (SRC)

Sampling frequency	96 kHz (SRC referenced to the amplified controller internal clock)
Word length	24 bits
Dynamic range	140 dB
Distortion THD+N	< -120 dBFS (dB Full Scale)
Bandpass ripple	±0.05 dB 20 Hz - 40 kHz, 96 kHz

Input gain

Range	-12 dB to +12 dB
Steps	0.1 dB

Latency

Analog and AES/EBU

In standard operating mode	3.84 ms (independent from input Fs)
In low latency operating mode	1.18 ms (independent from input Fs)

AVB

Featured AVB entities	MILAN™-compliant, Avnu™-compliant AVB Bridge and Listener
Standards	Ethernet AVB: IEEE 802.1BA-2011 Transport: IEEE 1722-2016 (AVTP) Control: IEEE 1722.1-2013 (AVDECC)
Input audio stream	Number: 16 (in normal or redundancy mode) Class: A Maximum network latency: 2 ms Formats: AAF PCM32, up to 8 channels, at 48 kHz or 96 kHz IEC 61883-6 AM824, 8 channels, at 48 kHz or 96 kHz

Media clock	upon user selection: synchronized on clock of the connected AVB input stream (upsampling at 96 kHz in case of stream at 48 kHz) synchronized on clock of the connected CRF stream internal
Streams forwarded by AVB Bridge	up to 150

Automatic fallback option

Mode	AVB to AES or analog, with user-defined mapping
Switchover conditions	AVB: loss of lock
Constant delay	independent from input Fs
Constant level	upon manual user selection of gain, independent from input Fs
Revert to initial input	upon manual user selection

Remote control and monitoring

Network connection	dual-port Ethernet Gigabit interface
Network redundancy	RSTP
General Purpose I/O (GPIO)	3 GPIO, isolated Optocoupler Inputs, isolated Relays Contacts, available on the 12-point terminal block
External DSP backup voltage input	1 × 24 V DC ($\pm 15\%$) 17 W maximum
L-Acoustics remote control software	LA Network Manager version beta 3.3.0
Third-party management solutions	Crestron [®] , QSC Q-SYS

Crestron is a trademark or registered trademark of Crestron Electronics, Inc. in the United States, other countries or both. QSC[®] and Q-SYS[™] are trademarks or registered trademarks of QSC, LLC in the U.S. Patent and Trademark Office and other countries.

Physical data

Height	2U
Weight	14.5 kg / 32 lb
Finish	black
Protection rating	IP2X

LA7.16i dimensions

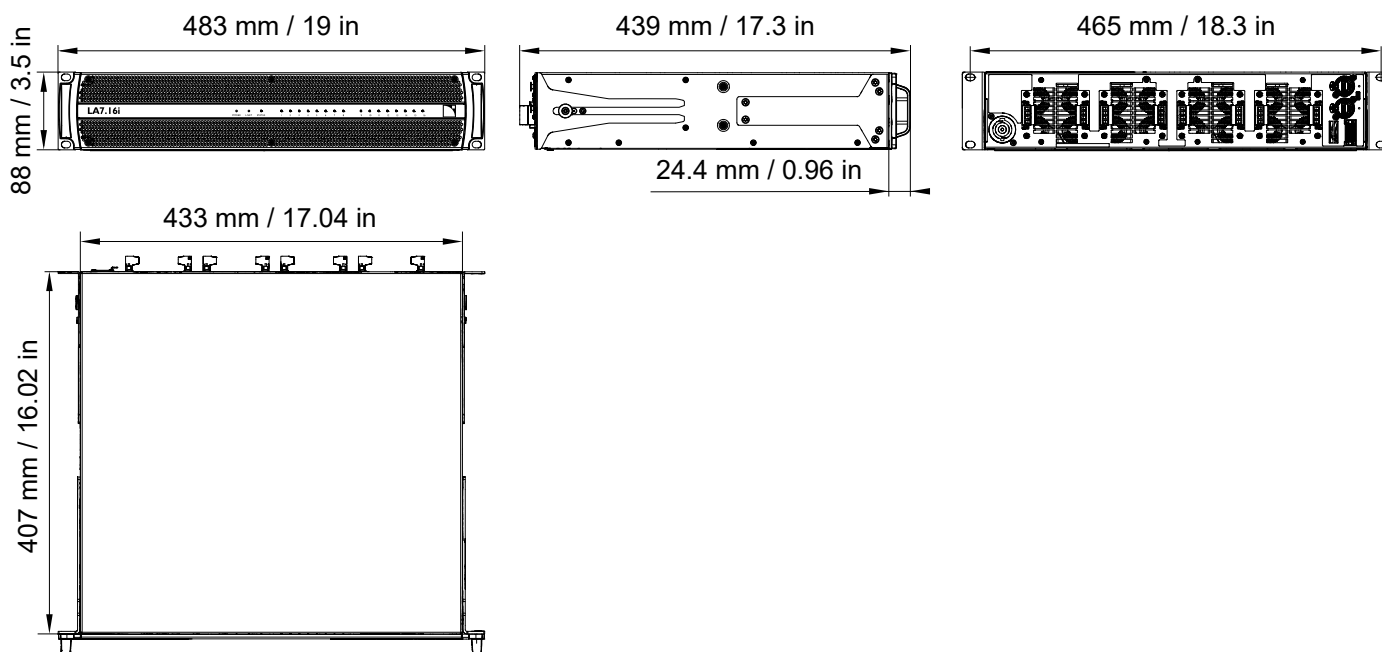

Glossary

CE	Europe
CHK	check procedure
CN	China
D/R	disassembly/reassembly procedure
KR	repair kit
SMPS	Switched Mode Power Supply (power supply inside of the amplified controller)
US	United States

Approvals

LA7.16i is compliant with the following:



Avnu Alliance and the Avnu design mark are registered trademarks and/or service marks of Avnu Alliance.



L-Acoustics

13 rue Levacher Cintrat - 91460 Marcoussis - France
+33 1 69 63 69 63 - info@l-acoustics.com
www.l-acoustics.com

 **L-ACOUSTICS**
GROUP