

1234A

Operating Manual
Genelec 1234A
Smart Active Monitor

GENELEC®



Genelec 1234A Operating Manual

Introduction

Congratulations and thank you for choosing Genelec!

Since 1978, Genelec has been guided by a single idea – to make perfect active monitors that deliver neutral and accurate sound in every kind of acoustical environment. In Genelec's quest for this ultimate goal, our unrivalled commitment to research and development has led us to continuously develop innovative driver technology, electronic circuitry, enclosure designs and more. Our design philosophy is based on sustainability and environmental values, where industrial design serves our products' acoustical performance.

Your Genelec product has been designed and manufactured with care in our factory, in Finland, using environmentally efficient solutions to give you reliable operation over many years.

Please take the time to read this manual. Happy monitoring!

General Description

The Genelec 1234A Smart Active Monitor is designed for neutral sound reproduction at high SPLs in large control rooms. The system comprises of a 160 litre enclosure and a RAM-XL 19 in 3U rack mount amplifier unit.

The monitor enclosure contains two 305 mm (12 in) bass drivers, a 130 mm (5 in) midrange, and a 25 mm (1 in) treble driver. The midrange and treble drivers are mounted in a Genelec Directivity Control Waveguide™ (DCW™) which can be rotated through $\pm 90^\circ$ for either horizontal or vertical mounting. The system low frequency response extends down to 29 Hz (-6 dB). The high frequency response extends up to 21 kHz (-6 dB).

Digital signal processing in the RAM-XL amplifier unit is done with high precision algorithms, and includes driver and amplifier overload protection. The room response compensations include highly flexible parametric filters, level alignment, and acoustic delay compensation. These allow accurate matching to all console output sections and room acoustics.

The power amplifiers of the RAM-XL

produce 2 x 750 W, 400 W and 250 W of short term power in the bass, midrange, and treble channels respectively.

Delivery Content

The Genelec 1234A Smart Active Monitor is shipped in a box containing an enclosure, an individually calibrated RAM-XL amplifier unit, a mains connecting cable, an RJ45 cable and one Allen key.

Before installing the system, check all items for damage and omissions. If damage is found, contact directly the distributor and insurance agent. If there are any missing components, contact your local dealer.

Cables

Each 1234A is delivered with the following cable kit:

- One mains cable
- Two 10 m (32 ft 9 in) 4-pole Speakon cables
- One 10 m (32 ft 9 in) RJ45 cable
- One 5 m (16 ft 4 in) RJ 45 cable

The 10 m cables are designed to go between the amplifier and the monitor enclosure. If you need to make custom length cables for this, please connect the Speakon cables pin to pin and see Table 1 for recommended wire gauges.

Amplifier Positioning

The RAM-XL amplifier is encased in a standard 19" 3U rack case. The cooling system circulates air into the amplifier from behind, so that it exits through the openings on the right side. Free flow of fresh air must be ensured and the space around the amplifier must be sufficiently ventilated to dissipate accumulating heat so that the temperature does not rise above 15-35 degrees Celsius (50-95°F). If the system overheats it will stop operating until a safe temperature is reached.

Make sure that the amplifier is positioned so that the monitor connecting cables will reach. A space 100 mm (4 in) deep should be left behind the rear panel of the amplifier unit to allow for the cable connectors and air circulation.

The RAM-XL amplifier is compatible with mains voltage supply of 100 - 120 VAC and 220 - 240 VAC 50/60 Hz.

Operating Environment

These monitors and their RAM-XL amplifiers are designed for indoor use only. The permissible ambient temperature is 15-35 degrees Celsius (50-95°F) and permissible relative humidity between 20% and 80%. Humidity condensation on the product is not allowed during use. For instance, if the product has been stored or transported in a cool environment and then taken into a warm room, it must be allowed to warm up to the ambient temperature before connecting to mains power.

Aligning the DCW

The 1234A monitor is designed to be flush mounted in either the vertical or horizontal configuration. The DCW should be rotated so that the treble and midrange drivers align vertically. This ensures that optimum stereo symmetry is obtained.

IMPORTANT-The DCW plate is heavy, care must therefore be taken when removing and replacing the DCW. To rotate the DCW plate, proceed as follows:

- Place the monitor in its intended listening orientation.
- Unscrew the eight M5 fixing screws on the edges of the plate using a 4 mm Allen key.
- Carefully pull the plate a small distance away from the enclosure. Rotate the DCW so that the midrange and treble drivers are aligned vertically (treble driver on top) and remount the DCW plate reversing the procedure above.

Flush Mounting of the Enclosure

Although the 1234A may be used successfully as a free standing monitor, flush mounting is strongly recommended for acoustical reasons. Flush mounting improves the bass response and efficiency and also enhances the midrange transient and frequency response.

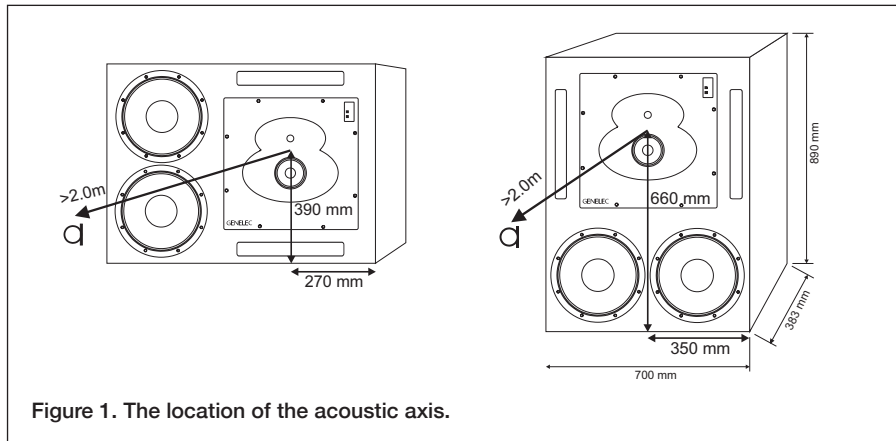

Figure 1. The location of the acoustic axis.

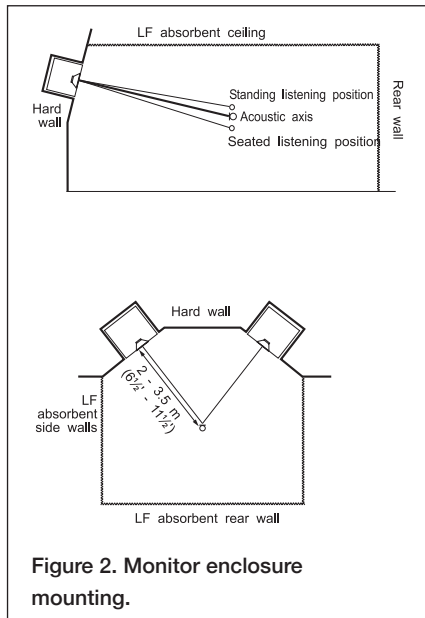

Figure 2. Monitor enclosure mounting.

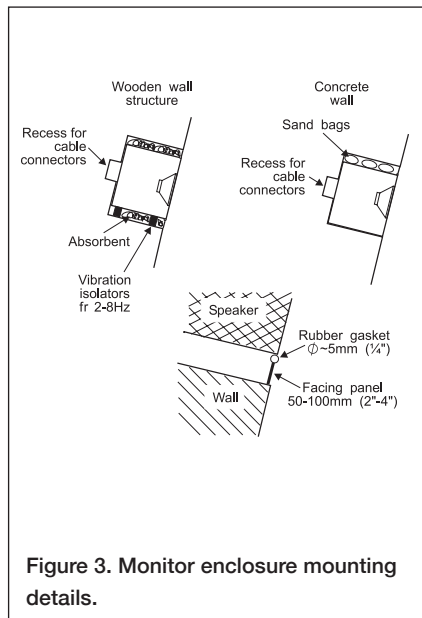

Figure 3. Monitor enclosure mounting details.

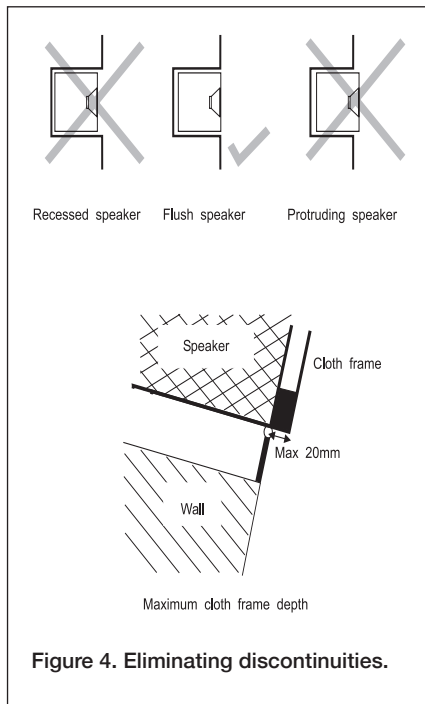

Figure 4. Eliminating discontinuities.

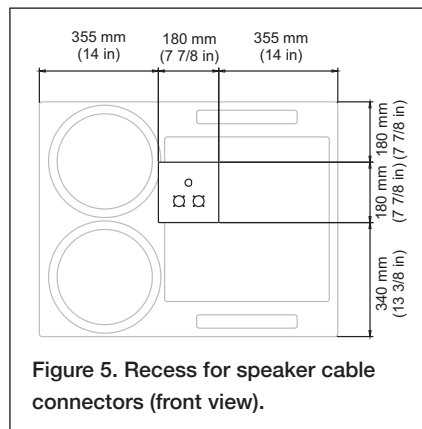

Figure 5. Recess for speaker cable connectors (front view).

Cable gauge	Max. length
2,0 mm ² (14 AWG)	30 m (100 ft)
3,3 mm ² (12 AWG)	40 m (130 ft)
5,3 mm ² (10 AWG)	60 m (200 ft)

Table 1. Recommended cable thicknesses for different lengths of speaker cable

The monitor enclosure has its acoustical axis midway between the midrange and treble drivers. This axis should be used as the listening and measuring axis of the system. (See Figure 1 and 2).

The typical listening distance varies between 2 and 3.5 m (6½ and 11½ ft) from the monitors. The monitor should be aimed so that the vertical acoustical axes of the two monitors meet midway between the standing and seated listening position (1.4 m – 4 ft 7 in from the floor). This allows the correct frequency response to be received by a standing or seated person. The monitors should not be mounted too high as this increases the required vertical tilt of the monitor and reduces the optimum listening area.

The ceiling, side walls and especially the rear wall should be acoustically absorbent at low frequencies. The monitor mounting wall should be acoustically hard and therefore reflective. The monitor mounting wall should be angled so that the monitors are correctly aimed. Great care should be taken over how the monitor is mounted into the solid and sturdy wall structure.

Note the following:

A space 50...100 mm (2...4 in) wide can be left around the monitor enclosure.

Cover the space around the enclosure with a facing panel, this should be fixed to the wall. Leave a gap of about 5...10 mm (¼...½ in) between the enclosure and the panel. Fill this gap with a soft rubber gasket to allow for possible enclosure movement. Ensure that the speaker cables can reach the rear of the enclosure. If a light (e.g. wooden), but heavily braced, wall is used, the monitor enclosure should be mounted on vibration isolators with a resonant frequency of around 2...8 Hz, to prevent vibrations from being transmitted to the wall and impairing the low frequency performance. The space around the enclosure should be filled with absorbent mineral wool or foam plastic. The walls must be well braced.

For a solid wall (e.g. concrete), the enclosure may be directly mounted to the wall without vibration isolators. The space around the enclosure should be filled with mineral wool or sand bags.

Discontinuities in the enclosure mounting wall will cause diffraction, which leads to

inferior frequency response and stereo image. Ensure that the enclosure is flush with the surface of the wall.

If a decorative cloth frame is used to cover the wall, make sure that the edges adjacent to the monitor are less than 20 mm (3/4 in) deep. The cloth must be very thin Tricot or acoustically transparent material, otherwise the high frequency response of the system will be adversely affected. Genelec approved cloth grilles are available.

Recess for Cable Connectors

The Speakon cable connectors extend 100 mm (4 in) from the rear panel of the monitor enclosure. Therefore, a recess at least 100 mm (4 in) deep must exist to allow for the cable behind the enclosure. The location of the recess is shown in Fig. 5. Note that the connectors are positioned off-centre. Therefore, if the enclosure is rotated for a left and right channel, the recess will be at different heights on the left and right side. This occurs when the enclosures are mounted in the horizontal configuration.

Connecting Speaker Cables

Insert the connectors into the appropriate sockets "WOOFER", "MIDRANGE/TWEETER" and "LED CONNECTOR" found on the rear panel of the amplifier unit and the rear of the monitor enclosure. Note that each RAM-XL amplifier is individually calibrated for use with the enclosure that it is delivered with and marked with the same serial number. Do not mix these amplifier/ enclosure pairs.

Insert the connectors into the sockets and turn the connectors clockwise. The connectors lock automatically. The electrical connections are only made when the connectors are fully inserted.

To remove the signal connectors pull the release lever on the connector and turn the connector counterclockwise simultaneously. The connector can now be removed from the socket.

Set-up and Use

The 1234A is set up using the GLM software. The setup is fast and consists of the following steps:

- Link all monitors and subwoofers in a

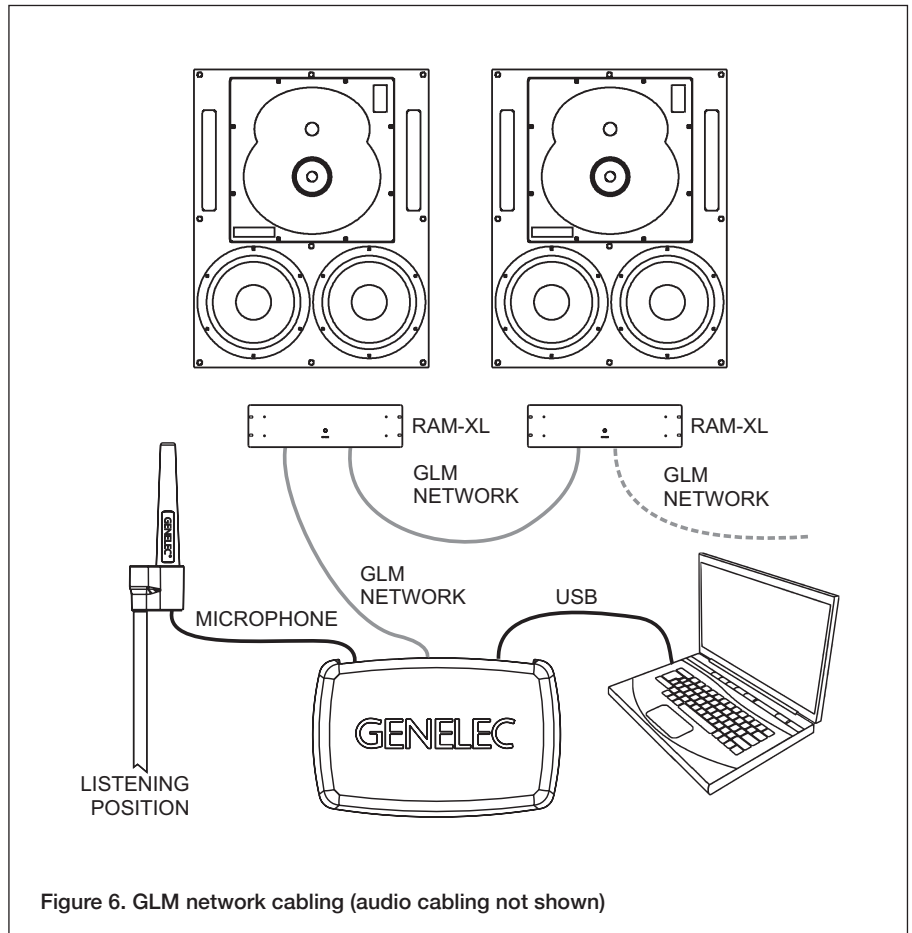

Figure 6. GLM network cabling (audio cabling not shown)

daisy-chain by running CAT5 (RJ45) network cables from the Network Adaptor to the "CONTROL NETWORK" connectors of the RAM-XL modules, and then on to the remaining monitors in the controls room. The actual order of the daisy-chain is not important, such that if the computer is in the control room and the RAM-XL modules are in a machine room, they can be networked last in the chain.

- Run the final network cable to control network input of the GLM Adapter device.
- Connect the GLM Adapter device to your computer USB connector. The cable is a part of the GLM User Kit.
- Place the Genelec measurement microphone at the listening location of the engineer, on a stand, with the microphone pointing upwards and the microphone top at the height of the engineers ear in normal working position. The microphone is a part of the GLM User Kit.
- Run the microphone cable to the

microphone input in the GLM Adapter device.

- Download GLM software at the Genelec web site (www.genelec.com). Install the GLM software.
- Follow the GLM software instructions to measure and set up your monitors.
- If you plan not to use a computer for controlling the monitors, use the GLM software to write the settings into the monitors ("Store the Settings").

Recommendations for AES/EBU Audio

For a digital input signal of -30 dB FS, the 1234A monitors will produce a 100 dB sound level (SPL) at 1 meter distance, in free space. The sensitivity of the monitor system is set using the GLM software.

It is advantageous to keep the maximum incoming digital audio signal level high, near to 0 dBFS. It may be useful to lower the internal GLM level control. This enables maintaining high digital resolution in the digital source.

Single-wire mode of AES/EBU is the

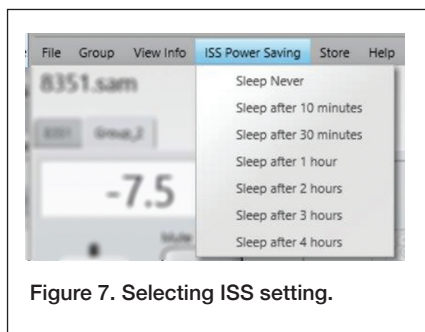

Figure 7. Selecting ISS setting.

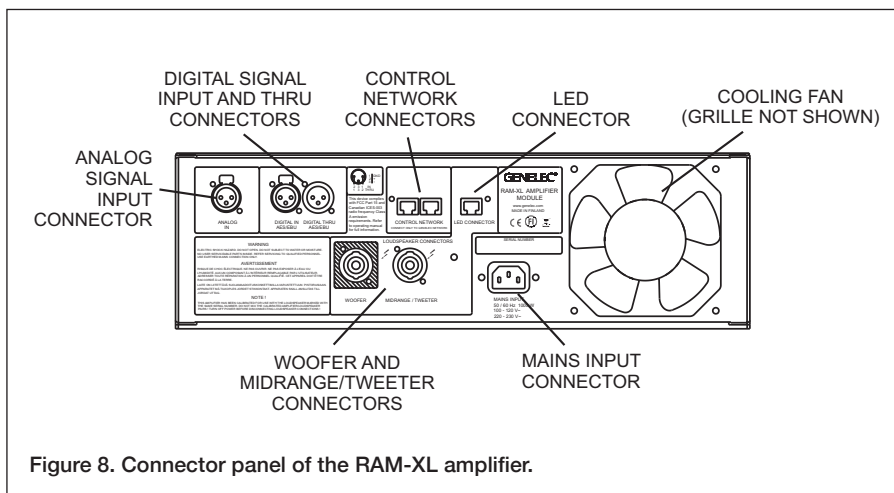

Figure 8. Connector panel of the RAM-XL amplifier.

default and the older dual-wire mode is automatically detected if used at the source.

The standard AES/EBU cable carries two channels of audio, called A and B. As a default, both A and B subchannels are reproduced by the monitor. GLM software is used to set up the monitor to specific channel assignments.

RAM-XL Amplifier Power Button

The power button in the middle of the RAM-XL amplifier front panel controls several functions.

A short press of the power button turns the RAM-XL on or off. Turning on, the power button light flashes rapidly, and lights on steadily when the turn-on has been completed. Testing modes are explained later in this manual.

Setting ISS™

The Intelligent Signal Sensing™ (ISS™) puts the monitor to a power-saving stand-by mode automatically. The factory setting for ISS is "OFF." The ISS can be activated using the GLM software (see Figure 5). When ISS is active, if no audio signal is sensed during the selected time, the monitor powers down. The monitor will power up again once a signal is detected. The ISS setting is applied to all ISS-enabled monitors in the currently selected Setup.

Connectors on the RAM-XL

“MAINS INPUT” Connector

Connect to the mains supply of 100 - 120 VAC or 220 - 240 VAC 50/60 Hz.

“DIGITAL IN AES/EBU” Connector

The monitor defaults to reproducing an analog input signal. The digital audio AES/EBU input is selected automatically when a valid digital audio signal is presented. Use GLM software to define the AES/EBU subframe to monitor.

“DIGITAL THRU AES/EBU” Connector

This output carries an unaltered copy of the digital audio signal and can be used for daisy-chaining the signal to up to three additional SAM monitors or subwoofers.

“ANALOG IN” Connector

The maximum input level of the analog input is +25.0 dBu. The analog input must not be overloaded, otherwise distortion will result. When the maximum input is exceeded, the enclosure front panel light turns red, indicating the overload.

The sensitivity of the monitor system is set using the GLM software. Coming from the factory, the analog input is set to the highest sensitivity, resulting in a sound output of 100 dB SPL for a -6 dBu analog input signal.

“CONTROL NETWORK” Connectors

The RJ45 sockets connect the monitor to the proprietary Genelec Loudspeaker Manager™ (GLM™) network. Do not connect to Ethernet LAN.

“Loudspeaker Connectors” Group

“LED” Connector

This RJ45 socket is a connection for the front panel warning LED.

“Woofers” Connector

A standard four-pole Speakon cable connects to the woofers.

“Midrange/Tweeter” Connector

A standard four-pole Speakon cable connects to the midrange and tweeter.

CAUTION! The “Woofers” and “Midrange/Tweeter” connectors on the RAM-XL amplifier can output hazardously high voltages. To ensure safety, the wiring connected to these connectors must be installed by a qualified and trained person.

Front Panel Light Functions

The green light on the DCW panel of a 1234A enclosure indicates normal operation. A yellow light indicates certain activities when the GLM control software is used. The light turns red in an overload condition. The overload light (red) is activated by several events:

- Exceeding the maximum input of the analog input
- Reaching close to the digital input maximum (high likelihood of digital clipping)
- Overload of drivers or amplifier, or clipping in the power amplifier
- An error detected in the AES/EBU audio data

If a red warning light appears on the monitor, turn the source level down. Ensure that there are no bit errors in the AES/EBU digital audio data transmission.

Button press	Function	Notes
Short press	Power on, power off	
Long press	Enter special mode, exit special mode	Press longer than 5 seconds
Special mode: one short press	Mode 1: AES/EBU channel A selected, room-related calibration in use	Power button light blinks once every few seconds
Short press advances	Mode 2: AES/EBU channel B selected, room-related calibration in use	Power button light blinks twice every few seconds
Short press advances	Mode 3: AES/EBU channel A selected, factory calibration in use	Power button light blinks three times every few seconds
Short press advances	Mode 4: AES/EBU channel B selected, factory calibration in use	Power button blinks four times every few seconds
Special selection: long press	Once a special mode 1-4 has been selected, a long press selects the special mode	Press longer than 5 seconds; the RAM-XL selects the special mode and starts playing. To exit the special mode turn off the amplifier.
Special mode: no press for 60 seconds	RAM-XL exits the special mode and turns off	Automatically happens if user does not press the power button

Table 2. Power button actions to activate testing modes

Testing Mode

Once on, when the power button is pressed for a long time, the RAM-XL enters a mode for system testing. This special mode is intended for system debugging and testing. When the RAM-XL is turned off, the special mode is reset. Upon restarting the RAM-XL the current standard settings stored by GLM software are restored.

Test mode selection blinks the power button light (see Table 2). A special mode is activated by a long press on the power button. In a special mode the power button light remains on but blinks off 1-4 times indicating the mode currently selected.

The testing modes are not intended for continued operation. Use GLM software to set up permanent settings for the 1234A.

Maintenance

Periodically check that the protective grille on the cooling fan on the back panel of the RAM-XL amplifier is clear of blockages. Clean gently with a vacuum cleaner if

necessary. Increased fan noise can be an indication of increased heat load due to a blockage. In an extreme case the amplifier may automatically shut off.

Safety Considerations

Although this product has been designed in accordance with international safety standards, to ensure safe operation and to maintain the monitor under safe operating conditions, the following warnings and precautions must be observed:

- Servicing and adjustment must only be performed by a certified Genelec service. The monitor enclosure or the RAM-XL amplifier unit must not be opened.
- Do not use this product with an unearthed mains cable or a mains connection without the protective earth contact as this may lead to personal injury.
- To prevent fire or electric shock, do not expose any part of the product to water

or moisture.

- Do not place any objects filled with liquid, such as vases on or near any part of the product.
- The "Woofers" and "Midrange/Tweeter" connectors on the RAM-XL amplifier can output hazardously high voltages. To ensure safety, the wiring connected to these connectors must be installed by a qualified and trained person.
- Note that the amplifier is not completely disconnected from the AC mains service unless the mains power cord is removed from the amplifier or the mains outlet. Easy access to either end of the power cord must be ensured at all times.
- Sufficient clearances and free flow of air around the RAM-XL amplifier as defined in chapters Amplifier Positioning and Operating Environment are necessary to maintain sufficient cooling.

Symbols



WEEE Directive 2012/19/EU



Power/standby switch

Compliance to FCC Rules

This device complies with part 15 of the FCC Rules. Operation is subject to the following two conditions:

- This device may not cause harmful interference, and
- This device must accept any interference received, including interference that may cause undesired operation.

Note: This equipment has been tested and found to comply with the limits for a Class B digital device, pursuant to part 15 of the FCC Rules. These limits are designed to provide reasonable protection against harmful interference in a residential installation. This equipment generates, uses and can radiate radio frequency energy and, if not installed and used in accordance with the instructions, may cause harmful interference to radio

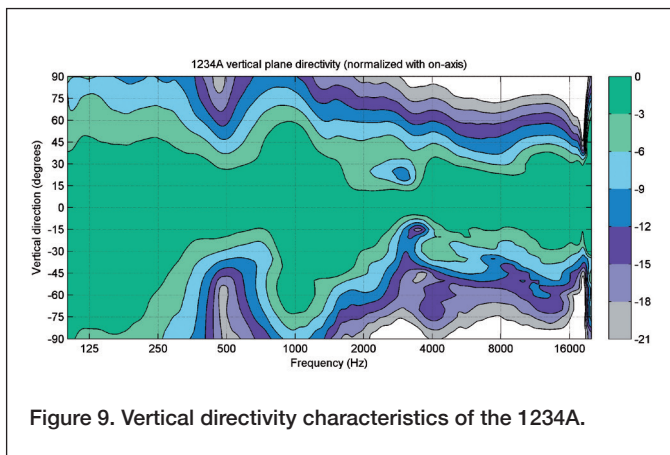

Figure 9. Vertical directivity characteristics of the 1234A.

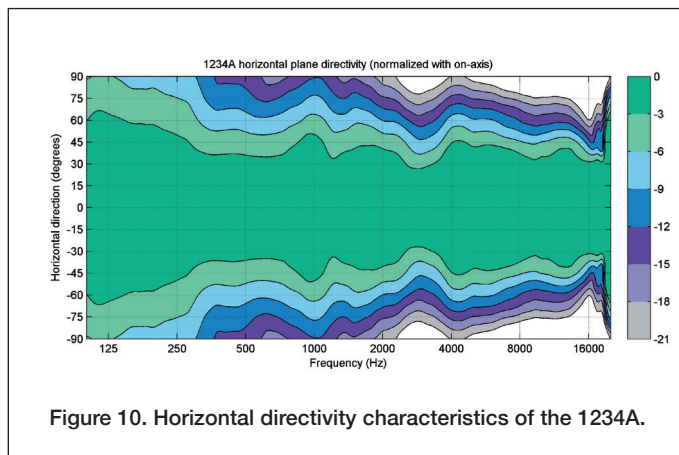

Figure 10. Horizontal directivity characteristics of the 1234A.

communications. However, there is no guarantee that interference will not occur in a particular installation. If this equipment does cause harmful interference to radio or television reception, which can be determined by turning the equipment off and on, the user is encouraged to try to correct the interference by one or more of the following measures:

- Reorient or relocate the receiving antenna.
- Increase the separation between the equipment and receiver.
- Connect the equipment into an outlet on a circuit different from that to which the receiver is connected.
- Consult the dealer or an experienced radio/TV technician for help.

Modifications not expressly approved by the manufacturer could void the user's authority to operate the equipment under FCC rules.

Guarantee

This product is guaranteed for a period of two years against faults in materials or workmanship. The guarantee can be extended by three years by registering the product at www.genelec.com. Refer to supplier for full sales and guarantee terms.

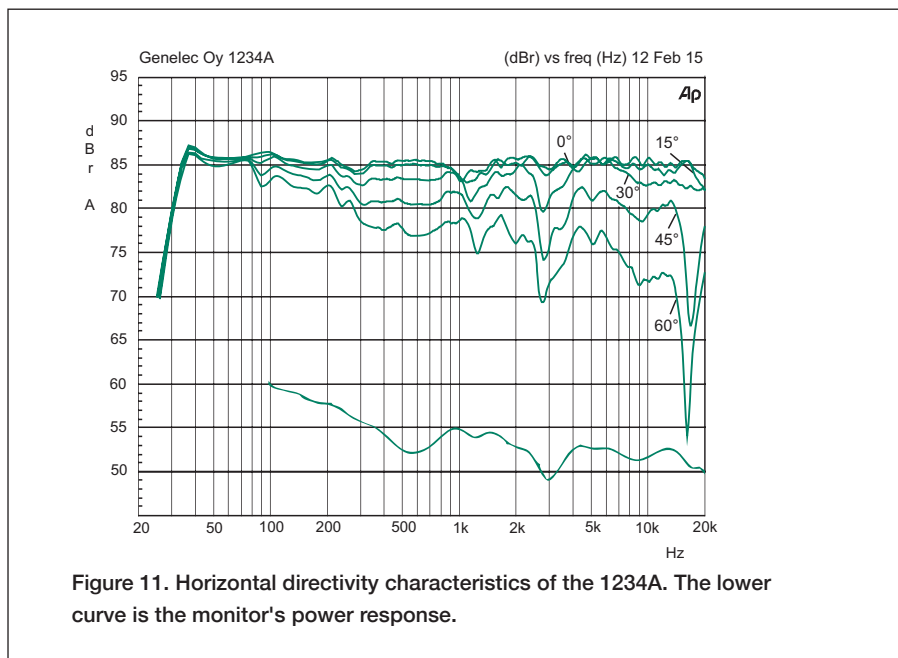

Figure 11. Horizontal directivity characteristics of the 1234A. The lower curve is the monitor's power response.

1234A Operating Manual

SYSTEM SPECIFICATIONS	
	1234A
Lower cut-off frequency, -6 dB	< 29 Hz
Upper cut-off frequency, -6 dB	> 21 kHz
Accuracy of frequency response, ± 2.0 dB	34 Hz – 20 kHz
Maximum short term sine wave acoustic output on axis in half space, averaged from 100 Hz to 3 kHz at 1 m	125 dB SPL
Maximum long term RMS acoustic output in the same conditions with IEC weighted noise (limited by driver protection circuit) at 1 m	120 dB SPL
Maximum peak acoustic output per pair in a listening room with music material at 2 m	130 dB
Self generated noise level in free space at 2 m on axis (A-weighted)	0 dB
Harmonic distortion at 95 dB SPL at 1 m on axis Freq: 50...200 Hz > 200 Hz	< 3 % < 0.5 %
Drivers Bass Midrange Treble	2 x 305 mm (12 in) cone 125 mm (5 in) cone 25 mm (1 in) metal dome
All drivers are magnetically shielded	
Monitor enclosure weight	73 kg (161 lb)
Amplifier weight	11.2 kg (25 lb)
Monitor enclosure dimensions Height Width Depth	700 mm (27 ⁹ / ₁₆ in) 890 mm (35 in) 383 mm (15 in)
Amplifier dimensions Height Width (front plate) Width (casing) Depth	3U 132 mm (5 ³ / ₁₆ in) 483 mm (19 in) 425 mm (16 ³ / ₄ in) 286 mm (11 ¹ / ₄ in)

AMPLIFIER SECTION	
	1234A
Bass amplifier short term output power	2 x 750 W
Midrange amplifier short term output power	400 W
Treble amplifier short term output power	250 W
Long term output power is limited by driver protection circuitry	
Amplifier system THD at nominal output	<0.003 %
Signal to Noise ratio, referred to full output Bass Midrange Treble	>116 dB >119 dB >115 dB
Mains voltage	100-120, 220-240 VAC 50/60 Hz
Power consumption Standby Idle Full output, long term Full output, peak	6 W 40 W 1000 W 2500 W

SIGNAL PROCESSING SECTION	
	1234A
Analog signal input connector XLR female, balanced 10 kOhm	pin 1 gnd pin 2 non-inverting, pin 3 inverting
Maximum analog input signal Analog input sensitivity (100 dB SPL at 1 m) Analog input gain selection	+25.0 dBu -6 dBu 0, +6, +12, +18 dB
Digital signal input connector XLR female 110 Ohm	AES/EBU Single Wire or Dual Wire
Digital signal output / Thru connector XLR male 110 Ohm	AES/EBU Single Wire or Dual Wire
Digital audio input Word length Sample rate Digital input sensitivity (100 dB SPL at 1 m) Digital input gain selection	16 - 24 bits 32 - 192 kHz -30 dBFS 0, +6, +12, +18 dB
Control network Type Connection	Proprietary GLM™ network 2 RJ45, CAT5 cables
Crossover frequency Bass/Mid Mid/Treble	420 Hz 3.2 kHz
GLM™ software frequency response adjustment Notch filters Shelving filters	4 LF and 2 HF 2 LF and 2 HF
System calibration	Genelec GLM AutoCal™

GENELEC®

International enquiries:
Genelec, Oivitie 5
FIN-74100, Iisalmi, Finland
Phone +358 17 83881
Fax +358 17 812 267
Email genelec@genelec.com

In the U.S. please contact:
Genelec, Inc., 7 Tech Circle
Natick, MA 01760, USA
Phone +1 508 652 0900
Fax +1 508 652 0909
Email genelec.usa@genelec.com

In China please contact:
Beijing Genelec Audio Co.Ltd
Room 101, 1st floor
Building 71 B33, Universal Business Park
No. 10 Jiuxianqiao Road, Chaoyang District
Beijing, China
Phone +86 (10) 5823 2014
Post code: 100015
Email genelec.china@genelec.com