

# DENON

*PROFESSIONAL*

## DN-900R

NETWORK SD/USB RECORDER

**User Guide**

English (5–77)

**Appendix**

English (78–80)

## Table of Contents

<b>Introduction</b> .....	5
Box Contents .....	5
Support .....	5
<b>Setup</b> .....	6
Required for Setup .....	6
System Connections Example .....	6
Audio Connections .....	7
Connecting the Power Cord .....	7
Inserting an SD Card .....	7
<b>Operation</b> .....	8
Preparing for Recording .....	8
Recording .....	9
Default Settings .....	9
Playing Back Recorded Files .....	10
<b>Features</b> .....	10
Front Panel .....	10
Rear Panel .....	11
<b>Display</b> .....	13
Display Properties (Playback/Pause/Search/Stop) .....	15
Display Properties (Recording/Paused) .....	16

**System Setting Menu** ..... 18

**Utility Menu** ..... 23

**Selecting Media** ..... 25

**Files and Folders**..... 26

    Selecting a File or Folder ..... 26

**Menu Operations**..... 30

**Preset Settings**..... 30

**Renaming Presets**..... 37

**Recording** ..... 38

    Operations During Recording ..... 42

**Playback** ..... 43

    Operations During Playback ..... 44

**Program List**..... 47

**Hot Start** ..... 50

**Editing Files** ..... 52

    Combine ..... 52

    Divide..... 52

    Copy ..... 53

    Move..... 54

    Undo..... 54

**Connecting to a Network** ..... 55

**Dante Connection** ..... 56

<b>Web Remote</b> .....	57
Password.....	57
Main Screen.....	58
Control Screen.....	59
Program Screen.....	62
File List Screen .....	63
Hot Start .....	64
System Setting Screen .....	65
Utility Screen .....	67
Preset Setting Screen.....	68
Play Timer .....	69
Record Timer .....	70
Archive Settings.....	71
Archive Files .....	73
<b>Serial Remote Control Function</b> .....	74
<b>Troubleshooting</b> .....	77
<b>Appendix (English)</b> .....	78
<b>Technical Specifications</b> .....	78
<b>Trademarks &amp; Licenses</b> .....	80

## User Guide (English)

### Introduction

Thank you for purchasing the DN-900R. At Denon Professional, performance and reliability mean as much to us as they do to you. That's why we design our equipment with only one thing in mind—to make your performance the best it can be.

### Box Contents

DN-900R

Power Cable

Quickstart Guide

(4) Security screws for SD card door

Safety & Warranty Manual

### Support

For the latest information about this product (documentation, technical specifications, system requirements, compatibility information, etc.) and product registration, visit [denonpro.com](https://denonpro.com).

For additional product support, visit [denonpro.com/support](https://denonpro.com/support).

## Setup

### Required for Setup

Items not listed under [Introduction > Box Contents](#) are sold separately.

- SD Card
- USB device
- Headphones
- Microphones
- PC
- Modem
- Router
- Server (NAS/FTP)
- Audio cable (XLR/RCA)
- Serial Remote Controller (RS-232C Straight cable)
- Screws for mounting the DN-900R on a rack

### System Connections Example

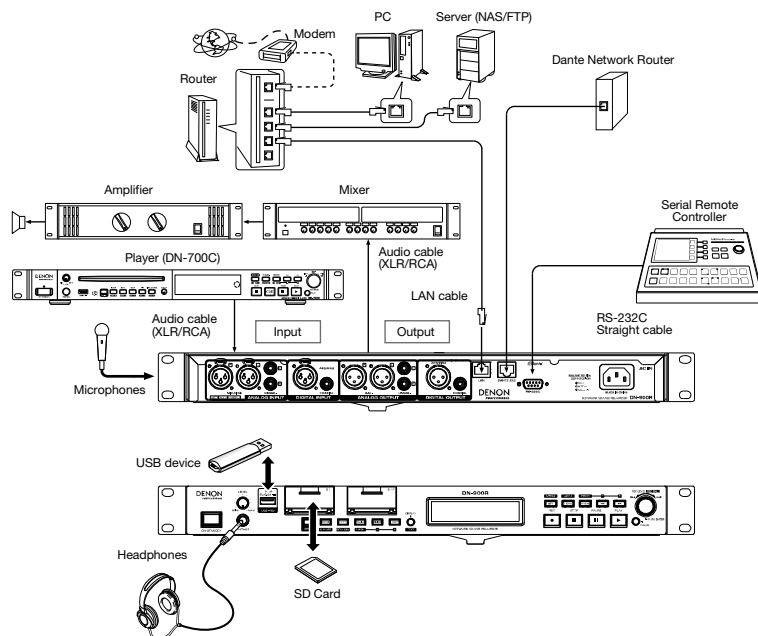

## Audio Connections

### Analog Connection (Balanced Connection)

Connect line-level analog inputs/outputs to the analog (balanced) input/output terminals for playback or recording.

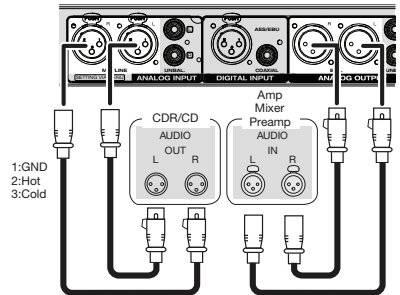

### Connecting the Power Cord

Insert the power cord when all other connections are completed. Be sure to connect the ground wire also.

#### Notes:

- Be sure to insert the power plug firmly into the AC outlet. If the plug is not properly inserted, it could cause a malfunction or noise.
- Do not unplug the power cord while the unit is operating.
- Do not use a power cord other than the cord supplied with this unit.

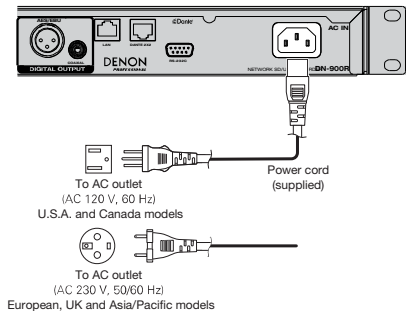

### Inserting an SD Card

1. Open the SD card door in the direction indicated by the arrow. The screen will display **SD# DOOR OPEN** (where # is the selected SD card slot number).
  2. The SD card can only be inserted one way – label up and connector first. Insert the SD card fully into the SD card slot until a "click" sound is heard.
  3. Close the SD card door.
- If the SD card door does not close with a "click," check that the SD card is fully inserted into the slot.

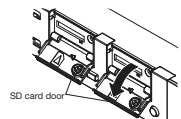

SD card door

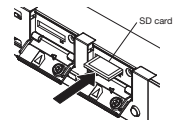

SD card

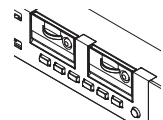

## Operation

### Preparing for Recording

#### Note:

- Be sure to set the clock before use.
- Before recording to an SD card, format the SD card on this unit.

#### To open the Utility menu

1. Press the **power switch** to turn on DN-900R.
2. While playback/recording is stopped, press **Menu** to display the menu list.
3. Turn the **jog dial** to select **Utility** and press **Enter**.

#### To set the Time/Date

1. Press **Menu** to display the menu list.
2. Select **Utility** and turn the **jog dial** to select **Time/Date**, then press **Enter**.
3. Turn the **jog dial** to select the input position (year/month/day/hour/minute), and press **Enter**.
4. Turn the **jog dial** to change the setting, then press **Enter** to confirm.
5. When all settings have been entered, they will be automatically saved and the **Utility** menu will be displayed. If only some of the settings have been changed, but not all, press **Back** twice. **Fix** and **Discard** will be shown on the display.
6. Turn the **jog dial** to select **Fix** and press **Enter** to confirm the settings. Select **Discard** to discard the changes.

#### To format an SD card

1. Press **Menu** to display the menu list.
2. Select **Utility** and turn the **jog dial** to select **Format Media**, then press **Enter**. The list of media devices will be shown on the display.
3. Turn the **jog dial** to select the desired media, then press **Enter**.
4. Turn the **jog dial** to select **OK**, then press **Enter**.  
**Formatting** will be shown on the display during formatting, and **Completed** will be shown when the formatting is complete.

You can also perform a speed check to test the read and write speed of the currently used media.

1. Press **Menu** to display the menu list.
2. Select **Utility**, then select **Speed Check**. A list of media devices will be shown on the display.
3. Turn the **jog dial** to select the desired media, then press **Enter**.
4. Rotate jog dial to highlight **OK** and press **Enter** to confirm selection.



5. When the check is complete, one of the following results will appear:
  - **Good:** The checked media is suitable for use.
  - **Good w/o Rec Mon:** The checked media is suitable for simple recording, but is unsuitable for record monitoring.
  - **Poor:** The checked media is unsuitable for use.
6. Select **OK** to end the test.

## Recording

1. Press the **Record** button. The unit will switch to a record paused state and the Record button will flash.
2. Use the jog dial to adjust the recording level. Hold the **Shift** button and use the jog dial to adjust the recording balance.
3. Press the **Record** button to begin recording.
 

The file name of the recording includes the UPnP (Universal Plug and Play) device name, the recording start time, and user area data.

The file creation formats can be selected in **System Setting > File Name Form**. The file name can be inputted when **System Setting > User Area** is **On**. After recording has started, the recording start time in the file name continues to proceed until the recording start time is confirmed.
4. Press **Stop** to turn off recording.

## Default Settings

The main default settings for DN-900R are as shown below.

Preset Setting	
One Touch Record	Off
Audio Input	Bal
Record Format	MP3-320
Record Channel	Stereo
Sample Rate	44.1k
Silent Skip	Off
Play Range	Folder
Play Mode	Continuous

System Setting	
Record Folder	Current
Signal Pass Through	On
Output Rate	Auto
Line/Mic Lch	Line
Line/Mic Rch	Line
Serial Bit Rate	9600

## Playing Back Recorded Files

1. Press **Play** to start playback.
2. To pause playback, press the **Pause** button. When Play is pressed again, playback will resume.
3. To stop playback, press the **Stop** button.

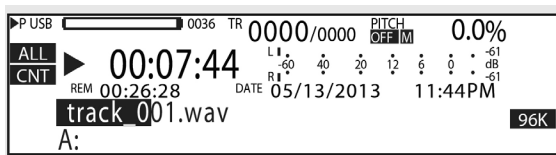

## Features

### Front Panel

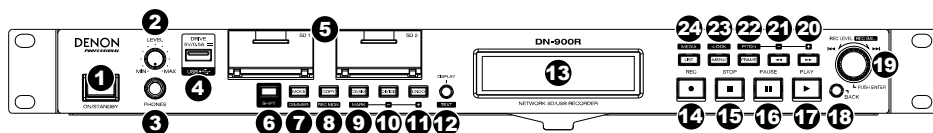

1. **Power Switch:** Press this switch to turn DN-900R on/off. The unit will go into Network Standby mode when powered on for low power operation with network access (if previously enabled in the System Setting menu). If Network Standby is not enabled in System Setting, the unit will go into Standby mode without network access when powered on. Make sure the **AC Input** is properly connected to a power outlet. Do not turn the unit off during media recording or playback—doing so could damage your media.
2. **Headphone Level:** Turn this knob to adjust the level of the **headphone output**.
3. **Headphone Output:** Connect headphones to this 1/4" (6.35 mm) TRS output.
4. **USB Drive Port:** Connect a mass-storage-class USB device to this port.
5. **SD Card Slots:** Open the security doors to insert an SD/SDHC card into the slot. The doors can be fastened for security by removing the plastic pin retainers and inserting the included screws.
6. **Shift:** Press this button to access secondary functions, printed under each button.
7. **Move/Dimmer:** Press this button to move the file of the current track. Hold **Shift** and press this button to change the brightness of the display and LEDs.
8. **Copy/Rec Mon:** Press this button to copy the file of the selected track. Hold **Shift** and press this button to turn the recording monitor on or off.
9. **Combine/Mark:** Press this button to combine the selected track with another track. Hold **Shift** and press this button to add a mark to the current playback or recording position.
10. **Divide/Mark →:** Press this button to divide the selected track at the current playback or recording position. Hold **Shift** and press this button to jump to the mark prior to the current playback position.

11. **Undo/Mark +:** Press this button to undo the last edit. Hold **Shift** and press this button to jump to the next mark after to the current playback position.
12. **Display/Text:** Press this button to change the view on the display. Hold **Shift** and press this button to scroll text on the display.
13. **Display:** This screen indicates the unit's current operation. See **Display** for more information.
14. **Record:** Press this button to start or prepare for recording. The button will be lit when recording, and flashing when recording is paused.
15. **Stop:** Press this button to stop playback or recording.
16. **Pause:** Press this button to pause playback or recording.
17. **Play:** Press this button to start playback.
18. **Back:** Press this button to return to the previous menu. When viewing the file list, hold **Shift** and press this button to move the cursor to the top of the list.
19. **Jog Dial/Enter:** During playback, turn this dial to skip tracks. Press this dial to confirm a menu selection. When stopped, hold **Shift** and turn the jog dial to adjust the recording level or recording balance. Select whether the Shift function controls the recording level or recording balance from the **Preset Setting > Rec Level Type** menu.
20. **Fast Forward/Pitch +:** Press this button to fast forward the track. In Frame mode, press this button to jump forward by frames. Hold **Shift** and press this button to set the pitch.
21. **Rewind/Pitch -:** Press this button to rewind the track. In Frame mode, press this button to jump backward by frames. Hold **Shift** and press this button to set the pitch.
22. **Frame/Pitch:** Press this button to switch the function of the **Fast Forward** and **Rewind** buttons between Frame mode and Search mode. Hold **Shift** and press this button to turn **Pitch** control on or off.
23. **Menu/Lock:** Press this button to open the menu. To restrict key use, hold the **Shift** button, then hold the **Menu/Lock** button for about 1 second until "keys restricted" is displayed on the screen. Once keys are restricted, hold the **Shift** button, then hold the **Menu/Lock** button for about 1 second until "All Keys Locked" is displayed on the screen. Once all keys are locked, hold the **Shift** button, then hold the **Menu/Lock** button for about 1 second until "All Keys Unlocked" is displayed on the screen.
24. **List/Media:** Press this button to show the file list on the display. Hold **Shift** and press this button to show the media list on the display.

## Rear Panel

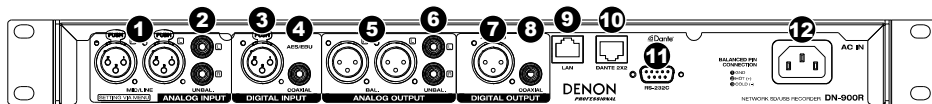

1. **Analog Input, Balanced XLR:** Use standard XLR cables to connect these inputs to your sound source, such as a microphone.
  2. **Analog Input, Unbalanced RCA:** Use standard RCA stereo cables to connect these inputs to your sound source, such as a CD player.
  3. **Digital Input, Digital XLR:** Use a digital XLR cable (IEC60958 Type I, AES/EBU) to connect this input to your sound source.
  4. **Digital Input, Digital RCA:** Use digital RCA cables (IEC60958 Type II, S/PDIF coaxial) to connect this input to your sound source.
  5. **Analog Output, Balanced XLR:** Use standard XLR cables to connect these outputs to external speakers, a sound system, etc.
  6. **Analog Output, Unbalanced RCA:** Use standard RCA stereo cables to connect these outputs to external speakers, a sound system, etc.
  7. **Digital Output, Digital XLR:** Use a digital XLR cable (IEC60958 Type I, AES/EBU) to connect this output to your sound system.
  8. **Digital Output, Digital RCA:** Use digital coaxial RCA cables (IEC60958 Type II, S/PDIF coaxial) to connect this output to your sound system.
  9. **LAN Port:** Use a standard Ethernet cable (IEEE 802.3u (3.3V I/O) / 10/100 Base-T(X) / RJ-45) to connect this port to a network switch or router.
  10. **Dante Port:** Use a standard Ethernet cable to connect DN-900R to a Dante network from this port. Dante channel routing is set using the Dante Control software, available for download at [audinate.com/products/software/dante-controller](http://audinate.com/products/software/dante-controller).
  11. **RS-232C Terminal:** Use a 9-pin D-sub connector to connect a host device such as a computer to DN-900R to control it using serial commands.
- Note:** Visit the DN-900R product page at [denonpro.com](http://denonpro.com) to download the *Serial Protocol Guide* for more information.
12. **AC Input:** Use the included power cable to connect this input to a power outlet.

## Display

The playback status and information about various media is displayed on the DN-900R display. Details of the display differ depending on the operating status (stopped/recording/playing) of the DN-900R.

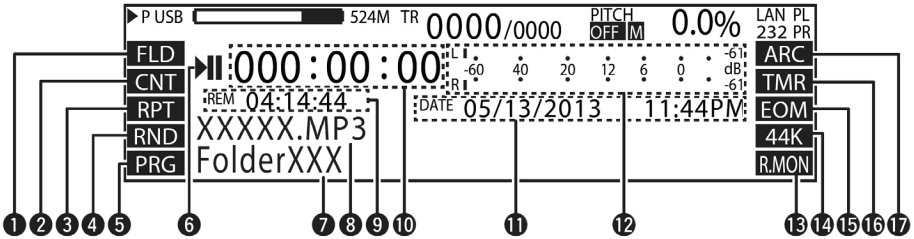

1. **Playback Range:** Displays the current playback range, with the configured settings selected in **Preset Setting > Play Range**. Select **FLD** to display the current folder; select **ALL** to display all folders.
2. **Playback Mode:** Displays the settings configured in **Preset Setting > Play Mode**. Select **CNT** for continuous playback; select **SGL** for single track playback.
3. **Repeat Playback:** Displays the settings configured in **Preset Setting > Repeat**. Select **RPT** to display repeat playback.
4. **Random Playback:** Displays the settings configured in **Preset Setting > Random**. Select **RND** to display random playback.
5. **Programmed Playback:** Displays the settings configured in **Preset Setting > Program**. Select **PRG** to display programmed playback.
6. **Status:** Displays the operating status.

Stop	■
Cue	■ CUE
Pause	
Audible Pause	▶
Search	◀ ▶ ▶ ▶
Play	▶
Record Pause	•
Record	•

7. **Folder Name:** Displays the path to the selected folder.
8. **Track Name:** Displays the selected track name.

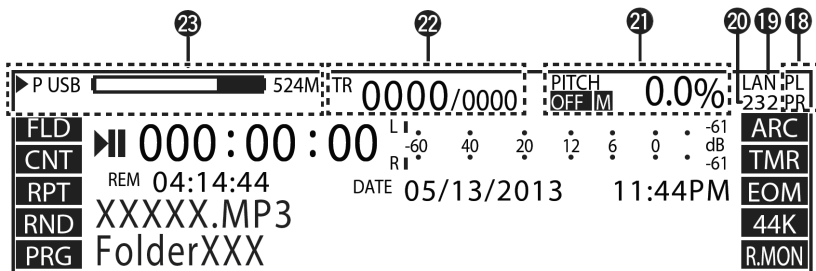

9. **Remaining Time:** Displays the remaining time for the current track. The display format can be set in **Preset Setting > Time Display**. When the selected track is VBR (Variable Bit Rate) format, the estimated remaining time is displayed.
10. **Elapsed Time:** Displays the elapsed time for the currently selected track. The display format can be set in **Preset Setting > Time Display**.
11. **Time/Date:** Displays the current date and time when playback is stopped. During playback, the date and time when the selected track was created are displayed. The display format can be set in the **System Setting** menu.
12. **Playback Level:** Displays the playback level with a three-second peak hold.
13. **Recording Monitor:** Displays the recording's monitor status. "R.MON" is displayed when the recording monitor is on.
14. **Sampling Rate:** Displays the sampling rate of the audio output ("44k", "48k", "96k"). When EXT is selected, the system uses the recovered (AES/EBU) clock as the system sample rate, and **EXT** flashes in the display.
15. **End of Track Notification:** "EOM" is displayed when nearing the end of the playback track.
16. **Timer Display:** "TMR" flashes while executing a Timer playback or Timer record.
17. **Archive Display:** "ARC" is displayed when a setting other than Off is set in **Archive Setting > Archive Mode**. "ARC" flashes while archiving is being executed.
18. **Phantom Power:** Displayed when the phantom power setting is turned on in **System Setting > Phantom Lch (PL)** and **System Setting > Phantom Rch (PR)**.
19. **Ethernet:** Displayed when the Ethernet port is in use.
20. **Remote Serial Connection:** Displayed when remote serial commands are being received.
21. **Pitch:** Displays the On/Off status of the pitch function, master key, and playback speed (percentage). "M" is displayed when the master key is on.
22. **Track Number:** The right side displays the total number of tracks on the selected media, and the left side displays the selected track number.
23. **Media display:** Displays the type of currently selected media (SD1/SD2/USB/NET) and the amount of free space. The currently selected media is set in the upper part with "P" displayed in front of the media. The backup media (dual recording) is set in the lower part (when applicable) with "B" displayed in front of the media. When a secondary media (relay recording) is set, "S" is displayed in front of the media. "1" indicates the currently selected media. If there is no free space on the selected media, "Media Full" is displayed. If the media reaches 2000 tracks, "Track Full" is displayed. If writing is prohibited to the media, "Write Lock" is displayed. The free space is not displayed when the media is "Net".

**Display Properties (Playback/Pause/Search/Stop)**

	Property
①	0001 BGM_001.mp3( /Full/Path)
②	01/02/2013 10:23:45AM
③	44K Mo 320kbps
④	"Artist"

1. **Track Number/File Name:** Displays the selected track number and file name. The path to the folder in which the file is stored is displayed in parentheses.
2. **Date/Time Display:** Displays the date and time when the selected track was created. The display format can be set in the **System Setting** menu.
3. **Track Recording Information:** Displays the sampling rate, channel, St: stereo / Mo: monaural, and bit rate.
4. **Artist Name:** The artist name within the ID3 tag is displayed for MP3 files.

**Note:** If the text information does not fit in the display, hold **Shift** and press **Text** to scroll and display the hidden text.

## Display Properties (Recording/Paused)

Press **Display** to switch to an enlarged level meter display.

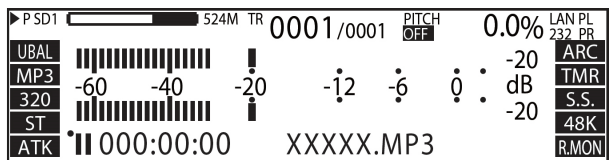
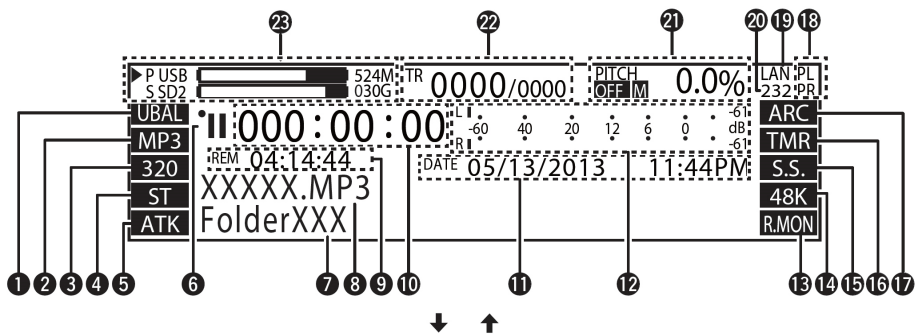

- Recording Input:** Displays the selected **Preset Setting > Audio Input**. Select from **UBAL:** Unbalanced / **BAL:** Balanced, **AES:** AES/EBU, **Dante:** Dante Network, and **COAX:** Coaxial.
- Recording File:** Displays the selected **Preset Setting > Rec Format**. Select from MP3 and WAV.
- Recording Format:** Displays the **Preset Setting > Rec Format**. Select from **MP3:** Bit rate and **WAV:** Number of quantization bits.
- Recording Channel:** Displays the **Preset Setting > Rec Channel**. Select from **ST:** Stereo, **MONO:** Mono (LCh), and **MIX:** LCh RCh Mix.
- Auto Track:** Displays ATK when **Preset Setting > Auto Track** is on.
- Status Display:** Displays the operating status.

Stop	■
Cue	CUE
Pause	
Audible Pause	▶
Search	◀◀▶▶
Play	▶
Record Pause	•
Record	•



7. **Folder Name:** Displays the path to the selected folder.
8. **Track Name:** Displays the progress bar when set to anything other than off in the **Auto Track > Preset Setting**.
9. **Remaining Time:** Displays the remaining recordable time on the selected media. The display format can be set in **Preset Setting > Time Display**. “---:--:---” is displayed if the format cannot be applied to the remaining time display.
10. **Elapsed Time:** Displays the elapsed recording time for the current track. The display format can be set in **Preset Setting > Time Display**.
11. **Time/Date:** The recording start date and time are displayed during the recording operation.
12. **Recording Level Meter:** Displays the recording level with a 3 second peak hold.
13. **Recording Monitor:** Displays the recording’s monitor status. “R.MON” is displayed when the recording monitor is on.
14. **Recording Sample Rate:** The current sample rate is displayed here. When a sampling rate is not applied when Ext (AES/EBU) is used, “EXT” flashes on the display. The recording sample rate is set in **Preset Setting > Sample Rate**.
15. **Silent Skip:** Displays “S.S.” when turned on in the **Preset Setting > Silent Skip** menu.
16. **Timer:** “TMR” is displayed when the **Preset Setting > Rec Timer** or **Preset Setting > Play Timer** is set.
17. **Archive:** “ARC” is displayed when a setting other than “Off” is set in **Archive Setting > Archive Mode**. “ARC” will flash while archiving is being executed.
18. **Phantom Power:** Displayed when phantom power is on. Select this in **System Setting > Phantom Lch (PL)** and **System Setting > Phantom Rch (PR)**.
19. **Ethernet:** Displayed when the Ethernet is in use.
20. **Remote Serial Connection:** Displayed when the remote serial command is being received.
21. **Pitch:** Displays the On/Off status of the pitch function, master key, and playback speed (percentage). “M” is displayed when the master key is on.
22. **Track Number:** The right side displays the total number of tracks on the selected media, and the left side displays the selected track number.
23. **Media display:** Displays the type of currently selected media (SD1/SD2/USB/NET) and the amount of free space. “1” indicates the currently selected media. The currently selected media is set in the upper part and “P” is displayed in front of the media. The backup media (dual recording) is set in the lower part (when applicable) and “B” is displayed in front of the media. When a secondary media (relay recording) is set, “S” is displayed in front of the media. If there is no free space on the selected media, “Media Full” is displayed. If the selected media reaches 2000 tracks, “Track Full” is displayed. If writing is prohibited to the selected media, “Write Lock” is displayed. The free space is not displayed when the media is “Net”.

## System Setting Menu

**Timer Priority:** Sets the priority for timer playback.

- **Off:** Timer playback only starts in the standby, stop, or cue state.
- **On:** Timer playback starts any time other than when recording.

**Rec Folder:** Sets the folder where data is saved when recording.

- **Current:** Recorded data is saved into the currently selected folder.
- **Fixed:** Recorded data is saved into a fixed folder directly below the root folder.

A folder is automatically created if there is no folder, with the default folder name “DMH\_REC”.

**Note:** When Play Range in the Preset Setting menu is set to “All”, data is saved to the root folder.

**Signal Pass Thru:** Sends the input signal to the audio outputs when recording or when recording is paused. The input signal will always be heard from the headphone output regardless of the Signal Pass Thru setting.

- **Off:** The input signal is not passed through to the audio outputs.
- **On:** The input signal is passed through unchanged to the audio outputs.

**User Area:** Sets the character string (user area) added to the recorded file name.

- **Off:** User area is not used.
- **On:** User area is used.

**File Name Form:** Sets the file name creation format when recording.

- **MN\_DT\_UA:** Machine name\_recording start time\_user area.zzz
- **MN\_UA\_DT:** Machine name\_user area\_recording start time.zzz
- **DT\_MN\_UA:** Recording start time\_machine name\_user area.zzz
- **DT\_UA\_MN:** Recording start time\_user area\_machine name.zzz
- **UA\_MN\_DT:** User area\_machine name\_recording start time.zzz
- **UA\_DT\_MN:** User area\_recording start time\_machine name.zzz

**Mono Play:** Sets monaural playback.

- **Off:** Channels are output based on the input source.
- **On:** Channels are summed and output as monaural.

**Output Rate:** Sets the sampling rate for the audio.

- **Auto:** Audio output is based on the rate of the input media or file.
- **44.1k:** Audio is output at 44.1 kHz.
- **48k:** Audio is output at 48 kHz.
- **Ext (AES):** Uses an external clock (AES/EBU) to output audio.

**Note:** When the external clock is 96 kHz, audio is output according to the sampling rate of the playback file if the playback file has a sampling rate other than 96 kHz.

**Note:** DN-900R converts the output sample rate sent to Dante back to the Dante sample rate.

**Line/Mic Lch:** Sets the mode for the XLR left channel.

- **Line:** Set to the line input.
- **Mic:** Set to the microphone input.

**Line/Mic Rch:** Sets the mode for the XLR right channel.

- **Line:** Set to the line input.
- **Mic:** Set to the microphone input.

**Phantom Lch:** Sets phantom power (+48V) for the Line/Mic Lch.

- **Off:** Turns phantom power off for the left channel.
- **On:** Turns phantom power on for the left channel. However, when Line/Mic Lch is set to **Line**, phantom power will be off.

**Phantom Rch:** Sets phantom power (+48V) for Line/Mic Rch.

- **Off:** Turns phantom power off for the right channel.
- **On:** Turns phantom power on for the right channel. However, when Line/Mic Rch is set to **Line**, phantom power will be off.

**Mic In Sens Lch:** Adjusts the XLR mic input sensitivity for the left channel in 1 dBu increments.

- **-16 dBu / -40 dBu / -60 dBu**

**Mic In Sens Rch:** Adjusts the XLR microphone input sensitivity for the right channel in 1 dBu increments.

- **-16 dBu / -40 dBu / -60 dBu**

**Volume Input:** Sets the analog recording input level.

- **Fixed (0 dB):** The recording input level is fixed at 0 dB.
- **Variable:** The recording input level may be adjusted from **-60 / 0 / 10 dBu** in 0.1 dB increments.

**Ref (XLR/RCA):** Sets the input/output standard level.

- **+24 dBu/+10 dBV:** XLR = +24 dBu / RCA = +10 dBV
- **+20 dBu/+6 dBV:** XLR = +20 dBu / RCA = +6 dBV
- **+18 dBu/+4 dBV:** XLR = +18 dBu / RCA = +4 dBV

**Input Trim Lch:** Adjusts the analog input for the left channel in 0.1 dB increments.

- **+2.0 dB / 0 dB / -2.0 dB**

**Input Trim Rch:** Adjusts the analog input for the right channel in 0.1 dB increments.

- **+2.0 dB / 0 dB / -2.0 dB**

**Output Trim Lch:** Adjusts the analog output for the left channel in 0.1 dB increments.

- **+2.0 dB / 0 dB / -2.0 dB**

**Output Trim Rch:** Adjusts the analog output for the right channel in 0.1 dB increments.

- **+2.0 dB / 0 dB / -2.0 dB**

**Time Form:** Sets the type of the current time display.

- **12h:** Switches to the 12-hour display (AM/PM).
- **24h:** Switches to the 24-hour display.

**Date Form:** Sets the display order of the date.

- **MDY:** Displays the date in Month/Day/Year order.
- **DMY:** Displays the date in Day/Month/Year order.
- **YMD:** Displays the date in Year/Month/Day order.

**Display Contrast:** Sets the contrast of the display.

- **1 - 5:** 1 is the darkest, 5 is the brightest.

**Serial Bit Rate:** Sets the serial communication bit rate for RS-232C.

- **9600:** 9600 bps
- **38400:** 38400 bps

**Machine Name:** Displays the UPnP device name (maximum 12 characters).

**IP Address**

- **Auto:** DHCP is assigned automatically.
- **Static:** Specify a fixed IP address to be displayed.

**Subnet Mask**

- **None:** The Subnet Mask is not displayed when the IP Address is set to **Auto**. It can be set for any setting other than Auto.
- **Static:** 0.0.0.0 to 255.255.255.255. (When Auto is set: 255.255.255.0)

**Gateway**

- **None:** The Gateway is not displayed when the IP Address is set to **Auto**. It can be set for any setting other than Auto.
- **Static:** 0.0.0.0 to 255.255.255.255. (When Auto is set: 0.0.0.0)

**DNS Server**

- **None:** The DNS is not displayed when the IP Address is set to **Auto**. It can be set for any setting other than Auto.
- **Static:** 0.0.0.0 to 255.255.255.255. (When Auto is set: 0.0.0.0)

**IP Control Port:**

- **0 to 65535:** Sets the IP control port number.

**IP Control Auth**

- **Off:** Password authentication is not required for IP control.
- **On:** Password authentication is required for IP control.

**Network Standby**

- **Off:** The Power switch will put the unit in a very low power mode with no network access.
- **On:** The Power switch will put the unit in a low power mode with network access.

**NTP:** Displays the NTP server address. Press **Enter** to enter the address. Then select the cycle of NTP.

- **Off:** NTP is not used.
- **On:** NTP is used.

**Syslog:** The Syslog server address is displayed. Press **Enter** to enter the address.

- **Off:** Event information is not sent to the server.
- **On:** Event information is sent to the server.

**Time Zone:** Set the offset time in 15-minute increments.

- **-12:00 - +14:00 (00:00)**

**Daylight Saving:** Sets daylight saving time.

- **Off:** Daylight saving time is not applied.
- **On:** Daylight saving time is applied.

Set the start and end date of daylight saving time and the offset time of up to six hours in 15-minute increments.

**Admin Passwd:** Sets the Admin Password for when Web Remote, IP Control, or System Setting is used.

- **\*\*\*\*:** Set the password between 6 to 12 characters.

**Operator Passwd:** Sets the Operator Password for when Web Remote or IP Control is used.

- **\*\*\*\*:** Set the password between 6 to 12 characters.

**Observer Passwd:** Sets the Observer Password for when Web Remote or IP Control are used.

- **\*\*\*\*:** Set the password between 6 to 12 characters.

#### **Auto Reboot**

- **Off:** Does not automatically reboot.
- **On:** Reboots automatically if the main processor freezes.

**Default:** Resets all of the system settings to the defaults.

#### **Auto Power Off**

- **Off:** No Auto Power Off
- **On:** Unit will automatically power off after 30 minutes of inactivity if Network Standby is off.

**Dante Reset:** Performs a factory reset and reboot of the Dante device wiping:

- User-defined device name
- User-defined channel labels
- Clock configuration (clock master / external clock master setting)
- Static IP addresses
- Sample rate setting (including pull-up/down)
- Latency setting
- Any existing audio routes

## Utility Menu

**Time/Date:** Set the current time and date. The time must be set before using the unit because the set time is used as the recorded file name. If the unit is connected to a network and **System Setting > NTP** is set to **On**, the current time settings do not need to be configured.

### To set the Time/Date

1. Press **Menu** to display the menu list.
2. Select **Utility** and rotate the **jog dial** to select Time/Date, then press **Enter**.
3. Rotate the **jog dial** to select the input position (year/month/day/hour/minute), and press **Enter**.
4. Rotate the **jog dial** to select the setting item, and press **Enter**.
5. Select the time display type (12-hour display/24-hour display) in **System Setting > Time Form**.
6. Select the display order for the date (year/month/date) in **System Setting > Date Form**.

When all settings are entered, they will automatically be saved in the **Utility** menu.

### To cancel Time/Date changes

1. Press **Back** twice.
2. Rotate the jog dial to select **Discard**, and press **Enter**.

**Load Setting:** Reads the preset setting file stored in the root directory of the currently used media (SD1/SD2/USB), and changes the settings of the unit accordingly.

1. Press **Menu** to display the menu list.
2. Select **Utility** and rotate the **jog dial** to select **Load Setting**, then press **Enter**.
3. Select **OK** with the **jog dial** when “Load Preset?” is displayed, then press **Enter**.

The “DN-xxxx.ini” file on the currently used media is read, and the unit’s settings are updated.

When the update is finished, “Completed” is displayed.

**Save Setting:** Saves the current preset settings in the root directory of the currently used media (SD1/SD2/USB).

1. Press **Menu** to display the menu list.
2. Select **Utility** and rotate the **jog dial** to select **Save Setting**, then press **Enter**.
3. Select **OK** with the **jog dial** when “Save Preset?” is displayed, then press **Enter**.

The “DN-xxxx.ini” file is saved in the root directory of the currently used media. When the update is finished, “Completed” is displayed.

**Firmware Version:** Displays the firmware version of the device.

1. Press **Menu** to display the menu list.
2. Select **Utility** and rotate the **jog dial** to select **Firmware Version**, then press **Enter** to view the firmware version.

**Network Status:** Displays network setting information.

1. Press **Menu** to display the menu list.
2. Select **Utility** and rotate the **jog dial** to select Network Status, then press **Enter**. Network IP/Mask, MAC, Gateway, and DNS are displayed.

**Dante Status:** Displays network setting information.

1. Press **Menu** to display the menu list.
2. Select **Utility** and rotate the **jog dial** to select **Dante Status**, then press **Enter**. Dante Name, IP/Mask, MAC, and connection Status are displayed.

**Format Media:** Erases the SD card.

1. Press **Menu** to display the menu list.
2. Select **Utility** and turn the **jog dial** to select **Format Media**, then press **Enter**. The list of media devices will be shown on the display.
3. Turn the **jog dial** to select the desired media, then press **Enter**.
4. Turn the **jog dial** to select **OK**, then press **Enter**.

**Formatting** will be shown on the display during formatting, and **Completed** will be shown when the formatting is complete.



**Speed Check:** Checks the selected media to verify the media is suitable for recording.

1. Select **OK** with the **jog dial**, and press **Enter**. Media check starts and “Check Speed ...” is displayed.

The following results are displayed when the speed check is complete.

- **Good:** The checked media is suitable for recording.
  - **Good w/o Rec Mon:** The checked media is suitable for recording but is unsuitable for monitoring the audio while recording.
  - **Poor:** The checked media is unsuitable for recording.
2. Select **OK** and press **Enter**.

## Selecting Media

### Displaying the media list and selecting media

1. When in the stopped state, hold down **Shift** and press **Media**. The media list is displayed.
  - **Current:** The currently selected media is shown.
  - **Dual:** Backup media is shown as set in **Preset Setting > Dual Rec.**
  - **Relay:** Secondary media is shown as set in **Preset Setting > Relay Rec.**
2. Rotate the **jog dial** to select the media, and press **Enter**. The selected media becomes the currently selected media, and the unit returns to the stopped state.

### Displaying and selecting a media server

1. When in the stopped state, hold down **Shift** and press **Media**. The media list is displayed.
2. Rotate the **jog dial** to select **Net**, and press **Enter** to display the media server list.
3. Rotate the **jog dial** to select the media server or PC to playback, and press **Enter**.

#### Notes:

- When playing back from a media server, playback operates using the “Folder” setting even if **Preset Setting > Play Range** is set to “All”.
- Data cannot be recorded to a media server or PC on the network.

The following restrictions apply to files and folders on the network:

- Files cannot be deleted/divided/merged and folders cannot be created/moved/deleted.
- File names/folder names cannot be changed.
- Files cannot be moved from the network to media connected to the unit.
- Folders cannot be copied from media connected to the unit to the network.

## Files and Folders

The file list shows the folders and files that may be selected. You can also perform file management operations, check file information, change file names, and delete, copy, and move files.

### Selecting a File or Folder

1. Press **List** when the playback screen is displayed. The file list is displayed.
2. Use the **jog dial** to select **Up One Level** for the parent folder and press **Enter** to display the file list in the folder one level above.
3. Use the **jog dial** to select the folder and press **Enter** to display the file list in the selected folder.
4. Use the **jog dial** to select a file and press **Enter** to close the file list and cue the start of the selected file. Press **Back** in the menu display to return to the previous screen.
5. Press **List** to exit file/folder selection and return to the stopped status.

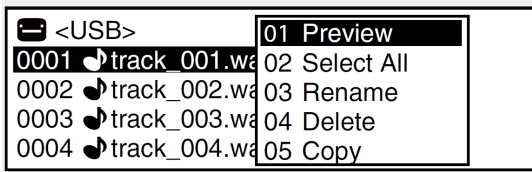

### File List Menu

Display	Function
<b>01 Preview</b>	Previews just one track of the selected file
<b>02 Select All</b>	Selects all files in the list
<b>03 Rename*</b>	Changes the file name or folder name
<b>04 Delete</b>	Deletes selected files or folders
<b>05 Copy*</b>	Copies selected files or folders
<b>06 Move*</b>	Moves selected files or folders
<b>07 Make Folder</b>	Creates a new folder
<b>08 Delete Mark</b>	Deletes all marks from the selected file
<b>09 Property</b>	Displays information for the selected file

\* **Undo** may be used directly after editing to return the edit to the previous state.

## Playing Files (Preview)

### To play a preview of the selected file

1. Rotate the **jog dial** to select **Preview**, and press **Enter**.
2. Press **Stop** or **Enter** to stop playback and return to the file list menu.

### Selecting all files for copying, moving, or deleting

Rotate the **jog dial** to select **Select All**, and press **Enter**. All files are selected and the display returns to the file list. Check marks are added to the front of the files.

If all files were selected, this deselects all files. If the folder is changed, the selected state is cleared.

### Selecting multiple files to copy, move, or delete

In the file list, hold down **Shift** and press **Enter**. The file or folder on the cursor is selected and a check mark is added in front of it.

Only files within the same folder may be selected. To deselect a file or folder, perform the selection operation again.

### Renaming the file name or folder name

1. Select **Rename** in the folder list menu, and press **Enter**. Up to 252 characters may be entered.
2. Place the cursor in the position to insert characters using the << and >> buttons.
3. Rotate the **jog dial** to select a character and press **Enter**.
4. Repeat steps 2 and 3 to enter all of the characters.
5. When finished entering the characters, press **Enter** to save the entered characters.

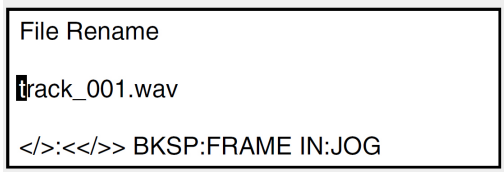

To return to the previous screen without saving the changes, press **Back**.

If a space is entered at the start or end of the file name or folder name, the space is deleted when the file name or folder name is saved.

### Deleting files and folders

1. Select **Delete** in the folder list menu, and press **Enter**.
2. Select **OK** by pressing **Enter** to delete the file when "Delete?" is displayed.

To cancel the file deletion and return to the file list menu, select "Cancel" and press **Enter**.

### Copying files and folders

1. Select **Copy** in the folder list menu, and press **Enter**. A media list for selecting the copy destination is displayed.
2. Rotate the **jog dial** to select the copy destination media, and press **Enter**. The folder list is displayed.
3. Rotate the **jog dial** to select **Copy Here?** in the copy destination folder level, and press **Enter** to start the copy process. During copying, "Executing ... zzz%" (z: progress status) is displayed. When the copying is complete, "Completed" is displayed.

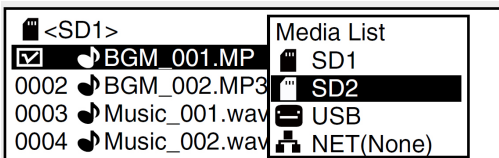

To cancel copying, select **Cancel** and press **Enter**.

Copying cannot be performed in the following situations:

- When the media is write-prohibited
- When there is not enough free space on the media
- When there is same file name / folder name

### Moving files

1. Select **Move** in the folder list menu, and press **Enter**. A media list for selecting the move destination is displayed.
2. Select the move destination media and press **Enter**. The folder list is displayed.
3. Rotate the **jog dial** to select **Move Here?** in the move destination folder level, and press **Enter** to start the move process. During moving, "Executing ... zzz%" (z: progress status) is displayed. When the moving is complete, "Completed" is displayed.  
Select "Cancel" and press **Enter** to cancel moving.

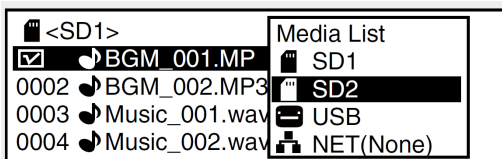

Files cannot be moved to other media in the following situations:

- When the media is write-prohibited
- When there is not enough free space on the media

### Creating folders

1. Rotate the **jog dial** to select **Make Folder**, and press **Enter**. The name change menu is displayed.
2. Enter the folder name and press **Enter** to save the changes.

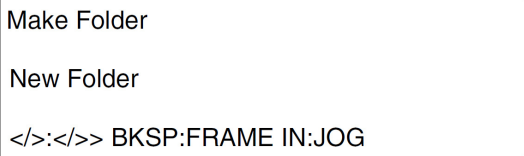

Press **Back** to return to the previous screen without saving the changes.

If a space is entered at the start or end of the folder name, the space is deleted when the folder name is saved.

### Deleting marks

1. Select **Delete Mark** in the folder list menu, and press **Enter**. "Delete Mark?" is displayed.
2. Select **OK** and press **Enter** to delete the marks.  
Select "Cancel" and press **Enter** to cancel the mark deletion and return to the file list.

### File information

Rotate the **jog dial** to select "Property", and press **Enter**. File information is displayed.

Press **Back** to return to the file list menu.

### Key lock

1. Hold down **Shift** and press **Lock** for more than 1 second. "Keys Restricted" is displayed. Operation buttons that can be used are Shift, Lock, On/Standby, Play, Pause, Rec, Mark +/-, Frame, ◀◀, ▶▶, |◀◀, ▶▶|. Press and hold **On/Standby** for more than 4 seconds to power off the unit.
2. Additionally, hold down **Shift** and press **Lock** for more than 1 second. "All Keys Locked" is displayed. Operation buttons that can be used are Shift, Lock, and On/Standby. Press and hold **On/Standby** for more than 4 seconds to power off the unit.
3. Additionally, hold down **Shift** and press **Lock** for more than 1 second. "All Keys Unlocked" is displayed. All keys are unlocked.

## Menu Operations

1. With the unit powered on, press the **Menu** button. The menu list is displayed.
2. Rotate the **jog dial** to select the desired menu and press **Enter**.  
**Note:** If an Admin password is set for System Setting, the password needs to be entered.
3. Rotate the **jog dial** to select the setting that requires change, and press **Enter**.
4. Rotate the **jog dial** to select the setting detail that requires change, and press **Enter**.  
 To continue to set other items, perform the operation in step 1-4 again. To return to the upper level menu from the menu item currently being set, press **Back**.  
 Press **Menu** to save the changed settings.  
 To cancel settings, press **Stop**. The display will show "Exit without Saving?". Rotate the **jog dial** to select **OK**, and press **Enter** to cancel the settings.

## Preset Settings

These settings are performed independently for each of the 3 presets (Preset 1, Preset 2, Preset 3). Select **Presets** from the Menu.

**Note:** You can restore the defaults for each of the presets using the Web Remote. Select the "Current Preset No" and press **Default** and then press **Save**. You can also restore defaults via the front panel **Menu > Preset Setting Preset1 > Default**.

**Preset Title:** Changes the preset name.

**Shift Mode:** Sets operation for the Shift button.

- **Momentary:** Switches to the shift function when holding down the Shift button along with a secondary function button.
- **Lock:** Switches to the shift function when the Shift button is pressed and released and a secondary function is pressed. In this case, the Shift button will illuminate.

**Power On:** Sets the operation when the unit is powered on.

- **Stop:** The unit stops when the power is switched on.
- **Resume Play:** Playback starts from the track that was played last.
- **Play First:** Playback starts from the first track in the folder that was played last.
- **Rec:** Starts recording in the folder of the currently selected media. Settings for the save folder may be configured in **System Setting > Rec Folder**.

**Dual Rec:** Sets the backup media for dual recording.

- **Off:** Turns dual recording off.
- **SD1:** Selects SD1 as the backup media.
- **SD2:** Selects SD2 as the backup media.
- **USB:** Selects USB as the backup media.

**Relay Rec:** Sets the media (secondary media) on which recording continues when relay recording is used.

- **Off:** Turns relay recording off.
- **SD1:** Selects SD1 as the secondary media.
- **SD2:** Selects SD2 as the secondary media.
- **USB:** Selects USB as the secondary media.

**Rec Level Type:** Sets the jog dial selection method for the recording level.

- **Master/Bal:** Adjusts the input level and balance of the left and right channels.
- **Separate L/R:** Adjusts the input level of the left and right channels individually.

**ALC:** Sets ALC (Auto Level Control).

- **Off (Preset 1/2):** Turns ALC off.
- **Mix:** Sets the same ALC for the left and right channels.
- **Separate (Preset 3):** Sets ALC for the left and right channels individually.

**One Touch Rec:** Sets the Record button operation.

- **Off (Preset 1/2):** Press the **REC** button once to pause recording; press it again to start recording.
- **On (Preset 3):** Press the **REC** button once to start recording.

**Audio Input:** Selects the audio input source for recording.

- **Bal:** Records the XLR analog input source.
- **UnBal:** Records the RCA analog input source.
- **AES / EBU:** Records the XLR digital input source.
- **Coaxial:** Records the RCA digital input source.
- **Dante:** Records the Dante digital input source.

**Rec Format:** Selects the audio recording format (MP3 or PCM)

- **Preset 1:** MP3-128 / MP3-64 / PCM-16
- **Preset 2:** MP3-320 / MP3-256 / MP3-192
- **Preset 3:** PCM-24

**Notes:**

- You can restore the defaults for each of the presets using the Web Remote. Select the "Current Preset No" and press **Default** and then press **Save**. You can also restore defaults via the front panel **Menu > Preset Setting Preset1 > Default**.
- Indicated bit rate values are those used to record as a stereo file.
- Select the bit rate for the MP3 format.
- Select the quantized bit number for the PCM format.
- MP3 cannot be selected when the Sample Rate is 96k.

**Rec Channel:** Select whether to record as a stereo file or a monoaural file.

- **Stereo:** Records as a stereo (2-channel) file.
- **Mono (L):** Records as a monoaural (left channel) file.
- **MonoMix:** Mixes as stereo (2-channel) and records as a -3 dB file.

**Sample Rate:** Selects the sampling frequency for recording.

**Note:** This is only enabled for recording from the analog input.

- **44.1k (Preset 1/2):** Records at 44.1 kHz.
- **48k:** Records at 48 kHz.
- **96k (Preset 3):** Records at 96 kHz. 96k cannot be selected when the "Rec Format" is MP3.
- **Ext (AES):** Records with an external clock (AES/EBU).

**Note:** Digital input sources record at the digital input sample rate.

**Pre-Record:** When recording is started from the recording paused status, recording starts retroactively for this set amount of time.

- **Off:** Turns pre-recording off.
- **1 sec / 2 sec / 3 sec / 4 sec / 5 sec**



**Auto Track:** Creates a new file for each recording time set and continues recording.

- **Off:** Record without creating a new file.
- **1 min / 5 min / 10 min / 15 min / 30 min / 1 hour / 2 hour / 6 hour / 8 hour / 12 hour / 24 hour**

**Note:** When the size of a recorded file reaches 2 GB, recording automatically switches to a new file and continues. There could be sound cutoffs for a short period of time between files depending on the capacity of a recorded file.

**Auto Mark:** If an input that is below the level set in “Silent Level” continues for longer than the time set in “Silent Time” marking information is written in the file.

- **Off:** Turns the auto mark function off.
- **On:** Turns the auto mark function on.

A maximum of 30 marks may be written to one file. Marking numbers are attached in numerical order starting from 1.

**Silent Skip:** If an input that is below the level set in “Silent Level” continues for longer than the time set in “Silent Time”, recording is paused. Recording is restarted when input above the set level is received again.

- **Off:** Turns the silent skip function off.
- **On:** Turns the silent skip function on. The S.S. icon is shown on the display (“Silent skip recording”).

If the recording is temporarily stopped because of the silent skip function, “S.S.” will flash on the display.

When “Silent Skip” is “On”, a maximum 0.5 second pre-recording is added before starting recording from the recording paused state.

**Silent Level:** Sets the silent level when “Auto Mark” or “Silent Skip” is set to on. (-60 dB, -54 dB, -38 dB, -20 dB)

**Silent Time:** Set the silence judgment time for silent skip recording (1 sec / 2 sec / 3 sec / 4 sec / 5 sec)

**Play Range:** Sets the track playback range.

- **All:** Plays back all of the tracks in all folders.
- **Folder:** Plays back all of the tracks in the selected folder.

**Note:** “All” is only enabled for SD card and USB device playback. If “All” is selected for NET playback, this operates with the “Folder” setting.

**Play Mode:** Sets the track playback mode.

- **Continuous:** Continuously plays the tracks within the selected folder or within all folders (according to the “Play Range” setting).
- **Single:** Plays back only 1 track.

**Random:** Sets random playback.

- **On:** Random order playback is performed.
- **Off:** Random order playback is not performed.

**Program:** Sets programmed playback.

- **On:** Plays back tracks in the set order (programmed playback).
- **Off:** Programmed playback is not performed.

**Finish Mode:** Sets the operation when playback is stopped.

- **Stop:** Playback stops.
- **Next:** When playback is stopped, the next track is cued.
- **Recue:** Playback stops and returns to the cue point.

**Repeat:** Sets repeat playback.

- **On:** Repeat playback is performed.
- **Off:** Repeat playback is not performed.

**Auto Cue:** Sets the auto cue function. The auto cue function temporarily stops playback at the point where playback restarts after skipping the silent portion at the beginning of a file.

- **Off:** Turns the auto cue function off.
- **-48 dB/-42 dB/-36 dB:** After the track has been selected, audio in the beginning of the track that is below the set volume level is skipped and temporarily stops playback.

**Note:** If the silent portion cannot be detected at the beginning of a file even after 20 seconds, playback will temporarily stop at the beginning of the file.

**Skip Back:** The track skips back at the set amount of time during playback or when paused, and plays back or remains paused.

- **0.5 sec / 2 sec / 60 sec:** Set the skip back time for a track that is currently being played back to 0.5 second intervals between 0.5 and 10 seconds, or 5 second intervals between 10 and 60 seconds.

**Search Mode:** Sets the search mode.

- **Normal:** Plays back audio at 2x normal speed when searching, but does not play back audio at faster playback speeds.
- **Silent:** Audio is not played back when searching.

**Auto Fade In:** Sets the fade in time at the start of playback.

- **Off:** Does not function.
- **0.5 sec / 1.0 sec / 3.0 sec:** The volume gradually increases for the set time.

**Auto Fade Out:** Sets the fade out time when playback is stopped.

- **Off:** Does not function.
- **0.5 sec / 1.0 sec / 3.0 sec:** The volume gradually decreases for the set time

**Start Delay:** Sets the playback start timing.

- **Off:** Does not function. Playback starts immediately.
- **100 ms / 200 ms / 300 ms:** Playback starts after the set time.

**End Of Message:** Sets how the “EOM” is illuminated in the display.

- **Off:** Does not function.
- **0 sec:** Flashes for 0.5 seconds when the track ends.
- **5 sec / 10 sec / 15 sec / 20 sec / 30 sec / 60 sec:** Flashes for the set amount of time before the track ends.

**Master Key:** Sets the master key for the pitch control function.

- **Off:** Disabled.
- **On:** Enabled.

**Time Display:** Sets how the playback and recording time are displayed.

- **HH:MM:SS:** Displayed in hours/minutes/seconds.
- **MMM:SS:FF:** Displayed in minutes/seconds/frames.

**File Sort:** Selects the sorting method for the file list order.

- **Name:** Sorts files in order of symbols, numbers, and alphabetical order.
- **Date:** Sorts files in date order.

**Note:** Sorting cannot be used when the media is “NET”. Files are sorted by folder.

**Dimmer:** Turns the Display Dimmer and LED Dimmer settings on/off.

- **Off:** Turns off the dimmer functions.
- **On:** Turns on the dimmer functions.

**Display Dimmer:** Sets the brightness of the display.

- **100%:** Normal brightness.
- **75%:** 75% of the normal brightness.
- **50%:** 50% of the normal brightness.
- **25%:** 25% of the normal brightness.
- **0%:** Off in the standby status, and 25% of the normal brightness during operation.

**LED Dimmer:** Sets the LED brightness.

- **100%:** Normal brightness.
- **75%:** 75% of the normal brightness.
- **50%:** 50% of the normal brightness.
- **25%:** 25% of the normal brightness.

**Screen Saver:** Sets the screen saver.

- **Off:** The screen saver does not function.
- **On:** The screen saver starts when there is no operation for 30 minutes.

## Renaming Presets

To rename a Preset title, follow the steps below to change the characters. A maximum of 32 characters may be used in the name.

### Entering Characters

1. Select the preset number to rename in the **Menu > User Preset Sel.**
2. Select **Preset Setting > Preset Title.**
3. Place the cursor in the position to insert characters using the << and >> buttons.
4. Rotate the **jog dial** to select a character and press **Enter.**
5. Repeat steps 3 and 4 to enter all of the characters.
6. When finished entering the characters, press **Enter** to save the entered characters.

### Deleting Characters

1. Place the cursor to the right of the character to delete using the << and >> buttons.
2. Press **Frame** to delete a character to the left of the cursor. By default, presets have a name that is eight characters long. To rename an existing name, delete the currently set characters first and then enter a new name.
3. To cancel without saving the entered characters, press the **Back** button before saving.

The following characters and symbols may be entered.

A B C D E F G H I J K L M N O P Q R S T U V W X Y Z a b c d e f g h i j k l m n o p q r s t u v w x  
y z (space)! # \$ % & ' ( ) + , - ; = @ [ ] ^ \_ ` ' « » { } ~ 0 1 2 3 4 5 6 7 8 9 j ¢ £ ¤ ¥ ¦ § ¨ © ª » ¬ ® ¯ ° ± ² ³ ´  
µ ¶ · ¸ ¹ º » ¼ ½ ¾ ¿ À Á Â Ã Ä Å Æ Ç È É Ê Ë Ì Í Î Ï Ñ Ò Ó Ô Õ Ö × Ø Ù Ú Û Ü Ý Þ ß à á â ã ä å  
æ ç è é ê ë ì í î ï ñ ò ó ô õ ö ÷ ø ù ú û ü ý þ ÿ

The characters above from j to ÿ are Latin alphabets.

## Recording

**Select the recording folder:** When “Current” is selected in **System Setting > Rec Folder**, the recorded file is stored in the selected folder. To store in a different folder, select a different folder. However, when “All” is selected in **Preset Setting > Play Range**, files are stored in the root folder. When “Fixed” is selected in **System Setting > Rec Folder**, a fixed folder is automatically created directly below the root folder. The default folder name is “DMH\_REC”.

**Note:** To record on an SD card, be sure to format it on the unit before recording. If the SD card is formatted on a computer or is used for recording without formatting it, this could result in sound cutoffs during recording.

The following results are displayed for media that cannot be recorded on.

- **No Format:** The media is unformatted has an unsupported formatting.
- **Write Inhibited:** The media is write-protected.
- **Media Full:** The recordable free space is less than 2MB.

**Note:** If the recordable space on the media falls below 2MB, recording will stop.

- **Track Full:** The number of files exceeds 2000.

**Recording monitor:** Hold **Shift** and press **Copy** to turn the recording monitor function on/off. When the recording monitor is turned on, the audio file as it is being recorded and stored on the media will be heard from the audio outputs. This is useful to check what the final quality of the recorded file sounds like.

**Note:** There will be a delay in the audio signal heard through the outputs when Rec Mon is turned on.

**Signal pass thru monitor:** When Signal Pass Thru is set to **On** in **System Setting**, the input signal selected in **Preset Setting > Audio Input** is sent to the outputs. Monitoring is performed regardless of whether the headphone setting is on or off. Signal pass thru monitoring will work during recording and when recording is paused.

## Recording

1. Press **Rec**. The unit switches to the recording paused state, and the Rec buttons flashes and the Pause button illuminates. When “On” is selected in **Preset Setting > One Touch Rec**, recording starts immediately when Rec is pressed.
2. Adjust the recording level and recording balance. Select “Variable” in **System Setting > Volume Input**. The input level may only be adjusted when **ALC** is set to “Off” and **Audio Input** is set to “Bal” or “UnBal” in **Preset Setting**.
3. Select **Preset Setting > Rec Level Type**.
  - **Master/Bal**: The input level may be adjusted using the jog dial. Also, hold down **Shift** and turn the **jog dial** to adjust the input level balance for the left and right channels.
  - **Separate L/R**: The input level of the left channel may be adjusted using the jog dial. Also, hold down **Shift** and turn the **jog dial** to adjust the input level balance for the right channel.
4. Press **Rec** to start recording.
  - **Pre-recording**: When the pre-recording time is set in **Preset Setting > Pre Record**, when recording is started, the recording starts retroactively for the set amount of time.
  - Press **Pause** to pause the recording. Press **Rec** again to resume recording on the same file.
  - When **Auto Mark** in the preset menu is set to **On**, a mark is added at the point where the recording is resumed from the paused status.
  - If the directory in which the recording is saved is the root directly, the total number of folders and files is limited to 512 by the FAT16 file system.
5. Press **Stop** to stop recording. Press **Play** to playback the recorded file.

**Dual recording:** The selected media and backup media may be recorded simultaneously.

1. Select the media to record.
2. Select the backup media. Dual recording is given priority when both Dual Rec and Relay Rec are selected in Preset Setting.
3. Start recording using the same operation as detailed in the **Recording** section. Recording starts simultaneously for the selected media and backup media.
  - The Backup Media file is stored in the folder set in **System Setting > Date Form**.
  - During recording, if the free space is fully used in the selected media first, recording to both the selected media and backup media stops.
  - During recording, if the free space is fully used in the backup media first, recording to the backup media stops but continues to the selected media.
  - When the selected media and backup media are the same media, dual recording is canceled, and normal recording starts.
  - When the record monitoring is on, normal recording starts only for the selected media.

**Relay recording:** Data is recorded to the first selected media, and when the remaining space on that media falls below 2MB, recording stops on that media and starts on the secondary media (media for continual recording).

1. Select the media for current recording.
2. Select the secondary media. Dual recording is given priority when both “Dual Rec” and “Relay Rec” are selected in **Preset Setting**.
3. Start recording using the same operation as detailed in the **Recording** section. Recording starts first on the selected media. The Relay media file is stored in the folder set in **System Setting > Date Form**.
  - When recording is complete on the selected media, recording starts on the secondary media.
  - When recording is complete on the secondary media, recording stops and relay recording is complete.
  - If the selected media and backup media are the same media, relay recording is canceled, and normal recording starts.

**Timer Recording:** Recording is performed for the set amount of time from the specified time. The recording start time specification (schedule type) may be set by day of week/time or time/date. A maximum of 30 recording timers may be set.

**Recording timer menu**

<b>Edit</b>	Enter or edit the timer information
<b>Insert</b>	Enter new timer information before the selected timer
<b>Clear</b>	Deletes the selected timer information
<b>All Clear</b>	Deletes all of the timer information
<b>Timer On</b>	Turns the selected timer on
<b>Timer Off</b>	Turns the selected timer off



### To set the timer recording start time and recording time settings

1. While the unit is stopped, press **Menu**. The menu list is displayed.
2. Rotate the **jog dial** to select **Rec Timer**, and press **Enter**. The recording timer list is displayed.
3. Rotate the **jog dial** to select **Empty**, and press **Enter**. The recording timer list menu is displayed.
4. Rotate the **jog dial** to select **Edit**, and press **Enter**. The type of recording schedule is displayed.
5. Rotate the **jog dial** to select the type of schedule, and press **Enter**.

The types of recording start schedules are:

- **Day of Week:** Specify the day and time.
- **Date Time:** Specify the date and time.

#### 6. Enter the Day of Week

- i. Rotate the **jog dial** to select the input position, and press **Enter**.
- ii. Rotate the **jog dial** to select the recording day, and press **Enter**. A check mark is added in front of the selected day.
- iii. After selecting the day, rotate the **jog dial** to select **Exit**, and press **Enter**. The recording start schedule is fixed. Repeat this process to select more than one day.

#### 7. Enter the Date Time

- i. Rotate the **jog dial** to select the input position, and press **Enter**.
- ii. Rotate the **jog dial** to select the “year”, and press **Enter**.
- iii. Rotate the **jog dial** to select the “month”, and press **Enter**.
- iv. Rotate the **jog dial** to select the “date”, and press **Enter**. The recording start schedule is set.

**Note:** The display order of the date (year/month/day) may be selected in **System Setting > Date Form**.

8. Rotate the **jog dial** to select the recording start time (hour/minute) or select “Every Hour” to have recording performed every hour, and press **Enter**.

**Note:** The current time display type (12-hour display/24-hour display) may be selected in **System Setting > Time Form**.

9. Rotate the **jog dial** to select the recording time (hours/minutes), and press **Enter**.

**Note:** The recording timer can set up to 99 hours and 59 minutes of recording time.

10. Enter characters to label the file. These will be included in the user area of the file name when the file is created. The file name of the recording includes the device name, the recording start time/date, and user area data.

### Turning timer recording on/off

1. In the recording timer list, rotate the **jog dial** to select the recording timer to turn on or off, and press **Enter**.
2. Rotate the **jog dial** to select Timer On or Timer Off, and press **Enter**.

### Editing timer recording information

In the recording timer list, rotate the **jog dial** to select the recording timer to edit, and press **Enter**. The recording timer list menu is displayed.

### Changing the start time or end time of a selected recording timer

In the recording timer list, rotate the **jog dial** to select **Edit**, and press **Enter**.

### Inserting a new recording timer in front of the selected recording timer

In the recording timer list, rotate the **jog dial** to select **Insert**, and press **Enter**. If the number of recording timers exceeds 30, the last timer data is overwritten.

### Deleting the selected recording timer

1. In the recording timer list, rotate the **jog dial** to select **Clear**, and press **Enter**.
2. Rotate the **jog dial** to select **OK**, and press **Enter**. The selected recording timer is deleted and the recording timer list is displayed.

### Deleting all recording timers

1. Rotate the **jog dial** to select **All Clear**, and press **Enter**.
2. Rotate the **jog dial** to select **OK**, and press **Enter**. All recording timers are deleted and the recording timer list is displayed.

## Operations During Recording

### Adding a file during recording

The manual track function divides tracks at the desired place during recording. Recording continues as a new file. Press **Divide** or **Rec** during recording. The file is cut at the point where the button is pressed, and recording continues in a new file. Files may also be divided at a specified amount of time.

**Note:** There could be sound cutoffs for a short period of time between files depending on the capacity of a recorded file.

If the size of a file being recorded reaches 2 GB, recording is continued by automatically switching to a new file. The manual track function is not available for two seconds after starting recording.

### Adding marks

During playback it is possible to search for marks and start playback from specific locations. By using this method, you can create specific search points within files without splitting files. Hold **Shift** and press **Mark** during recording to add a mark at the point where the button was pressed.

- A maximum of 30 marks may be written to one file.
- Marks may also be added automatically.

### Silent skip recording

When recording starts, silent sections during the recording may be detected and the recording paused during the silent sections.

- Set Silent Skip to **On** in **Preset Setting**.
- Set the silence finding level in **Preset Setting > Silent Level**.
- Set the silence finding time in **Preset Setting > Silent Time**.

If the recording input level is at a level lower than that selected in Silent Level and continues for a length of time that exceeds the time selected in Silent Time, recording to the media is paused and the S.S. indicator flashes. Subsequently, when a recording input level that exceeds the level selected in Silent Level is detected, recording starts again. If **Preset Setting > Pre Record** is set at this time, the pre-recording function operates. If **Preset Setting > Auto Mark** is "On", a mark is recorded when the recording starts.

## Playback

### Selecting from the Media List

1. Press **On/Standby**. When in the stopped state, hold down **Shift** and press **Media**.
2. While the unit is stopped, press **List**.
3. Select a file and press **Play**.

To pause playback, press **Pause** during playback. When **Play** is pressed again, playback is restarted. To stop playback, press **Stop**.

**Note:** If **Preset Setting > Finish Mode** is set to **Next**, the next track will be cued when playback is stopped. If **Preset Setting > Finish Mode** is set to **Recue**, the file will return to the cue point when playback is stopped.

**Note:** This unit can play back VBR (Variable Bit Rate) format files. The remaining time is displayed only as an estimated time when VBR (Variable Bit Rate) format files are played back.

## Operations During Playback

### Changing files

Rotate the **jog dial** during playback or while stopped. Rotating in a clockwise direction switches to the next file. Rotating in the counter-clockwise direction switches to the start of the current file, and then to previous files.

### Fast forward and fast rewind (Search)

- Press >> or << during playback or in the stopped state.
- Press << for fast rewind playback.
- Press >> for fast forward playback.

The search speed changes each time the button is pressed.

When “Silent” is selected in **Preset Setting > Search Mode**, sound is not output at speeds 2x and above.

When fast forward search is used to the end of the last file, or when fast rewind search is used to the start of the first file, the file pauses.

**Note:** Search cannot be performed on files that are recorded using VBR. If a VBR file is found during the search process, the search ends at the VBR file.

### Exiting fast forward and fast rewind (search)

Press **Play** or **Pause** during search. When Play is pressed, playback continues from the position where search was exited. When Pause is pressed, playback is paused at the position where search was exited.

### Jumping by frames (Frame jump)

1. Press **Frame** during playback, cue, or pause to switch to the Audible Pause state.
2. Press << or >>, or rotate the **jog dial**. Pressing << moves 1 frame in the reverse direction. Pressing >> moves 1 frame in the forward direction. When rotating the jog dial, one click moves one frame.

Press **Frame** to cancel frame search and return to the playback paused state.

**Note:** A frame equals 1/75 second.

### Rewind a specified amount of time and playback (Skip back)

During playback or pause, the track returns to a set amount of time from the playback position, and is then played back or paused from that position. This function can be controlled using Web Remote and Serial Remote. Set the time in **Preset Setting > Skip Back**.

#### Notes:

- Skip back cannot be operated from the front panel buttons.
- Files recorded in VBR cannot be skipped back.

### Playback pitch adjustment (Pitch control)

The playback speed may be adjusted within a range of -16% to +16%.

1. Press **Pitch** while holding down **Shift** during playback, cue, or when stopped. The pitch adjustment is enabled.
2. Press **Pitch +** or **Pitch -** while holding down **Shift**. The pitch changes by 0.1% each time the pitch button is pressed.

To cancel the pitch control, press **Pitch** again while holding down the **Shift** button.

When the playback speed is adjusted using the pitch control, the musical interval changes according to the playback speed.

When the master key function is on, the playback sound is played back without changing the musical interval even if the pitch is adjusted.

### Add marks (marking)

During playback or in the stopped state, hold down **Shift** and press **Mark**. A mark is added at the point. When a mark is added, "Mark z" (z: number of marks) is displayed.

Up to 30 marks can be added to a file.

**Note:** Marks are not supported for MP3 files that are not recorded by this unit. Marks are not supported when files are recorded in VBR.

### Searching for marks

During playback, cue or in the stopped state, hold down **Shift** and press **Mark +** or **Mark -**.

When **Mark +** is pressed, the track is forwarded to the next marked point and paused.

When **Mark -** is pressed, the system returns to the previous marked point and is paused.

Marks may only be searched within the current file.

### Random playback

Set **Preset Setting > Random** to **On**.

Press **Play**. Tracks are selected at random and playback starts.

### Program playback

A maximum of 99 tracks may be registered to a program. The program may be saved to the media and may be read later. See the **Program List** section for more details.

## Playback Timer

<b>Edit</b>	Enter or edit the timer information.
<b>Insert</b>	Enter new timer information before the selected timer
<b>Clear</b>	Deletes the selected timer information.
<b>All Clear</b>	Deletes all of the timer information.
<b>Timer On</b>	Turns the selected timer on.
<b>Timer Off</b>	Turns the selected timer off.

### Timer playback start time and playback file settings

1. While the unit is stopped, press **Menu**. The menu list is displayed.
2. Rotate the **jog dial** to select **Play Timer**, and press **Enter**. Displays the playback timer list.
3. Rotate the **jog dial** to select the file to use for timer playback, and press **Enter**. When the timer settings are complete, the set timer turns on.

### Turning timer playback on/off

1. In the playback timer list, rotate the **jog dial** to select the playback timer to turn on or off, and press **Enter**. Displays the playback timer list menu.
2. Rotate the **jog dial** to select Timer On or Timer Off, and press **Enter**. The playback timer list is displayed.

### Editing timer playback information

In the playback timer list, rotate the **jog dial** to select the playback timer to edit, and press **Enter**.

### Changing the start time or end time of a selected playback timer

Rotate the **jog dial** to select **Edit**, and press **Enter**.

### Inserting a new playback timer in front of the selected playback timer

Rotate the **jog dial** to select **Insert**, and press **Enter**. The last timer data is deleted.

### Deleting the selected playback timer

1. Rotate the **jog dial** to select **Clear**, and press **Enter**. "Clear?" is displayed.
2. Rotate the **jog dial** to select **OK**, and press **Enter**. The selected playback timer is deleted and the playback timer list is displayed.

### Deleting all playback timers

1. Rotate the **jog dial** to select **All Clear**, and press **Enter**. “All Clear?” is displayed.
2. Rotate the **jog dial** to select **OK**, and press **Enter**. All playback timers are deleted and the playback timer list is displayed.  
Press **Back** to cancel editing.

### Using timer playback

1. Set the timer playback information and turn the timer on.
2. Load a timer playback media to the current playback media. The timer playback priority for when the playback start time is reached may be set in **System Setting > Timer Priority**. However, the timer does not operate when the menu or file list, etc., is displayed or during recording.
3. When the unit is in standby, the power will turn on and start playback. If other operations are performed during timer playback, timer playback is cancelled.

### Program List

<b>Preview</b>	Previews the selected file
<b>Insert</b>	Enter a program or enter a new program in front of the selected program
<b>Remove</b>	Deletes the selected program
<b>Remove All</b>	Deletes all programs
<b>Load</b>	Reads the programs on the selected media
<b>Save</b>	Saves the programs on the selected media

### Creating a program

1. While the unit is stopped or in cue, press **Menu**. The menu list is displayed.
2. Rotate the **jog dial** to select **Program List**, and press **Enter**. The program list is displayed.
3. Rotate the **jog dial** to select **Empty**, and press **Enter**. The program list menu is displayed.
4. Rotate the **jog dial** to select **Insert**, and press **Enter**. The file list is displayed.
5. Rotate the **jog dial** to select the file to program, and press **Enter**.
6. Rotate the **jog dial** to select **Execute**, and press **Enter**. The program is entered.
7. Rotate the **jog dial** to select **Preview**, and press **Enter**. Preview playback of the selected file starts.
8. Press **Stop** to exit playback.

### Previewing programmed files

1. Place the cursor on the programmed file in the program list menu, and press **Enter**. The program list menu is displayed.
2. Rotate the **jog dial** to select **Preview**, and press **Enter**. Preview playback of the selected file starts.
3. Press **Stop** to end playback and return to the program list menu.

### Program playback

1. Set **Preset Setting > Program** to **On**.
2. Press **Play**. Tracks are played back in the created program order. If there are no program settings, tracks are played in normal playback.

Details for the program, play range, and random settings:

Program	Random	Play Range	Playback Content
On	Off	–	Program playback in the set track order.
On	On	–	Random playback within the program.
Off	Off	All	Plays back all tracks in all sub folders from the root folder in the order set in <b>Preset Setting &gt; File Sort</b> .
Off	On	All	Random playback within all files.
Off	Off	Folder	Plays back all tracks in the selected folder.
Off	On	Folder	Plays back all tracks in the selected folder in random order.



### Editing the program

1. Rotate the **jog dial** in the program list and place the cursor on the program to insert the program, and press **Enter**. The program list menu is displayed.
2. Rotate the **jog dial** to select **Insert**, and press **Enter**. The file list is displayed. When the number of programs exceeds 99, the last program is deleted.

### Deleting the selected program file

1. Rotate the **jog dial** in the program list and place the cursor on the program to delete, and press **Enter**. The program list menu is displayed.
2. Rotate the **jog dial** to select **Remove**, and press **Enter**.
3. Rotate the **jog dial** to select **OK**, and press **Enter**. The selected program file is deleted, and the program list is displayed.

### Deleting all program files

1. Press **Enter** on the program list. The program list menu is displayed.
2. Rotate the **jog dial** to select **Remove All**, and press **Enter**.
3. Rotate the **jog dial** to select **OK**, and press **Enter**. All program files are deleted, and the program list is displayed. Press **Back** to cancel editing.

### Saving program data

1. Press **Enter** on the program list. The program list menu is displayed.
2. Rotate the **jog dial** to select **Save**, and press **Enter**.
3. Rotate the **jog dial** to select **Save Here?** on the folder to save the file, and press **Enter**.
4. Rotate the **jog dial** to select **OK**, and press **Enter**.
5. Enter the file name of the program to be saved, and press **Enter**. The program is saved in the specified folder, and the program list is displayed.

### Reading the program from the selected media

1. Press **Enter** on the program list. The program list menu is displayed.
2. Rotate the **jog dial** to select **Load**, and press **Enter**.
3. Rotate the **jog dial** to select the file to read, and press **Enter**.
4. Rotate the **jog dial** to select **OK**, and press **Enter**. The program is displayed in the program list.

### Timer playback

- Playback is performed from the specified time for the set file.
- The playback start time specification (schedule type) may be set as the day of week and time or date and time.
- A maximum of 30 playback timers may be set.

## Hot Start

The unit may be controlled from other devices using Web Remote and serial commands. When a button is pressed, this function instantly starts playback of a pre-selected file. Hot start may be set for 20 tracks.

### Hot list menu

<b>Preview</b>	Previews the selected file.
<b>Auto Mapping</b>	20 tracks are automatically set to the hot list.
<b>Set</b>	Sets or resets the selected hot list.
<b>Remove</b>	Deletes the selected hot list.
<b>Remove All</b>	Deletes all hot lists.
<b>Load</b>	Reads the hot lists on the selected media.
<b>Save</b>	Saves the hot lists on the selected media.

### Registering tracks to a hot list

1. While device is stopped or in cue, press **Menu**.
2. Rotate the **jog dial** to select **Hot List**, and press **Enter**.
3. Rotate the **jog dial** to select **Empty**, and press **Enter**.
4. Rotate the **jog dial** to select **Set**, and press **Enter**.
5. Rotate the **jog dial** to select the file to select for hot start, and press **Enter**.
6. Rotate the **jog dial** to select **Execute**, and press **Enter**. Hot start is entered.

Hot List
01 BGM_002.MP3
02 Music_002.wav
03 <Empty>
04 <Empty>

### Previewing a hot start file

1. Press **Menu** and rotate the **jog dial** to select **Preview**, and press **Enter**. Preview playback of the selected file starts.
2. Press **Stop** to exit playback.

### Automatically registering tracks to a hot start list

Press **Menu** and rotate the **jog dial** to select **Auto Mapping**, and press **Enter**. A 20-track hot list is automatically registered. Files are registered in order from the first file based on the settings in **Preset Setting > Play Range**.

### Previewing files registered in the hot start list

1. Place the cursor on a hot start file in the Hot Start list, and press **Enter**. The hot list menu is displayed.
2. Rotate the **jog dial** to select **Preview**, and press **Enter**. Preview playback of the selected file starts.
3. Press **Stop** to end playback and return to the Hot Start list.

### Saving a hot list

1. Press **Menu** and rotate the **jog dial** to select **Hot List**, and press **Enter**.
2. Rotate the **jog dial** in the hot list menu to select **Save**, and press **Enter**.
3. Rotate the **jog dial** to select **Save Here?** for the media and folder in which you want to save the hot list, and press **Enter**. "Save?" is displayed.
4. Rotate the **jog dial** to select **OK**, and press **Enter**.
5. Enter the file name of the hot list to be saved, and press **Enter**.

### Loading a hot list

1. Press **Menu** and rotate the **jog dial** to select **Hot List**, and press **Enter**.
2. Press **Enter** on the hot list. The hot list menu is displayed.
3. Rotate the **jog dial** to select **Load**, and press **Enter**. The hot list is displayed.
4. Rotate the **jog dial** to select the hot list to read, and press **Enter**. "Load?" is displayed.
5. Rotate the **jog dial** to select **OK**, and press **Enter**.

### Removing a hot list file

1. Press **Menu**.
2. Rotate the **jog dial** to select **Hot List**, and press **Enter**.
3. Rotate the **jog dial** in the Hot List menu and place the cursor on the hot list that you want to delete, and press **Enter**. The hot list menu is displayed.
4. Rotate the **jog dial** to select **Remove**, and press **Enter**. "Remove" is displayed.
5. Rotate the **jog dial** to select **OK**, and press **Enter**. The selected hot list is deleted.

### Removing all hot list files

1. Press **Menu**.
2. Rotate the **jog dial** to select **Hot List**, and press **Enter**. The hot list menu is displayed.
3. Rotate the **jog dial** to select **Remove All**, and press **Enter**. "Remove All?" is displayed.

**Note:** Press **Back** to cancel editing.

4. Rotate the **jog dial** to select **OK**, and press **Enter**. All hot lists are deleted.

## Editing Files

### Combine

Combine the selected file with another file on the same media to create a new file.

1. Press **Combine** when the combine source files are cued or paused.
2. Rotate the **jog dial** to select the combine target file, and press **Enter**.

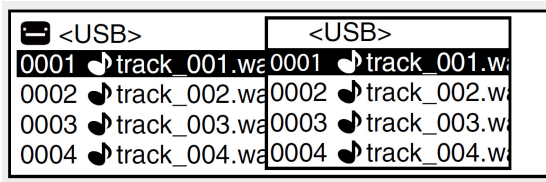

The file name of the file created by combining source files is created according to the same rules as recording. Files stored on other media cannot be combined. During combining, “Executing ... zzz%” (z: progress status) is displayed. When the combination is complete, “Completed” is displayed. Select “Cancel” and press **Enter** to cancel combining. The combined file is stored in the combination source folder. The files used in the combination remain unchanged.

- Combining cannot be performed in the following situations.
- When the selected media is write-prohibited
- When there is not enough free space on the selected media
- The maximum file size is 2 GB
- When the file format is a format other than WAV
- When the total number of files reaches 2000
- When the number of bits differs
- When the number of channels differs
- When the sampling rate differs

### Divide

The selected file can be split into 2 files at the current playback or recording position. The original file used in the division remains unchanged.

1. Press **Divide** during playback, cue, or pause. Displays “Divide?”.
2. Rotate the **jog dial** to select **OK**, and press **Enter**. Division starts.

During the division, “Executing ... zzz%” (z: progress status) is displayed. When the division is complete, “Completed” is displayed. Select **Cancel** and press **Enter** to cancel the division.

“\_A” is added to the previous file name for the first part of the divided file. (Example: When aaa.mp3 is divided -> aaa\_A.mp3) “\_B” is added to the previous file name for the second part of the divided file. (Example: When aaa.mp3 is divided -> aaa\_B.mp3)

Dividing cannot be performed in the following situations:

- When the selected media is write-prohibited
- At the start point or end point of a file
- When the file format is a format other than WAV or MP3
- When the number of files reaches 1999
- When there is not enough free space on the selected media
- When the file name after division already exists

## Copy

Copy the selected file to a folder on the same or different media.

1. Press **Copy** on the file that you want to copy, with the unit stopped, cued, or paused. A media list for selecting the copy destination is displayed.
2. Rotate the **jog dial** to select the copy destination media, and press **Enter**. The folder list is displayed.
3. Rotate the **jog dial** to select **Copy Here?** in the copy destination folder level, and press **Enter**. Copying begins.  
During copying, “Executing ... zzz%” (z: progress status) is displayed. When the copying is complete, “Completed” is displayed. Select **Cancel** and press **Enter** to cancel copying.

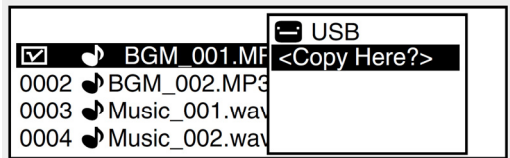
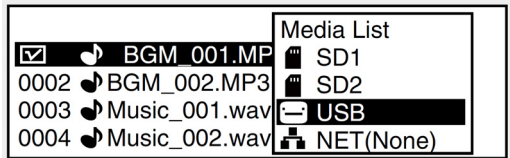

Copying cannot be performed in the following situations:

- When the media is write-prohibited
- When there is not enough free space on the media

## Move

Moves the selected file to a folder on the same or different media.

1. Press **Move** when the file that you want to move is stopped, cued, or paused. A media list for selecting the move destination is displayed.
2. Select the move destination media and press **Enter**. The folder list is displayed.
3. Rotate the **jog dial** to select **Move Here?** in the move destination folder level, and press **Enter**. Moving begins.

During moving, "Executing ... zzz%" (z: progress status) is displayed. When the moving is complete, "Completed" is displayed. Select **Cancel** and press **Enter** to cancel moving.

- Files cannot be moved to other media in the following situations.
- When the media is write-prohibited
- When there is not enough free space on the media

## Undo

Returns the edit operation performed immediately prior to the previous state.

Undo may be used on Combine, Divide, Copy, Move, and file and folder renaming operations.

1. Press **Undo** directly after making an edit. Displays "Undo?".
2. Rotate the **jog dial** to select **OK**, and press **Enter**. When the operation is finished, "Completed" is displayed.

**Note:** When the edit is cancelled using Undo, the file cannot be returned to its previous state.

## Connecting to a Network

When connected to a network that has a DHCP function, settings for the DN-900R such as the IP address are configured automatically. When connected to a network that does not have a DHCP function, you need to configure settings such as the IP address and DNS server in the **System Setting** menu.

**Note:** When configuring the network settings manually, contact your network administrator for the necessary setting details.

Required equipment:

- **Broadband Internet connection** (only required if connecting to an NTP time server)
- **Router:** We recommend using a router equipped with a built-in DHCP server and a built-in 100BASE-TX switch. When connecting multiple devices, we recommend a switching hub with a speed of 100 Mbps or greater.
- **Ethernet cable (CAT-5 or greater recommended):** Use only a shielded STP or ScTP LAN cable.

If you are using an Internet service on which network settings are made manually or with no DHCP function, adjust the settings directly from the Network Setup menu. When adjusting network settings manually, confirm the settings with your network administrator.

Do not connect the Ethernet cable from DN-900R directly to the LAN port/Ethernet connector on your computer. When connecting to a network that has no DHCP function, manually adjust the settings in the **System Setting** menu.

### To manually set up a static network connection (no DHCP)

1. Connect a shielded-type Ethernet cable. If a flat-type cable or unshielded-type cable is used, other devices could be affected by noise.
2. Power on DN-900R.
3. Press **Menu**. The menu list is displayed.
4. Rotate the **jog dial** to select **System Setting**, and press **Enter**.
5. Set the IP Address to **Static**. The currently set IP Address is displayed.
6. Specify the appropriate IP address, turning the jog dial and using the **Search+** and **Search-** to move the cursor. Press **Frame** to delete the previously entered number. Press **Back** to cancel the settings.
7. Press **Enter** when finished entering the numbers. The screen returns to the **System Setting** menu.

In the same way, enter the “Subnet Mask”, “Gateway” and “DNS Server” addresses. When the network settings are adjusted, press the **Menu** button. The unit will restart automatically after the network settings are changed.

## Dante Connection

DN-900R can be used to connect to dedicated Dante networks, often used for recording studios, live sound, and professional audio installations.

The Dante Controller software available from [audinate.com](http://audinate.com) enables you to route audio and configure devices on a Dante network.

A complete list of Dante Controller features is available at:  
[audinate.com/products/software/dante-controller](http://audinate.com/products/software/dante-controller).

**Note:** If the “Identify Device” feature  is activated in Dante Controller, the DN-900R will display the message “Dante Locate”.

The menu **Utility > Dante Status** shows the following:

- Device name
- IP/Mask
- MAC Address
- Streaming Status

The menu **System Setting > Dante Reset** can be used to reset the Dante device back to the factory defaults.



## Web Remote

You can control and configure settings for the DN-900R through your computer's web browser with the Web Remote application.

To connect to the DN-900R via the Web Remote, launch your web browser and type the IP address of the DN-900R (found in **Menu > Utility > Network Status**) into the address bar.

## Password

The screenshot displays the Web Remote interface for the DENON DN-900R. At the top, the header includes the DENON logo and 'DN-900R' on the left, the date and time '01/26/2019 09:24PM' in the center, and 'DN-900R' on the right. The main area is a dark gray background with a central login form. The form has two sections: 'Please select user name' with a dropdown menu showing 'Admin', and 'Please enter password' with a text input field and a 'GO' button.

1. Launch the Web Remote application and enter the password in the password screen to proceed to the Web Remote. The password screen is displayed if a password is set in the preset menu ("Admin Passwd"). If a password is not set in the preset menu, the screen will proceed directly to the control screen.
  - Alphabetic characters (upper and lower case), numbers, and symbols may be used in the password.
  - The password shall be between 6 to 12 characters in length.
2. Select the user name and enter the password in the "Password" text box.
3. Click **Go**.

## Main Screen



The Main screen is the first screen displayed when the Web Remote is launched.

This screen consists of:

1. **Model Name:** Displays the connected device name.
2. **Date/Time Information Display:** Displays the month/day/year and time originating from the device.
3. **Operation:** Shows the Control and Hot Start software options.
4. **Settings Screen:** Shows the software options for Preset Setting, Archive Setting, Rec Timer, Play Timer, Program, and System Setting.
5. **Others:** Shows the software option for the Utility menu.

### User IDs and Operating Permissions

There are three types of user IDs, and the operating permissions differ depending on the ID.

Passwords are set for each of the user IDs in DN-900R's **System Setting**.

User ID	Admin	Operator	Observer
<b>Password</b>	Admin Passwd	Operator Passwd	Observer Passwd
<b>View status and settings</b>	Yes	Yes	Yes
<b>Control operations</b>	Yes	Yes	No
<b>Hot start operations</b>	Yes	Yes	No
<b>Preset setting operations</b>	Yes	Yes	No
<b>Archive setting operations</b>	Yes	Yes	No
<b>Record timer operations</b>	Yes	Yes	No
<b>Play timer operations</b>	Yes	Yes	No
<b>Program operations</b>	Yes	Yes	No
<b>Utility operations</b>	Yes	Yes	No
<b>System setting operations</b>	Yes	No	No
<b>Login user list</b>	Yes	No	No

## Control Screen

The screenshot shows the DENON DN-900R Control Screen interface. At the top, it displays 'DENON PROFESSIONAL DN-900R', the date and time '01/26/2019 09:27PM', and 'DN-900R'. Below this are three tabs: 'OPERATION', 'SETTINGS', and 'OTHERS'. The main 'CONTROL' section is divided into several functional areas:

- Playback Controls:** Includes 'Elapsed Time' display, 'M.TRACK', and various transport controls (stop, play/pause, previous, next, first, last, repeat, shuffle). A red record button is also present.
- Rec Setting:** Features 'Rec Level - Master' and 'Rec Level - Balance' sliders, both set to 0dB, and a 'REC MON' button.
- Track List:** A table showing the current track list with columns for '#', 'Track', 'Size(KB)', and 'Path'. A search bar and a 'Media' dropdown are also visible.
- File Upload:** A section with a file input field, 'BROWSE', and 'UPLOAD' buttons.
- Play Setting:** Includes a 'Pitch' control with a slider and buttons for 'PITCH' and 'M.KEY'.
- Panel Lock:** A 'LOCK' button at the bottom left.

Numbered callouts (1-13) point to specific elements: 1 (Track List header), 2 (Rec Level sliders), 3 (File Upload upload button), 4 (BACK button), 5 (ENTER FOLDER button), 6 (Search bar), 7 (RENAME button), 8 (DELETE button), 9 (Elapsed Time display), 10 (Transport controls), 11 (File Upload browse button), and 12 (Pitch control).

#	Track	Size(KB)	Path
0001	♪01012019000959_DN-90	6482 /	
0002	♪01012019003431_DN-90	40369 /	
0003	♪01012019005216_DN-90	4345 /	
0004	♪01012019005444_DN-90	8141 /	
0005	♪01012019010130_DN-90	83 /	
0006	♪01012019184039_DN-90	150 /	
0007	♪01012019184154_DN-90	1737 /	
0008	♪05162019165757_DN-90	400 /	

In the Control screen, the current track list is displayed (Maximum number of files: 2000).

1. **Track List:** The DN-900R play list. The file name and size of MP3 and WAV data is displayed.
2. **Record Level and Record Balance:** Control the recording level and balance.
3. **Download Button:** Downloads the selected file to the computer.
4. **Back Button:** Press to cancel the edited settings.
5. **Enter Button:** Press to confirm the edited settings.
6. **Load Button:** The file selected in the track list is loaded in the DN-900R.
7. **Rename:** Rename the selected track in the list.
8. **Delete:** Delete the selected track from the list.
9. **Time and Operating Status Display:** Information about time, track number, operating status and the volume level meter are displayed. Over (OV) is indicated when it reaches -1 dB.
10. **Transport Controls**
11. **File Upload:** Load a file into the unit.
12. **Pitch:** Adjusts the pitch for the track playback.
13. **Panel Lock Button:** All buttons are locked other than Power, Lock, and Shift.

## Program Screen

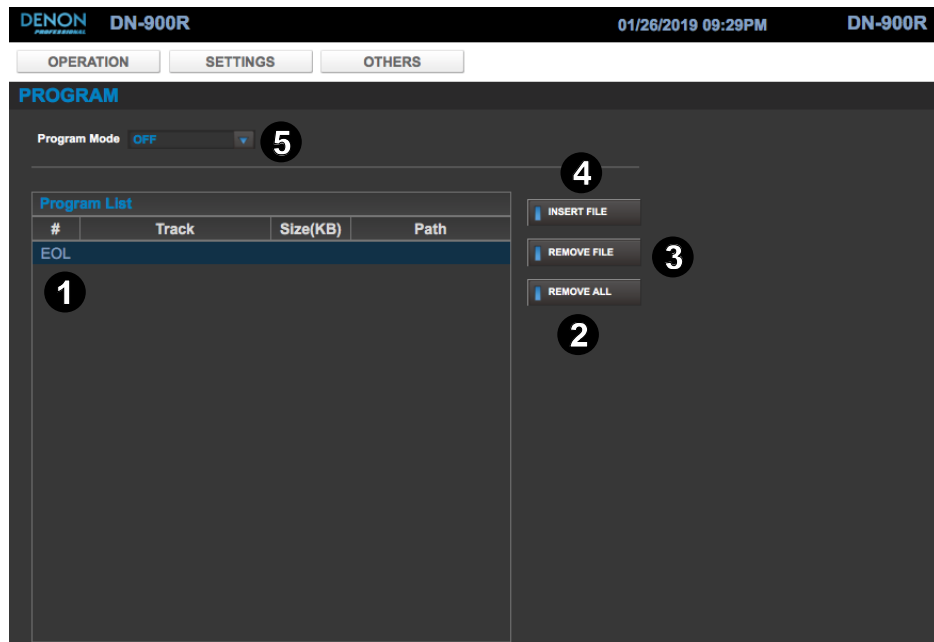

Configure the program (List) settings (Maximum number of program files: 99)

- Changes can only be made when the unit is stopped.
  - Files can be deleted and added to the program list.
  - Press the **Insert File** button to display the File List screen and select tracks to insert.
  - The files selected in Insert File are inserted one line above the selected line. To insert a file last, select the EOL line.
1. **Program Playback:** Displays the track list to be played.
  2. **Remove All Button:** Removes all files in program.
  3. **Remove File Button:** Deletes the selected line.
  4. **Insert File Button:** Switches to the file list. Files selected in the file list are inserted above the line selected in the program playback track list.
  5. **Program Mode:** Turns Program mode on or off.

## File List Screen

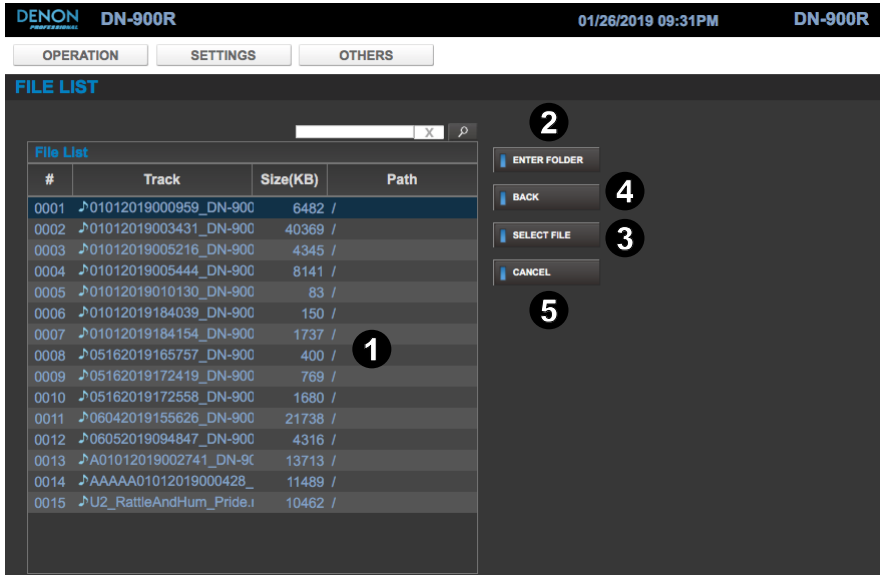

Press the **Mapping** button in the Hot Start screen or press the **Insert File** button in the Program screen to display the DN-900R file list and select files.

1. **File List:** Displays the list of files to be played.
2. **Enter Folder Button:** Enters the selected folder in the list.
3. **Select File Button:** The selected file is added to the program playback track list in the program screen or the Hot Start list in the Hot Start screen.
4. **Back:** Exits out of the current folder.
5. **Cancel:** Stops the current operation.

## Hot Start

DENON PROFESSIONAL DN-900R 01/26/2019 09:32PM DN-900R

OPERATION SETTINGS OTHERS

### HOT START

Track Display: Elapsed Time

Volume: -99dB

Hot Start Buttons: 1, 2, 3, 4, 5, 11, 12, 13, 14, 15, 6, 7, 8, 9, 10, 16, 17, 18, 19, 20

#	Track	Size(KB)	Path
0001	♪01012019000959_DN-9C	6482 /	
0002	♪01012019003431_DN-9C	40369 /	
0003	♪01012019005216_DN-9C	4345 /	
0004	♪01012019005444_DN-9C	8141 /	
0005	♪01012019010130_DN-9C	83 /	
0006	♪01012019184039_DN-9C	150 /	
0007	♪01012019184154_DN-9C	1737 /	
0008	♪05162019165757_DN-9C	400 /	
0009	♪05162019172419_DN-9C	769 /	

Control Buttons: AUTO MAPPING, MAPPING, REMOVE, REMOVE All

1. **Track Display:** Shows the track time and level for the playing track.
2. **Hot Start Buttons:** Press these buttons to start playback of an assigned track.
3. **Hot Start Track List:** Shows the list of tracks, file size, folder path, and assigned Hot Start number.
4. **Remove Button:** Cancels assignment of the selected Hot Start number.
5. **Remove All:** Cancels assignment of all Hot Start tracks.
6. **Mapping Button:** Individually assigns a file to the number selected in the Hot Start list. Press this button to display the file list and select a file you want to assign to Hot Start.
7. **Auto Mapping Button:** Automatically assigns up to 20 files to Hot Start from the top of the current file list.



## System Setting Screen

DENON DN-900R 01/26/2019 09:23PM DN-900R

OPERATION SETTINGS OTHERS

### SYSTEM SETTING

SAVE CANCEL DEFAULT

**GENERAL SETTINGS** 4

Play Timer Priority **Off** 1 2 3

**RECORD SETTINGS** 5

Rec Folder **Current** Rec Folder Name **DMH\_REC**

Signal Pass Thru **On** File Name Form **UA\_DT\_MN**

User Area Mode **Off** User Area

**PLAYBACK SETTINGS** 6

Mono Play **Off** Output Rate **Auto**

**AUDIO I/O SETTINGS** 7

Line/Mic Lch **Line** Line/Mic Rch **Line** Phantom Lch **Off**

Phantom Rch **Off** Mic In Sens Lch **40dBu** Mic In Sens Rch **40dBu**

Volume Input **Variable** Ref (XLR/RCA) **+24dBu/+10dBV** Input Trim Lch **0.0dB**

Input Trim Rch **0.0dB** Output Trim Lch **0.0dB** Output Trim Rch **0.0dB**

**DISPLAY SETTINGS** 8

Time Form **12H** Date Form **MDY** Display Contrast **5**

**REMOTE SETTINGS** 9

Serial Bit Rate **9600**

1. **Save:** Press to save the changes made in the System menu.
2. **Cancel:** Press to discard the changes made in the System menu.
3. **Default:** Press to reset the System menu settings to defaults.
4. **General Settings:** Sets the Play Timer Priority.
5. **Record Settings:** Adjusts settings for folder name, recording folder location, and user area mode.
6. **Playback Settings:** Adjusts settings for mono playback and output rate.
7. **Audio I/O Settings:** Adjusts input volume, input trim, phantom power, and output trim.
8. **Display Settings:** Adjusts the time format, date format, and display contrast.
9. **Remote Settings:** Adjusts the serial bit rate.

**10 NETWORK SETTINGS**

Machine Name  Network Standby

IP Mode  IP Address  Subnet Mask

MAC Address  Gateway  DNS Server

IP Control Port  IP Control Auth

NTP Mode  NTP Server  NTP Cycle H  :M

Syslog Mode  Syslog Server

**11 DANTE SETTINGS**

Device Name  IP Address  MAC Address

Sample Rate  Status  Dante Reset

**12 TIME ZONE SETTINGS**

Time Zone  H  :M

Daylight Saving  DST Offset H  :M

Start Date M  /D  H  M  AM

End Date M  /D  H  :M  AM

**13 ADMINISTRATION SETTINGS**

Admin Password  Retype

Operator Password  Retype

Observer Password  Retype

ProdMgr Detectable  ProdMgr Ctrl  Auto Reboot

10. Network Settings
11. Dante Settings
12. Time Zone Settings
13. Administration Settings

## Utility Screen

DENON PROFESSIONAL DN-900R 01/26/2019 09:34PM DN-900R

OPERATION SETTINGS OTHERS

UTILITY

- 1 Software Version A-1.03
- 2 Software Update  BROWSE UPDATE
- 3 Preset File  BROWSE DOWNLOAD UPLOAD
- 4 Date M 01 /D 26 /Y 2019  
Time H 09 :M 33 PM ADJUST
- 5 Log File DOWNLOAD
- 6 Format Media FORMAT
- 7 Speed Check CHECK
- 8 Operator Log-off DISCONNECT  
Observer Log-off DISCONNECT
- 9 Power Control STANDBY

1. **Software Version:** Displays the current software version for DN-900R.
2. **Software Update:** Select the downloaded firmware update file to send to DN-900R.
3. **Preset File:** Select a preset file to upload or download to DN-900R.
4. **Date/Time:** Set the date and time for the unit.
5. **Log File:** Download the recording log file.
6. **Format Media:** Format the SD card.
7. **Speed Check:** Checks the recording capabilities of the SD card.
8. **Log-off:** Disconnects the Operator or Observer from the Web interface.
9. **Power Control:** Turn this option on to put the unit in Standby mode.

## Preset Setting Screen

DENON DN-900R
01/26/2019 09:33PM
DN-900R

OPERATION
SETTINGS
OTHERS

### PRESET SETTING

**1** CURRENT PRESET NO.

Preset No. 1: Preset1

**2** GENERAL SETTINGS

Preset Title Preset1    Shift Mode Momentary    Power On Stop

**3** RECORD SETTINGS

Dual Rec <span style="border: 1px solid #ccc; padding: 2px;">Off</span>	Relay Rec <span style="border: 1px solid #ccc; padding: 2px;">Off</span>	Rec Level Type <span style="border: 1px solid #ccc; padding: 2px;">Master/Bal</span>
ALC <span style="border: 1px solid #ccc; padding: 2px;">Off</span>	One Touch Rec <span style="border: 1px solid #ccc; padding: 2px;">Off</span>	Audio Input <span style="border: 1px solid #ccc; padding: 2px;">Bal</span>
Rec Format <span style="border: 1px solid #ccc; padding: 2px;">MP3-12B</span>	Rec Channel <span style="border: 1px solid #ccc; padding: 2px;">Stereo</span>	Sample Rate <span style="border: 1px solid #ccc; padding: 2px;">44.1k</span>
Pre Record <span style="border: 1px solid #ccc; padding: 2px;">Off</span>	Auto Track <span style="border: 1px solid #ccc; padding: 2px;">Off</span>	Auto Mark <span style="border: 1px solid #ccc; padding: 2px;">Off</span>
Silent Skip <span style="border: 1px solid #ccc; padding: 2px;">Off</span>	Silent Level <span style="border: 1px solid #ccc; padding: 2px;">-38dB</span>	Silent Time <span style="border: 1px solid #ccc; padding: 2px;">3sec</span>

**4** PLAYBACK SETTINGS

Play Range <span style="border: 1px solid #ccc; padding: 2px;">Folder</span>	Play Mode <span style="border: 1px solid #ccc; padding: 2px;">Continuous</span>	Random <span style="border: 1px solid #ccc; padding: 2px;">Off</span>
Program <span style="border: 1px solid #ccc; padding: 2px;">Off</span>	Finish Mode <span style="border: 1px solid #ccc; padding: 2px;">Next</span>	Repeat <span style="border: 1px solid #ccc; padding: 2px;">Off</span>
Auto Cue <span style="border: 1px solid #ccc; padding: 2px;">Off</span>	Skip Back <span style="border: 1px solid #ccc; padding: 2px;">5.0sec</span>	Search Mode <span style="border: 1px solid #ccc; padding: 2px;">Normal</span>
Auto Fade In <span style="border: 1px solid #ccc; padding: 2px;">Off</span>	Auto Fade Out <span style="border: 1px solid #ccc; padding: 2px;">Off</span>	Start Delay <span style="border: 1px solid #ccc; padding: 2px;">Off</span>
End Of Message <span style="border: 1px solid #ccc; padding: 2px;">Off</span>	Master Key <span style="border: 1px solid #ccc; padding: 2px;">Off</span>	

**5** DISPLAY SETTINGS

Time Display <span style="border: 1px solid #ccc; padding: 2px;">HH:MM:SS</span>	File Sort <span style="border: 1px solid #ccc; padding: 2px;">Name</span>	Dimmer <span style="border: 1px solid #ccc; padding: 2px;">Off</span>
Display Dimmer <span style="border: 1px solid #ccc; padding: 2px;">100%</span>	LED Dimmer <span style="border: 1px solid #ccc; padding: 2px;">100%</span>	Screen Saver <span style="border: 1px solid #ccc; padding: 2px;">Off</span>

1. **Preset Number:** Selects the preset file to use.
2. **General Settings:** Shows the Preset name, Shift function, and power-on function.
3. **Record Setting:** Select the various settings for recording.
4. **Playback Settings:** Select the various settings for playback.
5. **Display Settings:** Select the settings for the time, dimmer, and screensaver.

## Play Timer

DENON DN-900R 01/26/2019 09:35PM DN-900R

OPERATION SETTINGS OTHERS

### PLAY TIMER

#	Title	Setting
01	Play Timer 01	<empty>
02	Play Timer 02	<empty>
03	Play Timer 03	<empty>
04	Play Timer 04	<empty>
05	Play Timer 05	<empty>
06	Play Timer 06	<empty>
07	Play Timer 07	<empty>
08	Play Timer 08	<empty>
09	Play Timer 09	<empty>

EDIT  
INSERT  
CLEAR  
ALL CLEAR

#### PLAY TIMER SETTINGS

Timer Mode: Off

Schedule Type: DayOfWeek

Date:  Sun  Mon  Tue  Wed  Thu  Fri  Sat

Time: H EveryH :M 00

File Name:

1. **File List:** Displays the list of titles to be played.
2. **Edit:** Enter or edit the timer information.
3. **Insert:** Enter new timer information before the selected timer location.
4. **Clear:** Deletes the selected timer information.
5. **All Clear:** Deletes all of the timer information.
6. **Play Timer Settings:** Edit the playback timer mode settings, scheduling date, time, and file name.

## Record Timer

DENON DN-900R 01/26/2019 09:35PM DN-900R

OPERATION SETTINGS OTHERS

### REC TIMER

#	Title	Setting
01	Record Timer 01	<empty>
02	Record Timer 02	<empty>
03	Record Timer 03	<empty>
04	Record Timer 04	<empty>
05	Record Timer 05	<empty>
06	Record Timer 06	<empty>
07	Record Timer 07	<empty>
08	Record Timer 08	<empty>
09	Record Timer 09	<empty>

EDIT  
INSERT  
CLEAR  
ALL CLEAR

#### REC TIMER SETTINGS

Timer Mode: Off  
Schedule Type: DayOfWeek  
Date: Sun Mon Tue Wed Thu Fri Sat ALL  
Time: H EveryH :M 00  
Duration: H 00 :M 00  
User Area Mode: Off  
User Area: \_\_\_\_\_  
SAVE

- File List:** Displays the list of titles scheduled to be recorded.
- Edit:** Enter or edit the timer information.
- Insert:** Enter new timer information before the selected timer location.
- Clear:** Deletes the selected timer information.
- All Clear:** Deletes all of the timer information.
- Record Timer Settings:** Edit the record time settings for timer mode, schedule type, date, time, duration, and user specified characters added to the filename.

## Archive Settings

DENON DN-900R
01/26/2019 09:34PM
DN-900R

OPERATION SETTINGS OTHERS

### ARCHIVE SETTING

SAVE CANCEL DEFAULT CONNECTION TEST

**MODE SETTINGS**

Archive Mode: Off

**SCHEDULE SETTINGS**

Schedule Type: DayOfWeek

Date:  Sun  Mon  Tue  Wed  Thu  Fri  Sat ALL

Time: H 12 :M 00 AM

**FTP SERVER SETTINGS**

Server:

User ID:

Password:

Folder:  SELECT FOLDER

**OPTION SETTINGS**

Clear After Arc: Off

Auto Deletion: Off

SAVE CANCEL DEFAULT CONNECTION TEST

### Archive Mode

- **Off:** No archiving.
- **Auto:** Recorded files are automatically archived when recording is complete.
- **Timed:** Recorded files are archived according to a set schedule when recording is complete.

### Archive Schedule

Sets the schedule to archive. This option is only displayed when “Timed” is selected as the Archive mode.

- **Day of Week:** Sets the day and time (hours, minutes).
- **Date/Time:** Sets the date and time (year, month, date, hours, minutes).

### Server

Sets the IP address and credentials of the FTP server.

- **IP Address:** 0.0.0.0 to 255.255.255.255 (default setting is 0.0.0.0).
- **User ID:** Input the user ID for the computer/server which will contain the archived files.
- **Password:** Input the password for the user name.
- **Folder:** Select the folder to archive to the server.

### Notes:

- If the user is part of a domain then input the domain\user name.
- Alpha-numeric characters can be used along with most special characters.

### Clear After Arc.

Set to automatically delete the files after archiving is complete.

- **Off:** Files are not deleted after archiving is complete.
- **On:** Files are automatically deleted after archiving is complete.

### Auto Deletion

When in the stopped state, archived files are deleted in order from the oldest onwards when the free recording space on the media is less than the set time.

- **Off:** No files will be deleted.
- **24h:** Archived files are deleted when the recording free space is less than 24 hours.
- **12h:** Archived files are deleted when the recording free space is less than 12 hours.
- **6h:** Archived files are deleted when the recording free space is less than 6 hours.
- **3h:** Archived files are deleted when the recording free space is less than 3 hours.
- **1h:** Archived files are deleted when the recording free space is less than 1 hours.

### Connection Test

Performs a communication test with the FTP server.

### Default

Initializes the archive setting details back to defaults.



## Archive Files

This backup function sends recorded files from the currently selected media (SD or USB) to a FTP server.

1. While device is stopped, press **Menu**. The menu list is displayed.
2. Rotate the **jog dial** to select **Archive Setting**, and press **Enter**. The archive setting items are displayed.

**Note:** When **Clear After Arc** is on, the files on the selected media are deleted after being archived to the FTP server.

3. Rotate the **jog dial** to select the item that you want to change, and press **Enter**. When archiving is started, "Now Archiving..." is displayed. When archiving is complete, "Archive Completed" is displayed.

Archiving is not performed in the following conditions even if archive is set to "Auto" or "Timed":

- During playback
- When the record monitoring is operating during recording
- During dual recording
- During WAV recording with a 96 kHz sampling rate
- When the selected media is write-prohibited
- When the menu screen is being displayed

## Serial Remote Control Function

In the Serial Remote Control function, a host such as a computer is connected to the unit. By sending control commands from the host to the unit, the unit can be operated, and the status information of the unit can be checked both on the unit and host. There are 2 methods for connecting the host and unit, RS-232C control and IP Control.

**Note:** Visit the DN-900R product page at [denonpro.com](http://denonpro.com) to download the *Serial Protocol Guide* for more information.

### RS-232C control

You will be able to perform three control functions from the host by connecting an RS-232C straight cable to the RS-232C serial terminal (9-pin D-sub) connector. The three control functions are:

1. Controlling the DN-900R externally.
2. Sending the status information to the host when DN-900R receives a status request command from the host.
3. Automatically sending the status information to the host when there is a change to the DN-900R status.

### About Connections

- Transmission System: Asynchronous full duplex transmission
- Compatible connector: 9-pin D-sub (male)
- Communication speed: 9,600/38,400 bps selectable (System Setting: Serial Bit Rate)
- Data bit: 8 bit
- Parity: None
- Start bit: 1 bit
- Stop bit: 1 bit
- Flow control: None

### Pin arrangement

Pin number	Signal name
1	Ground
6	NC
2	TxD
7	RTS*
3	RxD
8	NC
4	NC
9	NC
5	S. Ground

\* 4V, 500mA power supply can be used for RTS.

## IP Control (Ethernet)

You will be able to perform the three control functions from the host by connecting an Ethernet cable to the Ethernet connector. (Connector type: RJ-45 (10BASE-T/100BASE-TX))

### Communication format

- Communication system: Full duplex
- Communication speed: 10 Mbps/100 Mbps
- Communication port: TCP port 23 (telnet)
- Communication data length: 135 bytes (maximum)

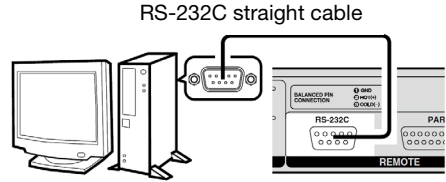

### Connecting the DN-900R and host directly

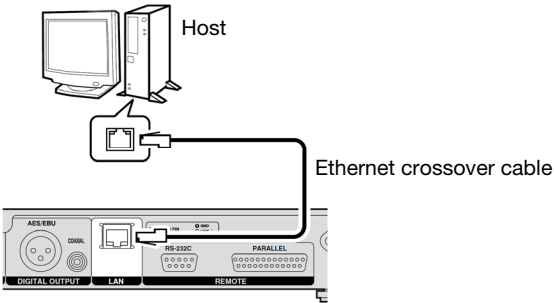

### Connecting DN-900R and host via a switch/router

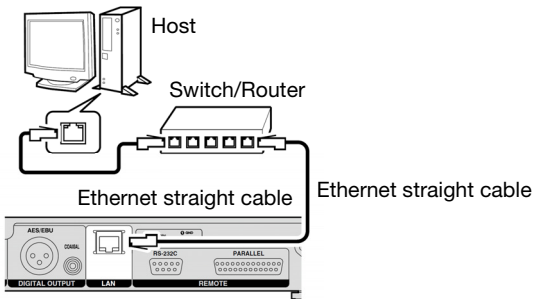

## Troubleshooting

Error message	Cause/Solution
No Media	Cannot detect media.
Unformat	The media is formatted in an unsupported format. Format the media on DN-900R or set the format to FAT16 or FAT32.
Media Full	The remaining space on the media is running low. Replace the media with a new one or delete files that are no longer required.
Track Full	The number of files on the selected media exceeds 2000. Recording cannot be performed if the number of files exceeds 2000. Replace the media with a new media or delete unneeded files.
Write Inhibited	The selected media is write-prohibited. Remove the write-protection from the media.
File Not Found	Target file does not exist. Check the file.
Track Not Found	The target track does not exist. Check the media.
Already Exists	A file with the same name already exists. <ul style="list-style-type: none"> <li>• Copy, Move, Divide: Check the folder.</li> <li>• Rename: Change the file name before entering the name.</li> </ul>
Err Media XX	Not supported on this unit. Replace the media.
VBR	This error message appears when a VBR file search is performed. Search cannot be performed on VBR files. When the selected track is VBR format, the estimated remaining time is displayed.
Not Allowed Not Available	This appears when an invalid operation is performed. The operation may be disabled due to other setting items such as the preset menu, etc. Check the details of the operation.
No Mark	There are no marks for the mark jump. Set marks.
Some files are skipped	There is a file with the same name in the copy or move location. Files with the same name cannot be copied or moved.
ALC	The Rec Level cannot be changed when the ALC settings are enabled. Turn the ALC settings off to change the Rec Level.
Registered	The file that have been added to a program, hot start, or timer playback list. Files registered to these lists cannot be edited.

<b>Error message</b>	<b>Cause/Solution</b>
No Backup Media (XXX)	Backup media cannot be detected.
Media Write Inhibited (XXX)	The backup media is write-prohibited. Remove the write-protection from the media.
Backup Media Full (XXX)	There is no free space on the backup media. Replace the media with a new media or delete unneeded files.
Dual Rec Canceled (W01)	The selected media is the same as the backup media set in the preset settings. Dual recording is canceled, and normal recording is performed.
Dual Rec Canceled (W02)	The record monitoring is on. Dual recording is canceled, and normal recording is performed.
No Secondary Media (XXX)	The secondary media cannot be detected.
Secondary Media Write Inhibited (XXX)	The secondary media is write-prohibited. Remove the write-protection from the media.
Secondary Media Full (XXX)	There is no free space on the secondary media. Replace the media with a new media or delete unneeded files.
Server Not Found	The server is not connected, or the server cannot be found.
Account Error	Cannot log in to the server.
Folder Not Found	Cannot find the archive destination folder.
Err Media XXX	Cannot obtain information from the selected media.
Server Media Full	The server capacity is full.
Err Network	An error has occurred while transferring the data.
Not Connected	Check if it is properly connected to DN-900R. If this message persists, replace the cable.
No Media	The media inserted in DN-900R has not been detected. Eject and insert the media again.

\* XXX: SD1, SD2, USB

## Appendix (English)

### Technical Specifications

<b>Inputs</b>	Mic/Line In (2 XLR connectors), Line In (2 RCA connectors), Digital In (1 AES/EBU, 1 S/PDIF), Dante Digital In (RJ-45 connector)
<b>Balanced Analog In L/R</b>	<b>Type:</b> XLR (1:GND, 2:Hot, 3:Cold) <b>Line setting input level:</b> +4 dBu <b>Maximum input level:</b> +24 dBu/+20 dBu/+18 dBu <b>Input impedance:</b> 20 k $\Omega$ <b>Mic setting input level:</b> -60 to 16 dBu <b>Input impedance:</b> 5 k $\Omega$ <b>EIN:</b> Less than -127 dBu (Rs = 150 $\Omega$ ) <b>CMRR:</b> <80 dB
<b>Unbalanced Analog In L/R</b>	<b>Type:</b> RCA terminal <b>Input level:</b> -10 dBV <b>Maximum input level:</b> +10 dBV/+6 dBV/4 dBV <b>Input impedance:</b> 10 k $\Omega$
<b>Unbalanced Digital In</b>	<b>Type:</b> RCA terminal <b>Input impedance:</b> 75 $\Omega$ <b>Standard input level:</b> 0.5 Vp-p <b>Format:</b> IEC-60958 (Coaxial)
<b>Balanced Digital In</b>	<b>Type:</b> XLR (1:GND, 2:Hot, 3:Cold) <b>Input impedance:</b> 110 $\Omega$ <b>Standard input level:</b> 3.5 Vp-p <b>Format:</b> IEC-60958 (AES/EBU)
<b>Dante Digital In</b>	<b>Type:</b> 100 Mbps Ethernet RJ-45 connector <b>Format:</b> 24 bit; 48, 44.1 kHz sampling rates, uncompressed
<b>Outputs</b>	Balanced Analog Out L/R (XLR), Unbalanced Out L/R (RCA), Balanced Digital Out (AES/EBU), Unbalanced Digital Out (S/PDIF), Headphone Output (1/4" / 6.35 mm), Dante Digital Out (RJ-45 connector)
<b>Balanced Analog Out L/R</b>	<b>Type:</b> XLR (1:GND, 2:Hot, 3:Cold) <b>Load impedance:</b> Over 600 $\Omega$ <b>Output level:</b> +4 dBu at 600 $\Omega$ load <b>Maximum output level:</b> +24 dBu/+20 dBu/+18 dBu
<b>Unbalanced Analog Out L/R</b>	<b>Type:</b> RCA terminal <b>Load impedance:</b> Over 10 k $\Omega$ <b>Output level:</b> -10 dBV <b>Maximum output level:</b> +10 dBV/+6 dBV/+4 dBV
<b>Balanced Digital Out</b>	<b>Type:</b> XLR (1:GND, 2:Hot, 3:Cold) <b>Output impedance:</b> 110 $\Omega$ <b>Standard output level:</b> 3.0 Vp-p <b>Format:</b> IEC-60958 (AES/EBU)
<b>Unbalanced Digital Out</b>	<b>Type:</b> RCA terminal <b>Output impedance:</b> 75 $\Omega$ <b>Standard output level:</b> 0.5 Vp-p <b>Format:</b> IEC-60958 (Coaxial)

<b>Dante Digital Out</b>	<b>Type:</b> 10/100 Ethernet RJ-45 connector <b>Format:</b> 24 bit, 48, 44.1 kHz sampling, uncompressed
<b>Dante Network Audio</b>	<b>Latency:</b> Less than 1 ms (excluding auxiliary signal paths) <b>Sample rate:</b> DN-900R uses SRC on its output to Dante to convert recorder sample rate to Dante Network sample rate. <b>Sample bit depth:</b> 24 bit
<b>Compatible Media</b>	SD/USB memory/USB HDD
<b>Headphone Out</b>	1/4" (6.35 mm) 20 mW/32 Ω
<b>Storage</b>	<b>Maximum storage capacity:</b> Up to 2 TB <b>Maximum file size:</b> 2 GB <b>Maximum number of files:</b> 2000 files (for 1 folder) <b>Maximum number of folders:</b> 1000 folders <b>Maximum number of folder hierarchies:</b> 8 (under the root directory)
<b>File System</b>	FAT16, FAT32, HFS+, exFAT
<b>File Format Specifications</b>	<b>Compatible media:</b> SD, SDHC, USB memory, USB HDD <b>Extension:</b> WAV, AIFF, AIF <b>Resolution:</b> 16 bit, 24 bit <b>Sampling frequency:</b> 44.1k, 48k, 96k
<b>Playable MP3 Format</b>	<b>Extension:</b> MP3 <b>Bit rate:</b> 32 - 320 kbps, VBR <b>Sampling frequency:</b> 44.1k, 48k
<b>Playable AAC Format</b>	<b>Extension:</b> M4A <b>Compression method:</b> AAC-LC <b>Bit rate:</b> 64 - 320 kbps, VBR <b>Sampling frequency:</b> 44.1k, 48k
<b>Number of Channels</b>	2 (stereo), 1 (mono)
<b>Audio Frequency Characteristics</b>	Line / Mic (-16 dBu) (+0.5 dB / -1 dB)
<b>S/N Ratio</b>	<89 dB (A-weighted)
<b>Total Harmonic Distortion</b>	Less than 0.01%
<b>Dynamic Range</b>	<106 dB (for 24 bit WAV playback)
<b>Channel Separation</b>	> -90 dB
<b>Variable Pitch Width</b>	-16% to +16%
<b>Variable Trim Adjustment Width</b>	+/-2.0 dB
<b>Power</b>	<b>Connection:</b> Standard IEC (switching power supply) <b>Input voltage:</b> 120V AC, 60 Hz (US and Canada models) 230V AC, 50/60 Hz (EU, UK, Asia/Pacific models) <b>Power consumption:</b> 30 W, 0.4 W (standby), 3.4W (Network standby)
<b>Environmental Conditions</b>	<b>Operating temperature:</b> 41 to 95 °F <b>Operating humidity:</b> 25–85%, non-condensing <b>Storage temperature:</b> -4 to 140 °F

<b>Dimensions</b> (width x depth x height)	16.92" x 9.48" x 1.68" / 430 x 241 x 43 mm
<b>Weight</b>	5.7 lbs. / 2.6 kg

Specifications are subject to change without notice.

## Trademarks & Licenses

Denon is a trademark of D&M Holdings Inc., registered in the U.S. and other countries. Denon Professional products are produced by inMusic Brands, Inc., Cumberland, RI 02864, USA. Dante® is a registered trademark of Audinate Pty Ltd. iOS is a registered trademark of Cisco in the U.S. and other countries and is used under license. Android is a registered trademark of Google Inc. SD and SDHC are registered trademarks of SD-3C, LLC. All other product names, company names, trademarks, or trade names are those of their respective owners.





**denonpro.com**