

DENON
PROFESSIONAL

Network SD/USB Recorder

DN-700R

Owner's Manual

IMPORTANT TO SAFETY

WARNING:

To reduce the risk of fire and electric shock, this apparatus should not be exposed to rain or moisture and objects filled with liquids, such as vases, should not be placed on this apparatus

CAUTION

1. Handle the power supply cord carefully

Do not damage or deform the power supply cord. If it is damaged or deformed, it may cause electric shock or malfunction when used. When removing from wall outlet, be sure to remove by holding the plug attachment and not by pulling the cord.

2. Do not open the rear cover

In order to prevent electric shock, do not open the top cover. If problems occur, contact your DENON DEALER.

3. Do not place anything inside

Do not place metal objects or spill liquid inside the system. Electric shock or malfunction may result.

Please, record and retain the Model name and serial number of your set shown on the rating label.

Model No. DN-700R

Serial No. _____



CAUTION
RISK OF ELECTRIC SHOCK
DO NOT OPEN



CAUTION:

TO REDUCE THE RISK OF ELECTRIC SHOCK, DO NOT REMOVE COVER (OR BACK). NO USER-SERVICEABLE PARTS INSIDE. REFER SERVICING TO QUALIFIED SERVICE PERSONNEL.



The lightning flash with arrowhead symbol, within an equilateral triangle, is intended to alert the user to the presence of uninsulated "dangerous voltage" within the product's enclosure that may be of sufficient magnitude to constitute a risk of electric shock to persons.



The exclamation point within an equilateral triangle is intended to alert the user to the presence of important operating and maintenance (servicing) instructions in the literature accompanying the appliance.

FCC INFORMATION (For US customers)

1. COMPLIANCE INFORMATION

Product Name: NETWORK SD/USB Recorder

Model Number: DN-700R

This product complies with Part 15 of the FCC Rules. Operation is subject to the following two conditions: (1) this product may not cause harmful interference, and (2) this product must accept any interference received, including interference that may cause undesired operation.

DENON Professional div. D&M Professional
1100 Maplewood Drive Itasca, IL 60143
Tel. 630-741-0330

2. IMPORTANT NOTICE: DO NOT MODIFY THIS PRODUCT

This product, when installed as indicated in the instructions contained in this manual, meets FCC requirements. Modification not expressly approved by DENON may void your authority, granted by the FCC, to use the product.

3. IMPORTANT

When connecting this product to network hub or router, use only a shielded STP or ScTP LAN cable which is available at retailer.

Follow all installation instructions. Failure to follow instructions could void your authority, granted by the FCC, to use the product.

4. NOTE

This product has been tested and found to comply with the limits for a Class B digital device, pursuant to Part 15 of the FCC Rules. These limits are designed to provide reasonable protection against harmful interference in a residential installation.

This product generates, uses and can radiate radio frequency energy and, if not installed and used in accordance with the instructions, may cause harmful interference to radio communications. However, there is no guarantee that interference will not occur in a particular installation. If this product does cause harmful interference to radio or television reception, which can be determined by turning the product OFF and ON, the user is encouraged to try to correct the interference by one or more of the following measures:

- Reorient or relocate the receiving antenna.
- Increase the separation between the equipment and receiver.
- Connect the product into an outlet on a circuit different from that to which the receiver is connected.
- Consult the local retailer authorized to distribute this type of product or an experienced radio/TV technician for help.

CAN ICES-3(B)/NMB-3(B)

IMPORTANT SAFETY INSTRUCTIONS

READ BEFORE OPERATING EQUIPMENT

This product was designed and manufactured to meet strict quality and safety standards. There are, however, some installation and operation precautions which you should be particularly aware of.

1. Read these instructions.
2. Keep these instructions.
3. Heed all warnings.
4. Follow all instructions.
5. Do not use this apparatus near water.
6. Clean only with dry cloth.
7. Do not block any ventilation openings. Install in accordance with the manufacturer's instructions.
8. Do not install near any heat sources such as radiators, heat registers, stoves, or other apparatus (including amplifiers) that produce heat.
9. Do not defeat the safety purpose of the polarized or grounding-type plug. A polarized plug has two blades with one wider than the other. A grounding type plug has two blades and a third grounding prong. The wide blade or the third prong are provided for your safety. If the provided plug does not fit into your outlet, consult an electrician for replacement of the obsolete outlet.
10. Protect the power cord from being walked on or pinched particularly at plugs, convenience receptacles, and the point where they exit from the apparatus.
11. Only use attachments/accessories specified by the manufacturer.

12. Use only with the cart, stand, tripod, bracket, or table specified by the manufacturer, or sold with the apparatus. When a cart is used, use caution when moving the cart/apparatus combination to avoid injury from tip-over.
13. Unplug this apparatus during lightning storms or when unused for long periods of time.
14. Refer all servicing to qualified service personnel. Servicing is required when the apparatus has been damaged in any way, such as power-supply cord or plug is damaged, liquid has been spilled or objects have fallen into the apparatus, the apparatus has been exposed to rain or moisture, does not operate normally, or has been dropped.
15. Batteries shall not be exposed to excessive heat such as sunshine, fire or the like.



Additional Safety Information!

16. This product is equipped with a three-wire grounding type plug, a plug having a third (grounding) pin. This plug will only fit into a grounding-type power outlet. If you are unable to insert the plug into the outlet, contact your electrician to replace your obsolete outlet. Do not defeat the safety purpose of the grounding-type plug.

CAUTION: (English)

To completely disconnect this product from the mains, disconnect the plug from the wall socket outlet.

The mains plug is used to completely interrupt the power supply to the unit and must be within easy access by the user.

Do not expose batteries to excessive heat such as sunshine, fire or the like.

VORSICHT: (Deutsch)

Um dieses Gerät vollständig von der Stromversorgung abzutrennen, trennen Sie bitte den Netzstecker von der Wandsteckdose ab.

Die Hauptstecker werden verwendet, um die Stromversorgung zum Gerät völlig zu unterbrechen; er muss für den Benutzer gut und einfach zu erreichen sein. Setzen Sie Batterien nicht übermäßiger Wärme aus, z. B. Sonnenstrahlung, Feuer oder dergleichen.

PRECAUTION: (Français)

Pour déconnecter complètement ce produit du courant secteur, débranchez la prise de la prise murale.

La prise secteur est utilisée pour couper complètement l'alimentation de l'appareil et l'utilisateur doit pouvoir y accéder facilement.

N'exposez pas les batteries à une chaleur excessive telle que le soleil, le feu ou autre.

ATTENZIONE: (Italiano)

Per scollegare definitivamente questo prodotto dalla rete di alimentazione elettrica, togliere la spina dalla relativa presa.

La spina di rete viene utilizzata per interrompere completamente l'alimentazione all'unità e deve essere facilmente accessibile all'utente.

Non esporre le batterie a un calore eccessivo, per esempio al sole, al fuoco o altre fonti.

PRECAUCIÓN: (Español)

Para desconectar completamente este producto de la alimentación eléctrica, desconecte el enchufe del enchufe de la pared.

El enchufe de la alimentación se utiliza para interrumpir por completo el suministro de alimentación a la unidad y debe de encontrarse en un lugar al que el usuario tenga fácil acceso.

No exponga las pilas a calor excesivo, como a la luz solar, el fuego, etc.

VOORZICHTIGHEID: (Nederlands)

Om de voeding van dit product volledig te onderbreken moet de stekker uit het stopcontact worden getrokken.

De netstekker wordt gebruikt om de stroomtoevoer naar het toestel volledig te onderbreken en moet voor de gebruiker gemakkelijk bereikbaar zijn.

Stel de batterijen niet bloot aan felle zonneschijn, brand, enzovoorts.

FÖRSIKTIHETSMÅTT: (Svenska)

Koppla loss stickproppen från eluttaget för att helt skilja produkten från nätet.

Stickproppen används för att helt bryta strömförsörjningen till apparaten, och den måste vara lättillgänglig för användaren.

Utsätt inte batterierna för stark hetta såsom solsken, eld eller liknande.

ATENÇÃO: (Português)

Para desligar completamente este produto da corrente, desligue a ficha da tomada eléctrica.

A ficha eléctrica é utilizada para interromper completamente a alimentação da unidade e deve estar num local onde o utilizador lhe possa aceder facilmente.

Não exponha as pilhas a fontes de calor excessivo, como luz solar, fogo ou semelhantes.

NOTE ON USE / HINWEISE ZUM GEBRAUCH

WARNINGS	WARNHINWEISE
<ul style="list-style-type: none"> • Avoid high temperatures. Allow for sufficient heat dispersion when installed in a rack. • Handle the power cord carefully. Hold the plug when unplugging the cord. • Keep the unit free from moisture, water, and dust. • Unplug the power cord when not using the unit for long periods of time. • Do not obstruct the ventilation holes. • Do not let foreign objects into the unit. • Do not let insecticides, benzene, and thinner come in contact with the unit. • Never disassemble or modify the unit in any way. • Ventilation should not be impeded by covering the ventilation openings with items, such as newspapers, tablecloths or curtains. • Naked flame sources such as lighted candles should not be placed on the unit. • Observe and follow local regulations regarding battery disposal. • Do not expose the unit to dripping or splashing fluids. • Do not place objects filled with liquids, such as vases, on the unit. • Do not handle the mains cord with wet hands. • When the switch is in the OFF (STANDBY) position, the equipment is not completely switched off from MAINS. • The equipment shall be installed near the power supply so that the power supply is easily accessible. • Do not keep the battery in a place exposed to direct sunlight or in places with extremely high temperatures, such as near a heater. 	<ul style="list-style-type: none"> • Vermeiden Sie hohe Temperaturen. Beachten Sie, dass eine ausreichende Belüftung gewährleistet wird, wenn das Gerät auf ein Regal gestellt wird. • Gehen Sie vorsichtig mit dem Netzkabel um. Halten Sie das Kabel am Stecker, wenn Sie den Stecker herausziehen. • Halten Sie das Gerät von Feuchtigkeit, Wasser und Staub fern. • Wenn das Gerät längere Zeit nicht verwendet werden soll, trennen Sie das Netzkabel vom Netzstecker. • Decken Sie den Lüftungsbereich nicht ab. • Lassen Sie keine fremden Gegenstände in das Gerät kommen. • Lassen Sie das Gerät nicht mit Insektiziden, Benzin oder Verdünnungsmitteln in Berührung kommen. • Versuchen Sie niemals das Gerät auseinander zu nehmen oder zu verändern. • Die Belüftung sollte auf keinen Fall durch das Abdecken der Belüftungsöffnungen durch Gegenstände wie beispielsweise Zeitungen, Tischtücher, Vorhänge o. Ä. behindert werden. • Auf dem Gerät sollten keinerlei direkte Feuerquellen wie beispielsweise angezündete Kerzen aufgestellt werden. • Bitte beachten Sie bei der Entsorgung der Batterien die örtlich geltenden Umweltbestimmungen. • Das Gerät sollte keiner tropfenden oder spritzenden Flüssigkeit ausgesetzt werden. • Auf dem Gerät sollten keine mit Flüssigkeit gefüllten Behälter wie beispielsweise Vasen aufgestellt werden. • Das Netzkabel nicht mit feuchten oder nassen Händen anfassen. • Wenn der Schalter ausgeschaltet ist (OFF (STANDBY)-Position), ist das Gerät nicht vollständig vom Stromnetz (MAINS) abgetrennt. • Das Gerät sollte in der Nähe einer Netzsteckdose aufgestellt werden, damit es leicht an das Stromnetz angeschlossen werden kann. • Lagern Sie die Batterie nicht an einem Ort, an dem sie direktem Sonnenlicht oder extrem hohen Temperaturen ausgesetzt ist, wie z. B. in der Nähe eines Heizgeräts.

❑ **OBSERVATIONS RELATIVES A L'UTILISATION / NOTE SULL'USO / NOTAS SOBRE EL USO / ALVORENS TE GEBRUIKEN / OBSERVERA / NOTA SOBRE UTILIZAÇÃO**

AVERTISSEMENTS	AVVERTENZE	ADVERTENCIAS	WAARSCHUWINGEN	VARNINGAR	AVISOS
<ul style="list-style-type: none"> • Eviter des températures élevées. Tenir compte d'une dispersion de chaleur suffisante lors de l'installation sur une étagère. • Manipuler le cordon d'alimentation avec précaution. Tenir la prise lors du débranchement du cordon. • Protéger l'appareil contre l'humidité, l'eau et la poussière. • Débrancher le cordon d'alimentation lorsque l'appareil n'est pas utilisé pendant de longues périodes. • Ne pas obstruer les trous d'aération. • Ne pas laisser des objets étrangers dans l'appareil. • Ne pas mettre en contact des insecticides, du benzène et un diluant avec l'appareil. • Ne jamais démonter ou modifier l'appareil d'une manière ou d'une autre. • Ne pas recouvrir les orifices de ventilation avec des objets tels que des journaux, nappes ou rideaux. Cela entraverait la ventilation. • Ne jamais placer de flamme nue sur l'appareil, notamment des bougies allumées. • Veillez à respecter les lois en vigueur lorsque vous jetez les piles usagées. • L'appareil ne doit pas être exposé à l'eau ou à l'humidité. • Ne pas poser d'objet contenant du liquide, par exemple un vase, sur l'appareil. • Ne pas manipuler le cordon d'alimentation avec les mains mouillées. • Lorsque l'interrupteur est sur la position OFF (STANDBY), l'appareil n'est pas complètement déconnecté du SECTEUR (MAINS). • L'appareil sera installé près de la source d'alimentation, de sorte que cette dernière soit facilement accessible. • Ne placez pas la pile dans un endroit exposé à la lumière directe du soleil ou dans des endroits présentant des températures extrêmement élevées, par exemple près d'un radiateur. 	<ul style="list-style-type: none"> • Evitate di esporre l'unità a temperature elevate. Assicuratevi che vi sia un'adeguata dispersione del calore quando installate l'unità in un mobile per componenti audio. • Maneggiate il cavo di alimentazione con attenzione. Tenete ferma la spina quando scollegate il cavo dalla presa. • Tenete l'unità lontana dall'umidità, dall'acqua e dalla polvere. • Scollegate il cavo di alimentazione quando prevedete di non utilizzare l'unità per un lungo periodo di tempo. • Non coprite i fori di ventilazione. • Non inserite corpi estranei all'interno dell'unità. • Assicuratevi che l'unità non entri in contatto con insetticidi, benzolo o solventi. • Non smontate né modificate l'unità in alcun modo. • Le aperture di ventilazione non devono essere ostruite coprendole con oggetti, quali giornali, tovaglie, tende e così via. • Non posizionate sull'unità fiamme libere, come ad esempio candele accese. • Prestate attenzione agli aspetti legati alla tutela dell'ambiente nello smaltimento delle batterie. • L'apparecchiatura non deve essere esposta a gocciolii o spruzzi. • Non posizionate sull'unità alcun oggetto contenente liquidi, come ad esempio i vasi. • Non toccare il cavo di alimentazione con le mani bagnate. • Quando l'interruttore è nella posizione OFF (STANDBY), l'apparecchiatura non è completamente scollegata da MAINS. • L'apparecchio va installato in prossimità della fonte di alimentazione, in modo che quest'ultima sia facilmente accessibile. • Non tenere la batteria in luoghi esposti alla luce solare diretta o con temperature estremamente elevate, ad esempio in prossimità di dispositivi di riscaldamento. 	<ul style="list-style-type: none"> • Evite altas temperaturas. Permite la suficiente dispersión del calor cuando está instalado en la consola. • Maneje el cordón de energía con cuidado. Sostenga el enchufe cuando desconecte el cordón de energía. • Mantenga el equipo libre de humedad, agua y polvo. • Desconecte el cordón de energía cuando no utilice el equipo por mucho tiempo. • No obstruya los orificios de ventilación. • No deje objetos extraños dentro del equipo. • No permita el contacto de insecticidas, gasolina y diluyentes con el equipo. • Nunca desarme o modifique el equipo de ninguna manera. • La ventilación no debe quedar obstruida por haberse cubierto las aperturas con objetos como periódicos, manteles o cortinas. • No deberán colocarse sobre el aparato fuentes inflamables sin protección, como velas encendidas. • A la hora de deshacerse de las pilas, respete la normativa para el cuidado del medio ambiente. • No exponer el aparato al goteo o salpicaduras cuando se utilice. • No colocar sobre el aparato objetos llenos de líquido, como jarros. • No maneje el cable de alimentación con las manos mojadas. • Cuando el interruptor está en la posición OFF (STANDBY), el equipo no está completamente desconectado de la alimentación MAINS. • El equipo se instalará cerca de la fuente de alimentación de manera que resulte fácil acceder a ella. • No coloque las pilas en un lugar expuesto a la luz directa del sol o donde la temperatura sea extremadamente alta, como cerca de una calefacción. 	<ul style="list-style-type: none"> • Vermijd hoge temperaturen. Zorg er bij installatie in een audiorack voor, dat de door het toestel geproduceerde warmte goed kan worden afgevoerd. • Hanteer het netsnoer voorzichtig. Houd het snoer bij de stekker vast wanneer deze moet worden aan- of losgekoppeld. • Laat geen vochtigheid, water of stof in het apparaat binnendringen. • Neem altijd het netsnoer uit het stopcontact wanneer het apparaat gedurende een lange periode niet wordt gebruikt. • De ventilatieopeningen mogen niet worden geblokkeerd. • Laat geen vreemde voorwerpen in dit apparaat vallen. • Voorkom dat insecticiden, benzeen of verfverdunder met dit toestel in contact komen. • Dit toestel mag niet gedemonteerd of aangepast worden. • De ventilatie mag niet worden belemmerd door de ventilatieopeningen af te dekken met bijvoorbeeld kranten, een tafelkleed of gordijnen. • Plaats geen open vlammen, bijvoorbeeld een brandende kaars, op het apparaat. • Houd u steeds aan de milieuvorschriften wanneer u gebruikte batterijen wegdoet. • Plaats geen voorwerpen gevuld met water, bijvoorbeeld een vaas, op het apparaat. • Raak het netsnoer niet met natte handen aan. • Als de schakelaar op OFF (STANDBY) staat, is het apparaat niet volledig losgekoppeld van de netspanning (MAINS). • De apparatuur wordt in de buurt van het stopcontact geïnstalleerd, zodat dit altijd gemakkelijk toegankelijk is. • Bewaar de batterijen niet op een plaats waar deze blootstaan aan direct zonlicht of op plaatsen waar zeer hoge temperaturen heersen, zoals in de buurt van een kachel. 	<ul style="list-style-type: none"> • Undvik höga temperaturer. Se till att det finns möjlighet till god värmeavledning vid montering i ett rack. • Hantera nätkabeln varsamt. Håll i kabeln när den kopplas från el-uttaget. • Utsätt inte apparaten för fukt, vatten och damm. • Koppla loss nätkabeln om apparaten inte kommer att användas i lång tid. • Tapp inte till ventilationsöppningarna. • Se till att främmande föremål inte tränger in i apparaten. • Se till att inte insektsmedel på spraybruk, bensen och thinner kommer i kontakt med apparatens hölje. • Ta inte isär apparaten och försök inte bygga om den. • Ventilationen bör inte förhindras genom att täcka för ventilationsöppningarna med föremål såsom tidningar, bordsdukar eller gardiner. • Placera inte öppen eld, t.ex. tända ljus, på apparaten. • Tänk på miljöaspekterna när du bortskaffar batterier. • Apparaten får inte utsättas för vätska. • Placera inte föremål fyllda med vätska, t.ex. vaser, på apparaten. • Hantera inte nätsladden med våta händer. • Även om strömbrytaren står i det avstängda läget OFF (STANDBY), så är utrustningen inte helt bortkopplad från det elektriska nätet (MAINS). • Utrustningen ska vara installerad nära strömuttaget så att strömförsörjningen är lätt att tillgå. • Förvara inte batteriet på en plats som utsätts för direkt solljus eller på platser med extremt höga temperaturer, som nära ett värmeelement. 	<ul style="list-style-type: none"> • Evite temperaturas altas. Assegure uma suficiente dispersão de calor quando a unidade for instalada numa prateleira. • Manuseie o cabo de alimentação com cuidado. Puxe pela ficha quando desligar o cabo de alimentação. • Mantenha a unidade afastada da humidade, da água e do pó. • Desligue o cabo de alimentação quando não estiver a utilizar a unidade por longos períodos de tempo. • Não obstrua os orifícios de ventilação. • Não deixe objectos estranhos dentro da unidade. • Não permita que insecticidas, benzina e diluente entrem em contacto com a unidade. • Nunca desmonte ou modifique dealguma forma a unidade. • A ventilação não deve ser obstruída, tapando as aberturas de ventilação com objectos, como jornais, toalhas ou cortinas. • Não devem ser colocadas junto à unidade fontes de chama aberta, como velas acesas. • Respeite as regulamentações locais relativas à eliminação de pilhas. • Não exponha a unidade a gotejamento ou salpicos de líquidos. • Não coloque objectos com líquidos, como jarros, em cima da unidade. • Não manuseie o cabo de alimentação com as mãos molhadas. • Quando o interruptor se encontra na posição OFF (STANDBY), o equipamento não está completamente desligado da REDE ELÉCTRICA. • O equipamento deve ser instalado junto da fonte de alimentação, para que a fonte de alimentação esteja facilmente acessível. • Não deixe a pilha num local exposto à luz solar directa ou em locais sujeitos a temperaturas extremamente elevadas, como, por exemplo, junto de um aquecedor.

• DECLARATION OF CONFORMITY

Our products following the provisions of EC/EU directives, that as follows:

LV: 2006/95/EC

EMC: 2004/108/EC

RoHS: 2011/65/EU

ErP: EC regulation 1275/2008 and its frame work directive 2009/125/EC

• ÜBEREINSTIMMUNGSERKLÄRUNG

Unsere Produkte unterliegen den Bestimmungen der folgenden EG/EU-Richtlinien:

LV: 2006/95/EC

EMC: 2004/108/EC

RoHS: 2011/65/EU

ErP: EG-Vorschrift 1275/2008 und deren Rahmenrichtlinie 2009/125/EC

• DECLARATION DE CONFORMITE

Nos produits sont conformes aux dispositions des directives CE/UE comme suit ;

LV: 2006/95/EC

EMC: 2004/108/EC

RoHS: 2011/65/EU

ErP: Réglementation CE 1275/2008 et sa directive cadre 2009/125/CE

• DICHIARAZIONE DI CONFORMITÀ

I nostri prodotti sono conformi a quanto previsto dalle direttive EC/EU, come specificato di seguito:

LV: 2006/95/EC

EMC: 2004/108/EC

RoHS: 2011/65/EU

ErP: Norma EC 1275/2008 e relativa legge quadro 2009/125/EC

• DECLARACIÓN DE CONFORMIDAD

Nuestros productos cumplen las disposiciones de las directivas de la CE/UE siguientes:

LV: 2006/95/EC

EMC: 2004/108/EC

RoHS: 2011/65/EU

ErP: Normativa de la CE 1275/2008 y su directiva marco 2009/125/CE

• EENVORMIGHEIDSVKLAARING

Onze producten volgen de voorwaarden van de EG/EU-richtlijnen zoals volgt;

LV: 2006/95/EC

EMC: 2004/108/EC

RoHS: 2011/65/EU

ErP: EG-verordening 1275/2008 en zijn kaderrichtlijn 2009/125/EG

• ÖVERENSSTÄMMELSESINTYG

Våra produkter uppfyller följande föreskrifter i EC/EU-direktiv:

LV: 2006/95/EC

EMC: 2004/108/EC

RoHS: 2011/65/EU

ErP: EU-direktiv 1275/2008 och dess ramdirektiv 2009/125/EC

• DECLARAÇÃO DE CONFORMIDADE

Nossos produtos seguem as disposições da CE / UE directivas, que, como se segue;

LV: 2006/95/EC

EMC: 2004/108/EC

RoHS: 2011/65/EU

ErP: Regulamento (CE) 1275/2008 e a respectiva Directiva-Quadro 2009/125/CE

D&M Professional Europe
A division of D&M Europe B.V
Beemdstraat 11
5653 MA Eindhoven
The Netherlands

A NOTE ABOUT RECYCLING:

This product's packaging materials are recyclable and can be reused. Please dispose of any materials in accordance with the local recycling regulations.

When discarding the unit, comply with local rules or regulations.

Batteries should never be thrown away or incinerated but disposed of in accordance with the local regulations concerning battery disposal.

This product and the supplied accessories, excluding the batteries, constitute the applicable product according to the WEEE directive.

HINWEIS ZUM RECYCLING:

Das Verpackungsmaterial dieses Produktes ist zum Recyceln geeignet und kann wieder verwendet werden. Bitte entsorgen Sie alle Materialien entsprechend der örtlichen Recycling-Vorschriften.

Beachten Sie bei der Entsorgung des Gerätes die örtlichen Vorschriften und Bestimmungen.

Die Batterien dürfen nicht in den Hausmüll geworfen oder verbrannt werden; bitte entsorgen Sie die Batterien gemäß der örtlichen Vorschriften.

Dieses Produkt und das im Lieferumfang enthaltene Zubehör (mit Ausnahme der Batterien!) entsprechen der WEEE-Direktive.

UNE REMARQUE CONCERNANT LE RECYCLAGE:

Les matériaux d'emballage de ce produit sont recyclables et peuvent être réutilisés. Veuillez disposer des matériaux conformément aux lois sur le recyclage en vigueur.

Lorsque vous mettez cet appareil au rebut, respectez les lois ou réglementations en vigueur.

Les piles ne doivent jamais être jetées ou incinérées, mais mises au rebut conformément aux lois en vigueur sur la mise au rebut des piles.

Ce produit et les accessoires inclus, à l'exception des piles, sont des produits conformes à la directive DEEE.

NOTA RELATIVA AL RICICLAGGIO:

I materiali di imballaggio di questo prodotto sono riutilizzabili e riciclabili. Smaltire i materiali conformemente alle normative locali sul riciclaggio.

Per lo smaltimento dell'unità, osservare le normative o le leggi locali in vigore.

Non gettare le batterie, né incenerirle, ma smaltirle conformemente alla normativa locale sui rifiuti chimici.

Questo prodotto e gli accessori inclusi nell'imballaggio sono applicabili alla direttiva RAEE, ad eccezione delle batterie.

ACERCA DEL RECICLAJE:

Los materiales de embalaje de este producto son reciclables y se pueden volver a utilizar. Disponga de estos materiales siguiendo los reglamentos de reciclaje de su localidad.

Cuando se deshaga de la unidad, cumpla con las reglas o reglamentos locales.

Las pilas nunca deberán tirarse ni incinerarse. Deberá disponer de ellas siguiendo los reglamentos de su localidad relacionados con los desperdicios químicos.

Este producto junto con los accesorios empaquetados es el producto aplicable a la directiva RAEE excepto pilas.

EEN AANTEKENING MET BETREKKING TOT DE RECYCLING:

Het inpakmateriaal van dit product is recycleerbaar en kan opnieuw gebruikt worden. Er wordt verzocht om zich van elk afvalmateriaal te ontdoen volgens de plaatselijke voorschriften.

Volg voor het wegdoen van de speler de voorschriften voor de verwijdering van wit- en bruingoed op.

Batterijen mogen nooit worden weggegooid of verbrand, maar moeten volgens de plaatselijke voorschriften betreffende chemisch afval worden verwijderd.

Op dit product en de meegeleverde accessoires, m.u.v. de batterijen is de richtlijn voor afgedankte elektrische en elektronische apparaten (WEEE) van toepassing.

OBSERVERA ANGÅENDE ÅTERVINNING:

Produktens emballage är återvinningsbart och kan återanvändas. Kassera det enligt lokala återvinningsbestämmelser. När du kasserar enheten ska du göra det i överensstämmelse med lokala regler och bestämmelser.

Batterier får absolut inte kastas i soporna eller brännas. Kassera dem enligt lokala bestämmelser för kemiskt avfall.

Denna apparat och de tillbehör som levereras med den uppfyller gällande WEEE-direktiv, med undantag av batterierna.

UMA NOTA SOBRE A RECICLAGEM:

Os materiais de embalagem deste produto são recicláveis e podem ser reutilizados. Elimine quaisquer materiais de acordo com as normas de reciclagem locais.

Quando eliminar a unidade, obedeça às regras ou normas locais.

As pilhas nunca devem ser deitadas fora ou incineradas, mas sim eliminadas de acordo com as normas locais relativas aos resíduos químicos.

Este produto e os respectivos acessórios embalados em conjunto constituem o produto aplicável de acordo com a directiva WEEE, excepto as pilhas.



Pb

Getting started

Thank you for purchasing this DENON Professional product. To ensure proper operation, please read this owner's manual carefully before using the product. After reading, be sure to keep for future reference.

Contents

Getting started	1
Main Features	3
Accessories	4
Cautions on handling	4
Part names and functions	5
Front Panel	5
Rear Panel	7
Display	8
Switching the display	8
Playback/pause/search/stop display	8
Properties display (Playback/pause/search/stop)	9
Display during recording and when recording is paused	10
Connections	11
Preparations	11
Cables used for audio connection	11
Audio connections	11
Analog connection (unbalanced connection)	11
Analog connection (balanced connection)	11
Digital connection (COAXIAL)	11
Digital connection (AES/EBU)	11
Connecting the microphone	12
Connecting the external control terminal	12
Parallel port	12
RS-232C terminal	12
Connecting headphones	12
Connecting the power cord	13
Mounting recording media	13
SD card	13
Connecting a USB device	14
Cautions when recording media is mounted	14
Setting defaults	15
Menu List	15
Setting defaults	17
Menu operations	
(Preset selection/Preset setting/System setting)	17
Menu Operations (Utility)	24
Selecting Media	27
Media List	27
Media Server List	27
Selecting Files and Folders	28
File List	28
File List Menu	28
Playing back files (01 Preview)	29
Selecting all files for copying/moving/deleting (02 Select All)	29
Changing the file name or folder name (03 Rename)	29
Deleting Files and Folders (04 Delete)	29
Copying Files and Folders (05 Copy)	30
Moving files (06 Move)	30
Creating folders (07 Make Folder)	30
Deleting marks (08 Delete Mark)	31
File information (09 Property)	31
Other functions	31
Locking operation buttons (Key lock)	31
Recording	32
Selecting the recording media or folder for storing the recorded files	32
Recording	32
Recording Monitor	34
Dual recording	34
Relay recording	34
Timer Recording	35
Timer recording start time and recording time settings	35
Turning timer recording on/off	36
Editing timer recording information	37
Using timer recording	37
Add a file during recording (Manual track)	38
Adding marks (Marking)	38
Silent skip recording	38
Operations during recording	38
Recording time chart	39

Playback	40
Selecting files to playback	40
Playback	40
Operations during playback	41
Changing files	41
Fast forward and fast rewind (Search)	41
Jumping by frames (Frame jump)	41
Rewind a specified amount of time and playback (Skip back)	41
Playback pitch adjustment (Pitch control)	42
Add marks (marking)	42
Searching for Marks	42
Random playback	42
Program playback	43
Create program	43
Program playback	44
Editing the program	44
Saving/reading program data	44
Timer playback	45
Timer playback start time and playback file settings	45
Turning timer playback on/off	45
Editing timer playback information	46
Using timer playback	46
Hot Start	47
Registering tracks to a hot list	47
Deleting a hot list file	47
Saving/reading hot list data	47

Edit Function	48
EDIT	48
COMBINE	48
DIVIDE	48
COPY	49
MOVE	49
UNDO	49

Control Function	50
USB Keyboard	50
Connecting to a network (LAN)	51
Required system	51
Network Settings	52
LAN Connection	52
Archive	53
Menu operations (archive)	53
Other Functions (Product Manager)	55
Installation of Product Manager	55
Product Manager window	56
Operations	57
Web Remote	58
Various playback functions with RC-F400S	65
Part names and functions	65
Connection	67
Hot Start playback	68
Playback from the main screen	70
Serial remote control function	71
RS-232C control	71
IP control (Ethernet)	71
D&M RC communication format	72
Parallel control	74

Information	76
Error messages	76
Troubleshooting	77
Main specifications	79
Appendix	81
License	106

Main Features

Interface

- Equipped with two SD/SDHC card slots (max 32 GB per card slot) and one USB2.0 (high speed) compatible drive connector
- Equipped with a USB2.0 (low speed) compatible keyboard connector for file name editing and control using a keyboard
- Equipped with a serial control connector (RS-232C) for connection to an RC-F400S or command control
- Equipped with a parallel remote connector (25Pin D-sub) for remote control without a computer
- Equipped with a LAN connector for network functions such as compatibility with network streaming playback, file transfer, control and monitoring with Web Remote and IP control, etc.

Audio

- Equipped with XLR (analog/digital) and RCA (analog/digital) input/output connectors for ensuring high connectivity with various devices using the standard level setting function
- Equipped with a headphone jack with volume control knob to respond to a wide range of needs such as recording monitoring, etc.
- Equipped with a microphone pre amp with independent left and right phantom switches and gain control.
- Equipped with SRC (sampling rate converter) on the digital output section that automatically converts different sampling rates from the source playback to a digital output with a fixed output sampling rate

NOTE

The reproduction or use of materials such as music data or files may be restricted under the Copyright Act or other applicable laws, or under the terms of a license agreement between yourself and the material owner. Check that the conditions of use for all materials are thoroughly satisfied before reproduction etc., and use this equipment correctly. DENON Professional cannot accept any responsibility whatsoever for acts of copyright infringement undertaken by the user.

Functions

- Equipped with a dual recording function that enables simultaneous recording from two SD cards or USB devices, further improving backup capabilities
- Equipped with a relay recording function that continues recording on a different media when the remaining free space on the original recording media falls below 2MB, enabling long recording without the sound cutting out
- Equipped with a recording monitor function for simultaneous monitoring of recorded data, enabling reliable monitoring of the recording status
- Equipped with a timer recording/timer playback function that enables scheduled recording/playback for automatic recording or automatic playback of scheduled events
- Equipped with an editing function (merge/divide/copy/move/undo) and USB keyboard file name input function for editing files from a computer, etc.
- Equipped with a pitch control and master key function for fine adjustment of the playback speed
- In addition to mark editing/playback from the unit panel, the provided “DMP Mark Editor” can be used to effectively edit mark points from a computer

Network

- File streaming playback and file backup can be done via the network
- The unit can be configured as a DMP (Digital Media Player), a server system can be constructed easily using NAS, and the unit can be controlled using a DLNA compatible device
- Compatible with various controls from sources such as Web Remote and IP control, enabling remote control and monitoring on a computer
- FTP (File Transfer Protocol) server support
- Equipped with an archive function that transfers files to a server automatically after the recording is finished or at a set time, ensuring continuous long recording and improving backup capabilities
- Compatible with NTP (Network Time Protocol) enabling automatic time adjustment
- Preset data can be uploaded or downloaded from the host computer

Accessories

Check that the following parts are supplied with the product.

- ① Quick start guide (Book) 1
- ② Power cords for each region (US,EU)..... 1 of each
- ③ CD-ROM..... 1
 - DN-700R Instruction manual
 - DMP Mark Editor Installer
 - DMP Mark Editor Instruction manual
 - DENON Professional Product Manager Installer
 - DENON Professional Product Manager Owner's Manual
- ④ Security Screw for SD card door 4
- ⑤ Plastic pin and retainer 2 of each
(plastic pin and retainer is attached to the SD card door at the time of purchase.)

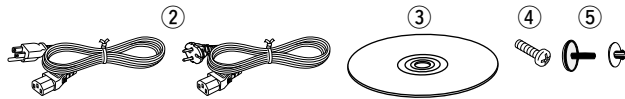

Cautions on handling

• Before turning the power switch on

- Check once again that all connections are correct and that there are no problems with the connection cables.
- Power is supplied to some of the circuitry even when the unit is set to the standby mode. When not using the machine for long periods of time, be sure to unplug the power cord from the power outlet.

• About condensation

If there is a major difference in temperature between the inside of the unit and the surroundings, condensation may form on parts inside the unit, causing the unit to fail to operate properly.

If this happens, let the unit sit for an hour or two with the power off and wait until there is little difference in temperature before using the unit.

• Cautions on using mobile phones

Using a mobile phone near this unit may result in noise. If that occurs, move the mobile phone away from the unit when it is in use.

• Moving the unit

Turn off the power and unplug the power cord from the power outlet. Next, disconnect the cables connected to other system units before moving the unit.

• Rack mount cautions (Required rack specifications for mounting the DN-700R on a rack)

- EIA Standard 19 inch rack
- 1U Size installation compatible rack
- Rack that has a guide rail or shelf board that can support this device

Part names and functions

Front Panel

For buttons not explained here, see the page indicated in parentheses ().

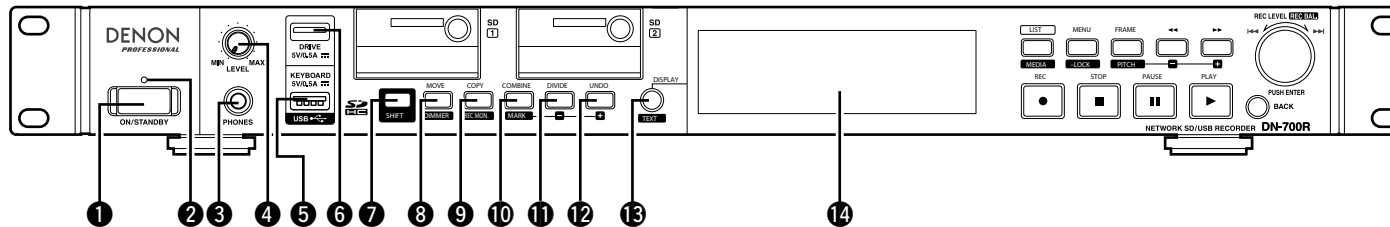

- 1 Power switch (ON/STANDBY)**
 - Turns the unit power on and off (standby).
- 2 Power indicator**
 - Power on: Off
 - Normal standby: Red
 - Network standby: Orange
- 3 Headphone jack (PHONES)** (12)
 - Connect the headphones.
- 4 Headphone Volume Adjustment Knob (LEVEL)** (12)
 - Adjusts the volume of the headphones.
 - Press the knob to make it spring out. After adjusting the volume, press the knob back in again.
- 5 USB connector for keyboard (KEYBOARD)** (50)
 - Connect a USB keyboard.
- 6 USB connector for USB device (DRIVE)** ... (14)
 - Connect a USB device.

- 7 SHIFT button**
 - Allows access to features indicated under each button.
 - The shift mode is enabled when the **SHIFT** button is lit (☞page 18 “02 Shift Mode”).
- 8 MOVE/DIMMER button** (20, 49)
 - Moves the file of the current track.
 - Press when the **SHIFT** button is lit to switch the display brightness of the display and LED.
 - The brightness of the dimmer can be set in “36 Display Dimmer” (☞page 20) and “37 LED Dimmer” (☞page 20) in the “Preset Setting”.

- 9 COPY/REC MON. button** (30, 34, 49)
 - Copies the file of the selected track.
 - Press when the **SHIFT** button is lit to switch the recording monitor on or off.
 - The LED lights when the recording monitor is on.
- 10 COMBINE/MARK button** (38, 42, 48)
 - Combines the selected track with a different track.
 - Press when the **SHIFT** button is lit to adds a mark to the current playback or recording position.
- 11 DIVIDE/MARK – button**..... (38, 42, 48)
 - Divides the currently selected track at the current playback position.
 - Divides the recording track at the current recording position.
 - Press when the **SHIFT** button is lit to jump to the mark prior to the current playback position.

- 12 UNDO/MARK + button** (42, 49)
 - Undoes the prior edit.
 - Press when the **SHIFT** button is lit to jump to the mark after the current playback position.
- 13 DISPLAY/TEXT button** (8, 9)
 - Switches the display.
 - Press when the **SHIFT** button is lit to scroll the text display.
- 14 Display** (8)

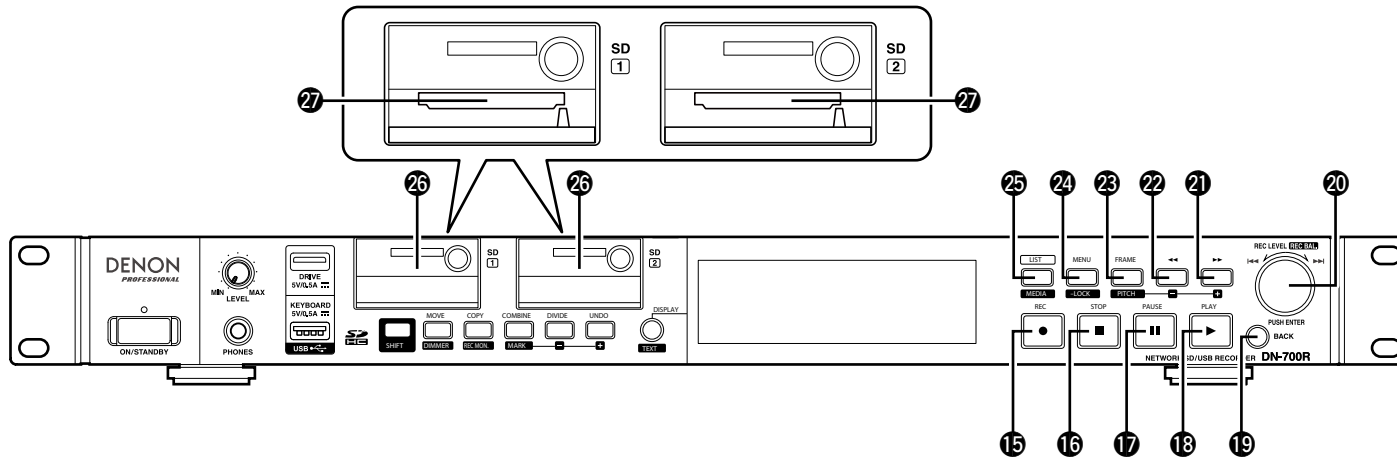

- 15 REC button (●)**..... (32)
 - When “08 One Touch Rec” (☞page 18) in “Preset Setting” is “Off”, press the button once to enter the record pause mode and press again to start recording.
 - When “08 One Touch Rec” (☞page 18) in “Preset Setting” is “On”, press the button once to start recording.
 - The **REC** button lights during recording.
 - The **REC** button flashes during recording is paused.
- 16 STOP button (■)**..... (17, 40)
 - Press the button during playback or when playback is paused to stop playback. These operations can be set in “23 Finish Mode” (☞page 19) of “Preset Setting”.
 - Press the button during recording or when recording is paused to stop recording and standby at the start of the last recorded file.
 - The **STOP** button lights when a track is stopped or cued.
 - Press when a track is cued to stop.
- 17 PAUSE button (II)** (33, 40)
 - Press the button during playback or recording to pause playback or recording.
 - The **PAUSE** button lights when playback or recording is paused.
- 18 Play button (▶)**..... (40)
 - Starts playback.
 - The **PLAY** button lights during playback or when playback is paused.
- 19 BACK button**
 - Returns to the previous menu.
 - When the file list is displayed, press the **SHIFT** button when it is lit to move the cursor to the top of the list.
- 20 Jog Dial/PUSH ENTER button**
 - Rotate the dial to skip tracks.
 - Used to adjust the recording level during recording or when recording is paused.
 - Used to move the cursor or select setting items when the menu is displayed.
 - Rotate the dial when the **SHIFT** button is lit to adjust the recording level or recording balance during recording or when recording is paused.
 - Press the button to enter the setting item or menu.
- 21 Fast Forward/Pitch + button (▶▶)** (41, 42)
 - Fast forwards the track.
 - In frame mode, this button jumps frame units in the forward direction.
 - Press when the **SHIFT** button is lit to set the pitch.
- 22 Fast Rewind/Pitch - button (◀◀)** (41, 42)
 - Fast rewinds the track.
 - In frame mode, this button jumps frame units in the reverse direction.
 - Press when the **SHIFT** button is lit to set the pitch.
- 23 FRAME/PITCH button** (41, 42)
 - Switches the functions of buttons ◀◀ and ▶▶ to frame mode or search mode.
 - The **FRAME** button lights in frame mode.
 - Press when the **SHIFT** button is lit to switch the pitch on or off. The **PITCH** button lights when Pitch is on.
- 24 MENU/LOCK button** (15, 17, 31)
 - Displays the menu.
 - Press when the **SHIFT** button is lit to lock the operation buttons on the unit. The **LOCK** button lights when the key lock is on.
- 25 LIST/MEDIA button**..... (27, 28, 32, 40)
 - The “File List” is displayed.
 - Press when the **SHIFT** button is lit to display the media list for switching media.
- 26 SD Card Door**..... (13)
- 27 SD Card Slot 1/2**..... (13)
 - Insert an SD/SDHC card (max. 32GB). SDXC and UHS are not supported.

Rear Panel

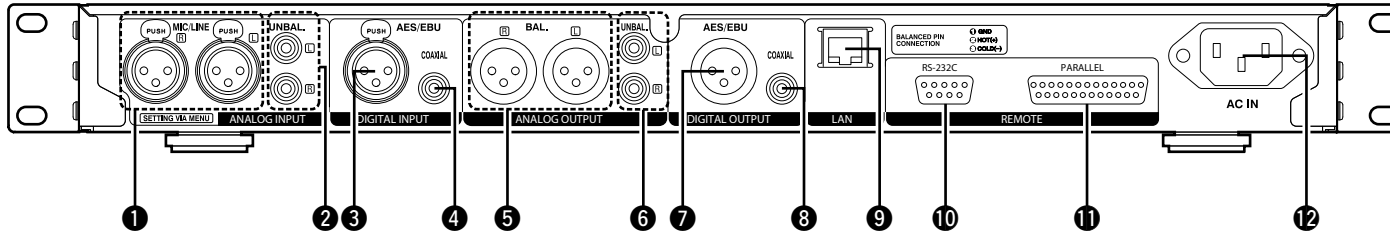

- | | | |
|---|---|---|
| <p>1 Analog input (Balanced) terminal (11)</p> <ul style="list-style-type: none"> • XLR Type • Pin Arrangement: 1. GND / 2. Hot (w/ Phantom) / 3. Cold • The line input level can be changed using "14 Volume Input" (page 22) in "System Setting". • The input mode can be switched using "08 Line/Mic Lch"/"09 Line/Mic Rch" (page 22) in "System Setting". <p>2 Analog input (Unbalanced) terminal (11)</p> <ul style="list-style-type: none"> • RCA Type <p>3 Digital input (XLR) terminal (11)</p> <ul style="list-style-type: none"> • XLR Type • IEC60958 Type I • Pin Arrangement: 1. Common / 2. Hot / 3. Cold <p>4 Digital input (RCA) terminal (11)</p> <ul style="list-style-type: none"> • IEC60958 Type II | <p>5 Analog output (balanced) terminal (11)</p> <ul style="list-style-type: none"> • XLR Type • Pin Arrangement: 1. GND / 2. Hot / 3. Cold <p>6 Analog output (unbalanced) terminal (11)</p> <ul style="list-style-type: none"> • RCA Type <p>7 Digital output (XLR) terminal (11)</p> <ul style="list-style-type: none"> • IEC60958 Type I (AES/EBU) • Pin Arrangement: 1. Common / 2. Hot / 3. Cold <p>8 Digital output (RCA) terminal (11)</p> <ul style="list-style-type: none"> • IEC60958 Type II (COAXIAL) | <p>9 LAN Terminal (52)</p> <ul style="list-style-type: none"> • IEEE 802.3u (3.3V I/O) / 10 / 100Base-T(X) / RJ-45 <p>10 RS-232C Terminal (12, 71)</p> <ul style="list-style-type: none"> • 9pin DSUB Connector (Female) <p>11 Parallel port (PARALLEL) (12, 74)</p> <ul style="list-style-type: none"> • 25pin DSUB Connector (Female) <p>12 AC Inlet (AC IN) (13)</p> <ul style="list-style-type: none"> • Connect the supplied power cord. |
|---|---|---|

Display

The playback status and information about various media is displayed on the DN-700R display. Details of the display differ depending on the operating status (stopped/recording/playing) of the DN-700R.

Switching the display

Press DISPLAY.

- The display details change each time the button is pressed.

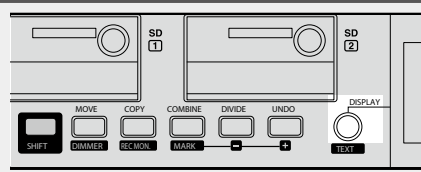

Playback/pause/search/stop display

- The properties display can also be switched using DISPLAY.

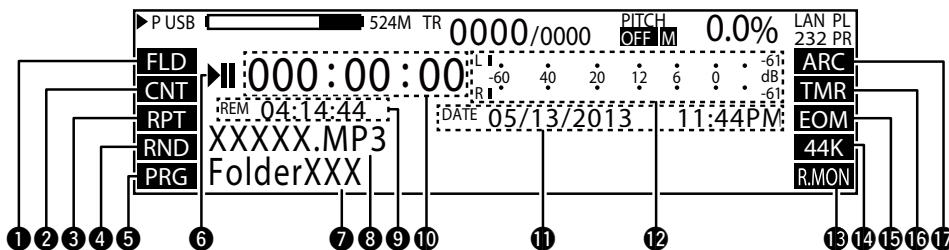

1 Playback range display

- Displays the current playback range.
- Displays the settings configured in "19 Play Range" (page 19) in "Preset Setting".
- FLD: Current folder/ALL: All folders

2 Playback mode display

- Displays the settings configured in "20 Play Mode" (page 19) in "Preset Setting".
- CNT: Continuous playback
- SGL: 1 track playback

3 Repeat playback display

- Displays the settings configured in "24 Repeat" (page 19) in "Preset Setting".
- RPT: Displayed when repeat playback is on.

4 Random playback display

- Displays the settings configured in "21 Random" (page 19) in "Preset Setting".
- RND: Displayed when random playback is on.

5 Programmed playback display

- Displays the settings configured in "22 Program" (page 19) in "Preset Setting".
- PRG: Displayed when programmed playback is on.

6 Status display

- Displays the operating status.

STOP	■
CUE	■ CUE
PAUSE	
AUDIBLE PAUSE	
SEARCH	◀▶
PLAY	▶
REC PAUSE	●
REC	●

7 Folder name

- Displays the path to the selected folder.

8 Track name

- Displays the selected track name.

9 Remaining time display

- Displays the remaining time of the current track.
- The display format can be set in "33 Time Display" (page 20) in "Preset Setting".
- When the selected track is VBR (Variable Bit Rate) format, the estimated remaining time is displayed.

10 Elapsed time display

- The elapsed time of the currently selected track is displayed.
- The display format can be set in "33 Time Display" (page 20) in "Preset Setting".

11 Time/Date display

- The current date and time are displayed when playback is stopped.
- During playback, the date and time when the selected track was created are displayed.
- The display format can be set in "20 Time Form" and "21 Date Form" (page 22) in "Preset Setting".

12 Playback level display

- Displays the playback level.
- With a three-second peak hold.

13 Recording monitor display

- Displays the recording monitor status.
- R.MON: Displayed when the recording monitor is on.

14 Sampling rate display

- Displays the sampling rate of the audio output. (44 K/48 K/96 K)
- When a sampling rate is not applied when Ext(AES) is used, "EXT" flashes in the display. Nothing is displayed when "Auto" is used.

15 End of track notification display

- "EOM" is displayed when a setting other than "Off" is set for "31 End Of Message" (page 20) in "Preset Setting".

16 Timer Display

- "TMR" is displayed when the "Timer Recording" (page 35) or "Timer playback" (page 45) is set.

17 Archive Display

- "ARC" is displayed when a setting other than "Off" is set for "Archive Mode" (page 54) in "Archive Setting".
- It flashes while archiving is being executed.

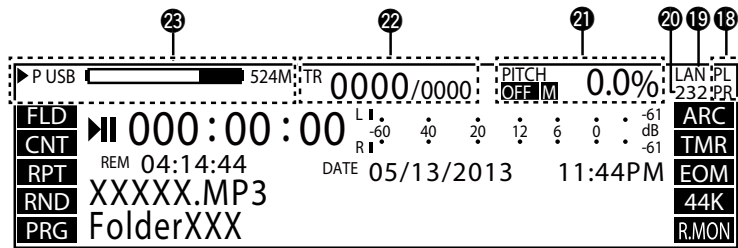

18 Phantom power display

- Displayed when the phantom power setting is set to on in “10 Phantom Lch” (PL) and “11 Phantom Rch” (PR) (page 22) in “System Setting”.

19 Ethernet Display

- Displayed when the Ethernet can be used.

20 Remote serial connection display

- Lights when remote serial commands are being received.

21 Pitch display

- Displays the ON/OFF status of the pitch function, master key and playback speed (percentage).
- “M” is displayed when the master key is on.

22 Track number display

- The right side displays the total number of tracks on the selected media, and the left side displays the selected track number.

23 Media display

- Displays the type of currently selected media (SD1/SD2/USB/NET) and the amount of free space.
- The currently selected media is set in the upper part and “P” is displayed in front of the media.
- The backup media (dual recording) is set in the lower part (when applicable) and “B” is displayed in front of the media. When a secondary media (relay recording) is set, “S” is displayed in front of the media.
- If there is no free space on the lower media, “MEDIA FULL” is displayed.
- If the lower media reaches 2000 tracks, “TRACK FULL” is displayed.
- If writing is prohibited to the lower media, “WRITE LOCK” is displayed.
- “▶” indicates the currently selected media.
- The free space is not displayed when the media is “NET”.

Properties display (Playback/pause/search/stop)

- Property
- 0001 BGM_001.mp3(/Full/Path)
- 01/02/2013 10:23:45AM
- 44K Mo 320kbps
- “Album”, “Title”, “Artist”

1 Title Name

2 Track number/file name

- Displays the selected track number and file name.
- The path to the folder in which the file is stored is displayed in the parentheses ().

3 Time/Date Display

- Displays the date and time when the selected track was created.
- The display format can be set in “20 Time Form” and “21 Date Form” (page 22) in “Preset Setting”.

4 Track recording information

- Sampling rate
- Channel
- St: Stereo / Mo: Monaural
- Number of quantization bits or bit rate

5 Album name

- Only for MP3 files, the album name within the ID3 tag is displayed.

Title

- Only for MP3 files, the title name within the ID3 tag is displayed.

Artist

- Only for MP3 files, the artist name within the ID3 tag is displayed.



If the text information does not fit in the display, press **TEXT** in shift mode to scroll and display the hidden text.

Display during recording and when recording is paused

• Press **DISPLAY** to switch to an enlarged level meter display.

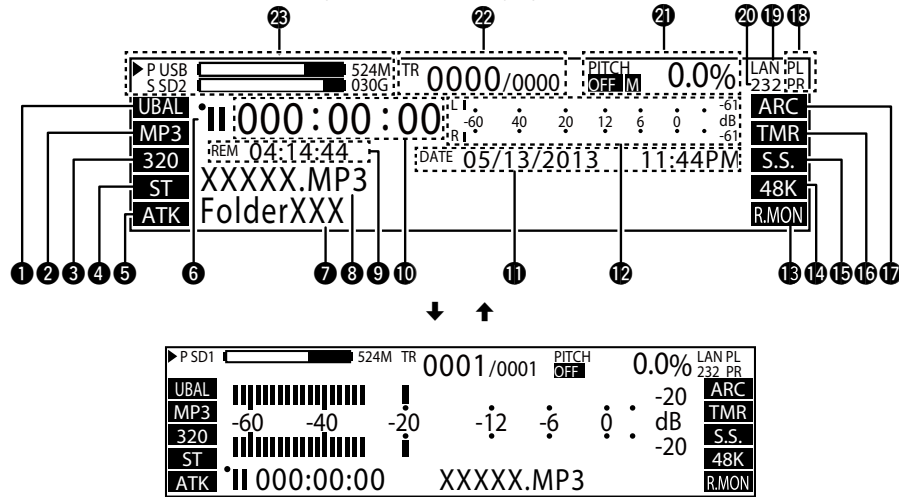

1 Recording input display

- Displays "09 Audio Input" (page 18) of the current "Preset Setting".
- UBAL: Unbalanced / BAL: Balanced / AES: AES/EBU / COAX: Coaxial

2 Recording file display

- Displays "10 Rec Format" (page 18) of "Preset Setting".
- MP3 / WAV

3 Recording format display

- Displays "10 Rec Format" (page 18) of "Preset Setting".
- MP3: Bit rate / WAV: No. of quantization bits

4 Recording channel display

- Displays "11 Rec Channel" (page 18) of the current "Preset Setting".
- ST: Stereo / MONO: Mono (Lch) / MIX: Lch Rch Mix

5 Auto track display

- Displays "ATK" when "14 Auto Track" (page 18) of the current "Preset Setting" is on.

6 Status display

- Displays the operating status.

STOP	■
CUE	CUE
PAUSE	
AUDIBLE PAUSE	
SEARCH	◀▶
PLAY	▶
REC PAUSE	⏸
REC	●

7 Folder name display

- Displays the path to the selected folder.

8 Track name display

- Displays the progress bar when "14 Auto Track" (page 18) of "Preset Setting" is set to anything other than off.

9 Remaining time display

- Displays the remaining recordable time on the selected media.
- The display format can be set in "33 Time Display" (page 20) in "Preset Setting".
- "----:" is displayed if the format cannot be applied to the remaining time display.

10 Elapsed time display

- Displays the elapsed recording time of the current track.
- The display format can be set in "33 Time Display" (page 20) in "Preset Setting".

11 Time/Date display

- The recording start date and time are displayed during the recording operation.

12 Recording level meter

- Displays the recording level. With a three-second peak hold.

13 Recording monitor display

- Displays the recording monitor status.
R.MON: Displayed when the recording monitor is on.

14 Displays the recording sample rate

- Recording sampling rate.
- Displays "12 Sample Rate" (page 18) of "Preset Setting".
- When a sampling rate is not applied when Ext(AES) is used, "EXT" flashes in the display.

15 Silent skip display

- Displays "S.S." when "16 Silent Skip" (page 19) of "Preset Setting" is on.

16 Timer Display

- "TMR" is displayed when the "Rec Timer" (page 35) or "Play Timer" (page 45) is set.

17 Archive Display

- "ARC" is displayed when a setting other than "Off" is set for "Archive Mode" (page 54) in "Archive Setting".
- It flashes while archiving is being executed.

18 Phantom power display

- Displayed when phantom power is on.
- Displayed when "10 Phantom Lch" (PL) and "11 Phantom Rch" (PR) (page 22) are on in "System Setting".

19 Ethernet Display

- Displayed when the Ethernet can be used.

20 Remote serial connection display

- Displayed when the remote serial command is being received.

21 Pitch display

- Displays the ON/OFF status of the pitch function, master key and playback speed (percentage).
- "M" is displayed when the master key is on.

22 Track number display

- The right side displays the total number of tracks on the selected media, and the left side displays the selected track number.

23 Media display

- Displays the type of currently selected media (SD1/SD2/USB/NET) and the amount of free space.
- The currently selected media is set in the upper part (when applicable) and "P" is displayed in front of the media.
- The backup media (dual recording) is set in the lower part (when applicable) and "B" is displayed in front of the media. When a secondary media (relay recording) is set, "S" is displayed in front of the media.
- If there is no free space on the lower media, "MEDIA FULL" is displayed.
- If the lower media reaches 2000 tracks, "TRACK FULL" is displayed.
- If writing is prohibited to the lower media, "WRITE LOCK" is displayed.
- "▶" indicates the currently selected media.
- The free space is not displayed when the media is "NET".

Connections



NOTE

- Do not plug in the power cord until all connections have been completed.
- When making connections, also refer to the operating instructions of the other components.
- Insert the plugs securely. Loose connections will result in the generation of noise.
- Be sure to connect the left and right channels properly (left with left, right with right).
- Connect the cables to the correct input and output terminals.
- Do not bundle power cords together with connection cables. Doing so can result in humming or noise.

Preparations

Cables used for audio connection

Select the cables according to the equipment being connected.

Audio cables	
Analog Connection (RCA)	
	Stereo audio cable (Sold separately)
Digital Connection (RCA)	
	Coaxial digital cable (Sold separately)
Analog Connection (XLR), Digital Connection (XLR)	
	Balanced cable (Sold separately)

Audio connections

Analog connection (unbalanced connection)

Connect line-level analog inputs/outputs to the analog (unbalanced) input/output terminals for playback or recording.

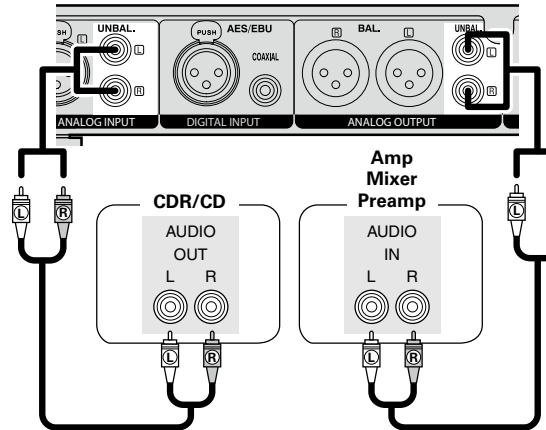

Analog connection (balanced connection)

Connect line-level analog inputs/outputs to the analog (balanced) input/output terminals for playback or recording.

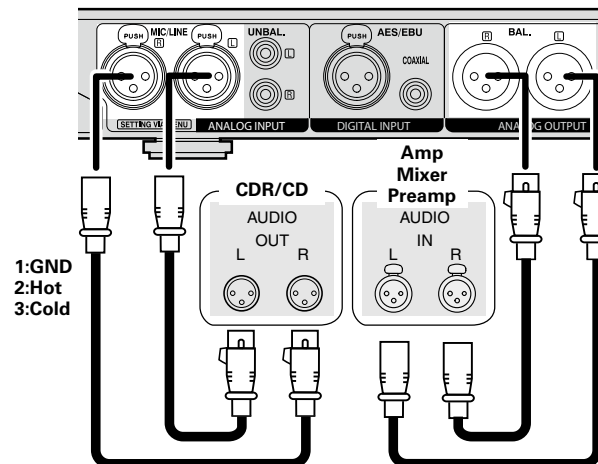

Digital connection (COAXIAL)

Connect digital inputs/outputs to the digital input/output (COAXIAL) connectors for playback or recording.

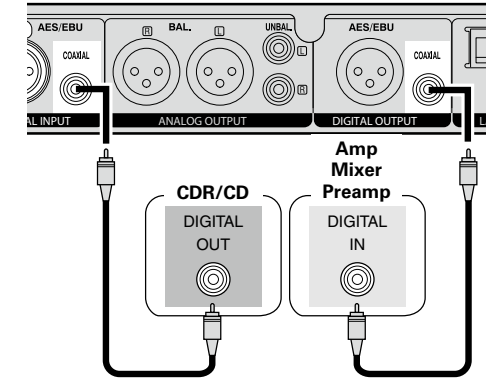

Digital connection (AES/EBU)

Connect digital inputs/outputs to the digital input/output (AES/EBU) connectors for playback or recording.

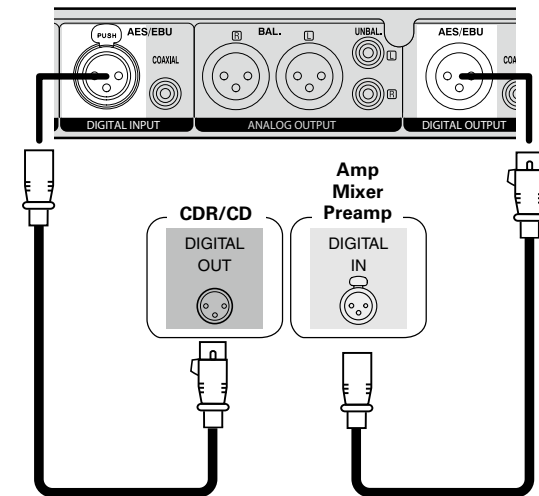

Connecting the microphone

Connect the XLR connector of a balanced microphone to the analog input (balanced).

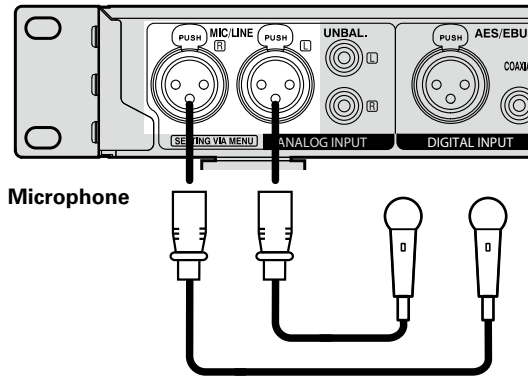

- Pin arrangement:
 1. Ground (GND)
 2. Hot (HOT)/Phantom power supply (+48V)
 3. Cold (COLD)
- Suitable connector: CANNON XLR-3-32 or equivalent



- Select "Mic" for the "08 Line/Mic Lch" and "09 Line/Mic Rch" (page 22) settings in "System Setting".
- Set the input sensitivity for each of the microphone left and right channels in the "12 Mic In Sens Lch" and "13 Mic In Sens Rch" (page 22) settings in "System Setting".
- Phantom power (+48V) can be turned On or Off per left and right channels in the "10 Phantom Lch" and "11 Phantom Rch" (page 22) settings in "System Setting".

NOTE

Turning phantom power On and connecting using a normal input may cause damage to this unit or the connected device. Be careful when configuring these settings and making connections.

Connecting the external control terminal

Parallel port

Connect the external device to the parallel port.

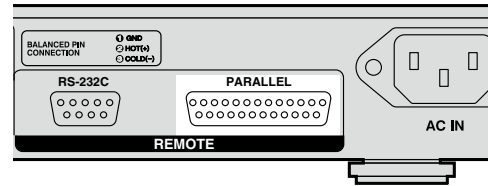

Parallel control can be used to control DN-700R from an external device.

For details on parallel control, see "Parallel control" (page 74).

RS-232C terminal

Connect an RS-232C straight cable with a 9-pin D-sub connector to the RS-232C serial terminal.

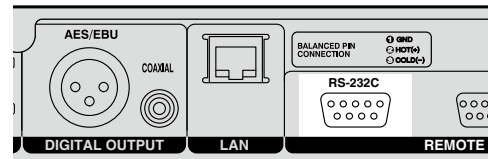

RS-232C control allows you to perform external control from the host. For details on RS-232C control, see "Serial remote control function" (page 71).

Connecting headphones

Connect the headphones to the headphone jack (PHONES).

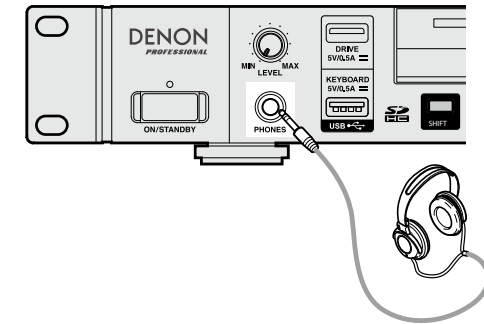

When you press the headphone volume adjustment knob (**LEVEL**), the knob will spring out. After adjusting the volume, press the knob back in again.

NOTE

To prevent hearing loss, do not raise the volume level excessively when using headphones.

Connecting the power cord

Insert the power cord when all other connections are completed.
Be sure to connect the ground wire also.

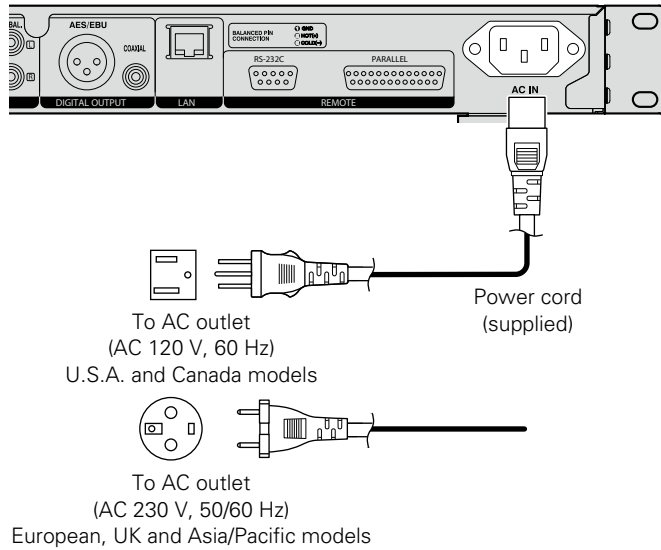

NOTE

- Be sure to insert the power plug firmly into the AC outlet. If the plug is not properly inserted, it could cause a malfunction or noise.
- Do not unplug the power cord while the unit is operating.
- Do not use a power cord other than the cord supplied with this unit.

Mounting recording media

SD card

Inserting an SD card

1 Open the SD card door in the direction indicated with the arrow.

The screen displays "SD* DOOR OPEN".
(* is the selected SD card slot number.)

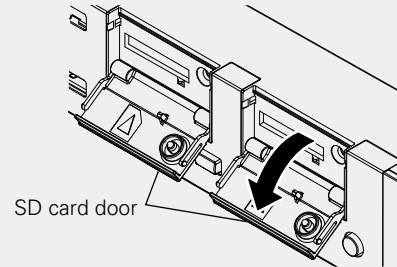

2 Insert the SD card fully into the SD card slot until a "click" sound is heard.

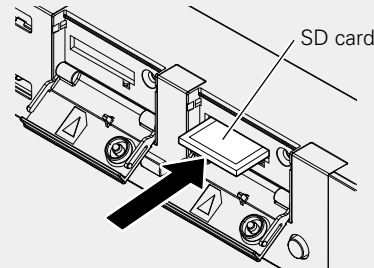

3 Close the SD card door.

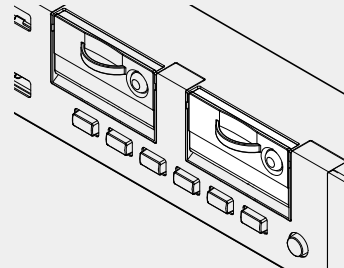

- If the SD card door does not close with a "click", check that the SD card is fully inserted into the slot.

Removing the SD Card

Check beforehand that playback from or recording to the SD card is stopped.

1 Open the SD card door in the direction indicated with the arrow.

The screen displays "SD* DOOR OPEN".

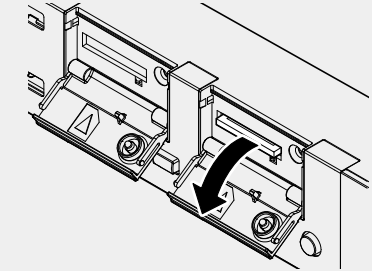

- The operation in progress continues even while "DOOR OPEN" is displayed.
- To make "DOOR OPEN" disappear, close the SD card door or press the jog dial.

2 Press the SD card.

The SD card springs out. Remove the card.

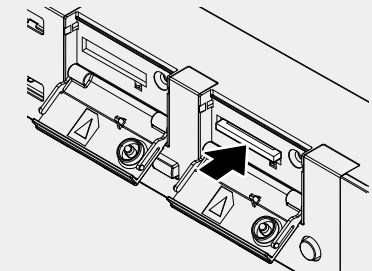

NOTE

Removing the SD card during recording may result in incorrect writing of the recorded file.

Do not remove the SD card during recording.

SD card protection

The DN-700R SD card door can be fixed in place using the SD card security screw included. (A small Phillips screwdriver is required for installation).

Fixing the SD card door prevents the door from being opened easily, thus preventing accidental loss of the SD card.

1 Remove the plastic pin and retainer.

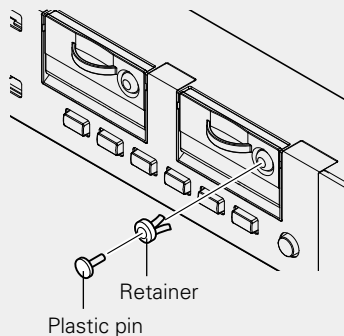

- Store the removed plastic pin and retainer in a safe place.

2 Attach the security screw to the screw hole from which the plastic pin was removed, and tighten it using a small Phillips screwdriver.

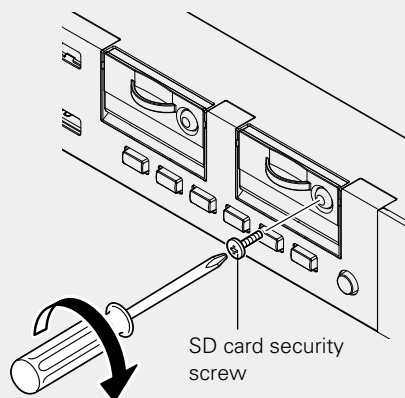

About SD card

For details of SD cards that have been confirmed as being compatible for use by DENON, see the DENON website (URL: <http://www.denon.com>).

Connecting a USB device

The DN-700R supports USB flash memory and external USB device (mass storage class).



- USB-HUBs are not supported.
- HFS+ is only supported for playback.
- FAT16/FAT32 file systems are supported.

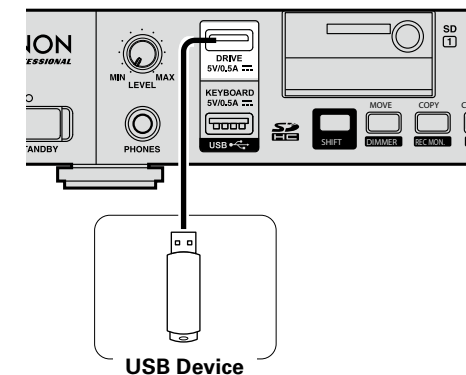

NOTE

Removing the USB drive during recording may result in incorrect writing of the recorded file.

Do not remove the USB drive during recording.

Cautions when recording media is mounted

- Do not use a cracked or warped SD card or USB drive, or one that has been repaired with adhesive.
- "Loading..." appears on the display when recording media is mounted or loaded. Do not remove the recording media while this message is displayed.

Setting defaults

Menu List

Setting button	MENU	Setting Item	Page
MENU	01 User Preset Sel	01 PRESET1	18
		02 PRESET2	
		03 PRESET3	
	02 Preset Setting X	01 Preset Title	18
		02 Shift Mode	18
		03 Power On	18
		04 Dual Rec	18
		05 Relay Rec	18
		06 Rec Level Type	18
		07 ALC	18
		08 One Touch Rec	18
		09 Audio Input	18
		10 Rec Format	18
		11 Rec Channel	18
		12 Sample Rate	18
		13 Pre Record	18
		14 Auto Track	18
		15 Auto Mark	19
		16 Silent Skip	19
		17 Silent Level	19
		18 Silent Time	19
		19 Play Range	19
		20 Play Mode	19
		21 Random	19
		22 Program	19
		23 Finish Mode	19
		24 Repeat	19
		25 Auto Cue	19
		26 Skip Back	19
		27 Search Mode	19
28 Auto Fade In	19		
29 Auto Fade Out	19		
30 Start Delay	20		

Setting button	MENU	Setting Item	Page		
MENU	02 Preset Setting X	31 End Of Message	20		
		32 Master Key	20		
		33 Time Display	20		
		34 File Sort	20		
		35 Dimmer	20		
		36 Display Dimmer	20		
		37 LED Dimmer	20		
		38 Screen Saver	20		
		39 Fader Start	20		
		40 Para Rem Mode	20		
		41 Keyboard Type	20		
		42 Default	20		
	03 Archive Setting	01 Archive Mode	54		
		02 Schedule *1	54		
		03 Server	01 IP Address	54	
			02 FTP User ID	54	
			03 FTP User Password	54	
			04 Folder	54	
		04 Clear After Arc	54		
		05 Auto Deletion	54		
		06 Connection Test	54		
		07 Default	54		
	04 Rec Timer	Rec Timer List (Max. 30)	Rec Timer Menu	Edit	35
				Insert	
				Clear	
				All Clear	
				Timer On	
	Timer Off				
	05 Play Timer	Play Timer List (Max. 30)	Play Timer Menu	Edit	45
				Insert	
Clear					
All Clear					
Timer On					
Timer Off					

*1 Not displayed when "Archive Mode" is set to "Auto".

Setting button	MENU	Setting Item		Page	
MENU	06 Program List	Program List (Max. 99)	Program List Menu	Preview	43
				Insert	
				Remove	
				Remove All	
				Load	
				Save	
	07 Hot List	Hot List (Max. 20)	Hot List Menu	Preview	47
				Auto Mapping	
				Set	
				Remove	
				Remove All	
				Load	
	08 System Setting			Save	21
				01 Timer Priority	
				02 Rec Folder	
				03 Signal Pass Thru	
				04 User Area	
				05 File Name Form	
				06 Mono Play	
				07 Output Rate	
				08 Line/Mic Lch	
				09 Line/Mic Rch	
				10 Phantom Lch	
				11 Phantom Rch	
				12 Mic In Sens Lch	
				13 Mic In Sens Rch	
				14 Volume Input	
				15 Ref(XLR/RCA)	
16 Input Trim Lch					
17 Input Trim Rch					
18 Output Trim Lch					
19 Output Trim Rch					
20 Time Form					
21 Date Form					
22 Display Contrast					
23 Language					
24 Serial Bit Rate					
25 Machine Name					

Setting button	MENU	Setting Item	Page
MENU	08 System Setting	26 IP Address	22
		Subnet Mask *2	22
		Gateway *2	22
		DNS Server *2	22
		27 IP Control Port	23
		28 IP Control Auth	23
		29 Network Standby	23
		30 NTP	23
		31 Syslog	23
		32 Time Zone	23
		33 Daylight Saving	23
		34 Admin Passwd	23
		35 Operator Passwd	23
		36 Observer Passwd	23
	37 PrdMgr Detect	23	
	38 PrdMgr PowerCtrl	23	
	39 Auto Reboot	23	
	40 Default	23	
	09 Utility	01 Time/Date	25
		02 Load Setting	25
		03 Save Setting	25
		04 Firmware Version	26
		05 Network Status	26
		06 Format Media	26
		07 Speed Check	26

*2 Not displayed when "26 IP Address" is set to "Auto".

Setting defaults

DN-700R can record audio input on an SD card in the unit or to a USB drive.

DN-700R is equipped with various recording and playback settings so that you can use wide-ranging applications to record and play back.

DN-700R also allows you to program up to three preset settings. Use this feature to preset recording and playback setting patterns in advance, according to your purpose. You can switch the settings for a specific purpose by simply selecting the preset number.

When using this unit for the first time, be sure to set the clock before use. For details on how to set the clock, see "Time/Date" (☞ page 25).

Menu operations

(Preset selection/Preset setting/System setting)

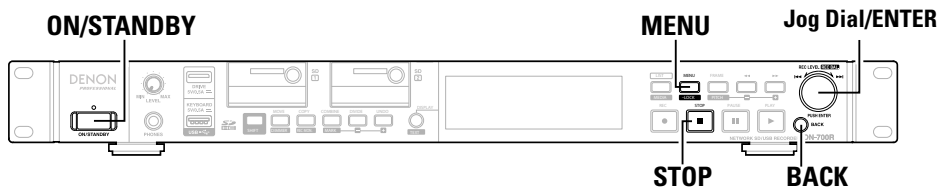

1 Press ON/STANDBY.

The power of DN-700R is switched ON, and the display screen lights.

2 While DN-700R is stopped, press MENU.

The menu list is displayed.

01 User Preset Sel
02 Preset Setting 1
03 Archive Setting
04 Rec Timer
05 Play Timer

• For details on the setting items in each menu, see "Menu List" (☞ page 15).

3 Rotate the jog dial to select the menu of the settings that you want to change, and press ENTER.

The menu list of the selected item is displayed.

- If an Admin password is set for "System Setting", the password needs to be entered.

4 Rotate the jog dial to select the setting item that you want to change, and press ENTER.

The setting item is chosen.

5 Rotate the jog dial to select the detailed item that you want to set, and press ENTER.

The setting item is chosen.

- To continue to set other items, perform the operation in step 4, 5 again.
- To return to the upper level menu from the menu item currently being set, press **BACK**.

6 After you finish all settings, press MENU.

The changed settings are saved, and DN-700R returns to the stopped status.

Canceling settings

Follow the steps below.

- ① Press **STOP**.
Displays the "Exit without Saving?".
- ② Rotate the jog dial to select "OK", and press **ENTER**.
The settings are canceled.

❑ Selecting presets (User Preset Sel)

Three presets (PRESET1/PRESET2/PRESET3) can be created.
Select and use the presets according to how the unit is used.



❑ Preset Setting

These settings are performed independently for each of the 3 presets (Preset-1/Preset-2/Preset-3). Firstly, select the preset number that you want to set from “01 Presets” in the menu.

- There are preset items that have different initial values for PRESET 1, 2 and 3. In this case, the PRESET number is recorded after the initial value.

Setting Items	Setting details (Items in bold are factory default)
01 Preset Title Changes the preset name.	Preset X (X=1 – 3)  For details, see “Renaming presets” (📖 page 21).
02 Shift Mode Sets operations for the SHIFT button.	Momentary: Switches to the shift mode when holding down the SHIFT button when another button is pressed. Lock: Switches to the shift mode when the SHIFT button is pressed. In this case, the SHIFT button lights.
03 Power On Sets the operation when the DN-700R power is switched on.	Stop: Stops when the power is switched on. Resume Play: Start playback from the track that was played last by the previous operation. Play First: Playback starts from the first track in the folder that was played last by the previous operation. Rec: Starts recording in the folder of the currently selected media. Settings for the save folder can be configured in “02 Rec Folder” (📖 page 21) in “System Setting”.
04 Dual Rec Sets the backup media for dual recording.	Off: Turns dual recording off. SD1: Selects SD1 as the backup media. SD2: Selects SD2 as the backup media. USB: Selects USB as the backup media.
05 Relay Rec Sets the media (secondary media) on which recording continues when relay recording is used.	Off: Turns relay recording off. SD1: Selects SD1 as the secondary media. SD2: Selects SD2 as the secondary media. USB: Selects USB as the secondary media.
06 Rec Level Type Sets the jog dial as the selection method for the recording level.	Master/Bal: Adjusts the input level and balance of the left and right channels. Separate L/R: Adjusts the input level of the left and right channels individually.

Setting Items	Setting details (Items in bold are factory default)
07 ALC Sets ALC (Auto Level Control).	Off (PRESET1/2): Turns ALC off. Mix: Sets the same ALC for the left and right channels. Separate (PRESET3): Sets ALC for the left and right channels individually.
08 One Touch Rec Sets the REC button operation.	Off (PRESET1/2): Press the REC button once to pause recording, and again to start recording. On (PRESET3): Press the REC button once to start recording.
09 Audio Input Selects the audio input source for recording.	Bal: Records the XLR analog input terminal source. UnBal: Records the RCA analog input terminal source. AES / EBU: Records the XLR digital input terminal source. Coaxial: Records the RCA digital input terminal source.
10 Rec Format Selects the audio format (MP3 or PCM) for recording.	MP3-320 (PRESET2) / MP3-256 / MP3-192 / MP3-128 (PRESET1) / MP3-64 / PCM-16 / PCM-24 (PRESET3) <ul style="list-style-type: none"> • Indicated bitrate values are those when you record as a stereo file. • Select the bitrate for the MP3 format. • Select the quantized bit number for the PCM format. • MP3 cannot be selected when the “12 Sample Rate” is 96k.
11 Rec Channel Select whether to record as a stereo file or a monaural file.	Stereo: Records as a stereo (2-channel) file. Mono(L): Records as a monaural (left channel) file. MonoMix: Mixes as stereo (2-channel) and records as a -3dB file.
12 Sample Rate Selects the sampling frequency for recording.	44.1k (PRESET1/2): Records at 44.1kHz. 48k: Records at 48kHz. 96k (PRESET3): Records at 96kHz. Ext (AES): Records with an external clock (AES/EBU). <p>NOTE</p> <p>This is only enabled for recording analog input. • 96k cannot be selected when the “10 Rec Format” is MP3.</p>
13 Pre Record When recording is started from the recording paused status, recording starts retroactively for this set amount of time.	Off: Turns pre recording off. 1sec / 2sec / 3sec / 4sec / 5sec
14 Auto Track Creates a new file for each recording time set and continues recording.	Off: Record without creating a new file. 1min / 5min / 10min / 15min / 30min / 1hour / 2hour / 6hour / 8hour / 12hour / 24hour <p>NOTE</p> <ul style="list-style-type: none"> • When the size of a recorded file reaches 2GB, recording automatically switches to a new file and continues. • There could be sound cutoffs for a short period of time between files depending on the capacity of a recorded file.

Setting Items	Setting details (Items in bold are factory default)
15 Auto Mark If an input that is below the level set in "17 Silent Level" continues for longer than the time set in "18 Silent Time" (page 19), marking information is written in the file. This mark is useful when searching for a specific point during playback.	Off: Turns the auto mark function off. On: Turns the auto mark function on.  <ul style="list-style-type: none"> • A maximum of 30 marks can be written to one file. • Marking numbers are attached in numerical order starting from 1. • Marks can also be added manually. For details, see "Add marks (marking)" (page 42). • Marks can be edited using the "DMP Mark Editor" software included. For details, see the instruction manual on the included CD-ROM.
16 Silent Skip If an input that is below the level set in "17 Silent Level" continues for longer than the time set in "18 Silent Time", recording is paused. Recording is restarted when input above the set level is received again.	Off: Turns the silent skip function off. On: Turns the silent skip function on. The S.S icon is shown on the display (page 38 "Silent skip recording").  <ul style="list-style-type: none"> • If the recording is temporarily stopped because of the silent skip function, "S.S" will flash on the display. • When "16 Silent Skip" is "On", a maximum 0.5 second pre recording is added before starting recording from the recording paused state.
17 Silent Level Sets the silent level when "15 Auto Mark" or "16 Silent Skip" is set to on.	-60dB / -54dB / -38dB / -20dB
18 Silent Time Set the silence judgment time for silent skip recording.	1sec / 2sec / 3sec / 4sec / 5sec
19 Play Range Sets the track playback range.	All: Plays back all of the tracks in all folders. Folder: Plays back all of the tracks in the selected folder. <div style="border: 1px solid black; border-radius: 10px; padding: 2px; display: inline-block; margin-top: 5px;">NOTE</div> "All" is only enabled for SD card and USB device playback. If "All" is selected for NET playback, this operates with the "Folder" setting.
20 Play Mode Sets the track playback mode.	Continuous: Continuously plays the tracks within the selected folder or within all folders (according to the "19 Play Range" setting). Single: Plays back only 1 track.

Setting Items	Setting details (Items in bold are factory default)
21 Random Sets random playback.	On: Random order playback is performed. Off: Random order playback is not performed.
22 Program Sets programmed playback.	On: Plays back tracks in the set order (programmed playback). Off: Programmed playback is not performed.
23 Finish Mode Sets the operation when playback is stopped.	Stop: Playback stops. Next: When playback is stopped, the next track is cued. Recue: Playback stops and returns to the cue point.
24 Repeat Sets repeat playback.	On: Repeat playback is performed. Off: Repeat playback is not performed.
25 Auto Cue Sets the auto cue function.	Off: Turns the auto cue function off. -48dB/-42dB/-36dB: After the track has been selected, audio in the beginning of the track that is below the set volume level is skipped and temporarily stops playback.  The auto cue function temporarily stops playback at the point where playback restarts after skipping the silent portion at the beginning of a file. <div style="border: 1px solid black; border-radius: 10px; padding: 2px; display: inline-block; margin-top: 5px;">NOTE</div> If the silent portion cannot be detected at the beginning of a file even after 20 seconds, then temporarily stops playback at the beginning of the file.
26 Skip Back The track skips back just the set amount of time during playback or when paused, and plays back or remains paused (page 41 "Skip back").	0.5 - 2 - 60sec: Set the skip back time for a track that is currently being played back to 0.5 second intervals between 0.5 and 10 seconds, or 5 second intervals between 10 and 60 seconds.
27 Search Mode Sets the search mode.	Normal: Plays back audio in 2 x speed search, but does not play back audio at faster playback speeds. Silent: Audio is not played back during search.
28 Auto Fade In Sets the fade in time at the start of playback.	Off: Does not function. 0.5 sec/1.0 sec/3.0 sec: The volume gradually increases for the set time.
29 Auto Fade Out Sets the fade out time when playback is stopped.	Off: Does not function. 0.5 sec/1.0 sec/3.0 sec: The volume gradually decreases for the set time.

Setting Items	Setting details (Items in bold are factory default)
30 Start Delay Sets the playback start timing.	Off: Does not function. (Playback starts immediately). 100ms / 200ms / 300ms: Playback starts after the set time.
31 End Of Message Sets how the EOM display lights in the display.	Off: Does not function. 0 sec: Flashes for 0.5 seconds when the track ends. 5 sec / 10 sec / 15 sec / 20 sec / 30 sec / 60 sec: Flashes for the set amount of time before the track ends.
32 Master Key Sets the master key for the pitch control function.	Off: Disabled. On: Enabled.
33 Time Display Sets how the playback and recording time are displayed.	HH:MM:SS: Displayed in hours/minutes/seconds. MMM:SS;FF: Displayed in minutes/seconds/frames.
34 File Sort Selects the sorting method of the file list order.	Name: Sorts files into order of symbols → numbers → alphabetical order. Date: Sorts files into date order. NOTE Sorting cannot be used when the media is "NET". Files are sorted in folder units.
35 Dimmer Turns the "36 Display Dimmer" and "37 LED Dimmer" settings on/off.	Off: Does not function. ON: Functions.
36 Display Dimmer Sets the brightness of the display.	100%: Normal brightness. 75%: 75 % of the normal brightness. 50%: 50 % of the normal brightness. 25%: 25 % of the normal brightness. 0%: Off in the standby status, and 25 % of the normal brightness during operation.
37 LED Dimmer Sets the LED brightness.	100%: Normal brightness. 75%: 75 % of the normal brightness. 50%: 50 % of the normal brightness. 25%: 25 % of the normal brightness.

Setting Items	Setting details (Items in bold are factory default)
38 Screen Saver Sets the screen saver.	Off: Does not function. On: The screen saver starts when there are no operations for 30 minutes.
39 Fader Start Sets the operations when parallel remote is used.	Play: Plays back while the FADER START pin of the parallel remote is closed. Play-Pause: Plays back while the FADER START pin is closed, and pauses when this pin is opened. Play-Next: Plays back while the FADER START pin is closed, and jumps to the next track when this pin is opened. Play&Lock: Plays back while the FADER START pin is closed, and locks the keys of the unit. Play&Lock-Pause: Plays back when the FADER START pin closes, and locks the keys of the unit. Playback pauses when this pin opens. Play&Lock-Next: Plays back when the FADER START pin closes, and locks the keys of the unit. Playback jumps to the next track when this pin opens. StartPause: During recording or playback, recording or playback starts when FADER START is closed, and recording or playback is paused when FADER START is opened. StartPauseTrack: During recording, Recording starts when FADER START is closed and is paused when FADER START is opened. Furthermore, if FADER START is closed again when recording is paused, the file is updated to a new file and recording restarts. ManualTrack: If FADER START is closed when recording is paused, the file is updated to a new file and recording continues.  For details on parallel remote, see "Parallel control" (page 74).
40 Para Rem Mode Sets the operating mode of the parallel remote function.	Hot Start: Sets the Hot Start mode. Hot Cue: Sets the Hot Cue mode (Playback is not performed by Hot Start).
41 Keyboard Type Sets the language type of the keyboard connected to the DN-700R.	US(English)/UK(English)/FR(French)/GE(German)/IT(Italian)/SP(Spanish)/DU(Dutch) / SW(Swedish) / JP(Japanese)
42 Default	Resets all of the preset settings to the defaults.

Renaming presets

Preset names can be renamed according to their use. A maximum of 32 characters can be input.

Entering Characters

First, select the preset number that you want to rename from "01 User Preset Sel" in the menu. Next, select "01 Preset Title" in "02 Preset Setting".

- Place the cursor in the position where you want to insert characters using the ◀▶ buttons.



- Rotate the jog dial to select the character you want to enter, and press **ENTER**.
- Repeat steps ① and ② or step ② to enter all of the characters.
- When you have finished entering the characters, press **ENTER**.
 - Saves the entered characters.

Deleting Characters





- Place the cursor to the right of the character you want to delete the ◀▶ buttons.
- Press **FRAME**.
 - Deletes a character on the left of the cursor.



- By default, presets have a name that is eight characters long. To rename an existing name, delete the currently set characters first and then enter a new name.
 - The following characters and symbols can be entered.
 A B C D E F G H I J K L M N O P Q R S T U V W X Y Z a b c d e f g h i j k l m n o p q r s t u v w x y z (space)
 # \$ % & ' () + , - ; = @ [] ^ _ ' { } ~ 0 1 2 3 4 5 6 7 8 9
 ¡ ¢ £ ¤ ¥ ¦ § ¨ © ª « ¬ ® ¯ ° ± ² ³ ´ µ ¶ · ¸ ¹ º » ¼ ½ ¾ ¿ À Á Â Ã Ä Å Æ Ç È É Ê Ë Ì Í Î Ï Ñ Ò Ó Ô Õ Ö × Ø Ù Ú Û Ü Ý Þ ß
 à á â ã ä å æ ç è é ê ë ì í î ï ð ñ ò ó ô õ ö ù ú û ü ý þ ÿ
- The characters on the above underlined part, from j to ÿ, are Latin alphabets. Alphabets are available when the display language is set to "Eng", but not available when it is set to "Jpn". For information about the display language, refer to "23 Language" (page 22).
- To cancel without saving the entered characters, press the **BACK** button before saving.
 - These characters can also be entered using a USB keyboard.

System Setting



Setting Items	Setting details (Items in bold are factory default)
01 Timer Priority Sets the priority of timer playback.	Off: Timer playback only starts in the standby, stop or cue state. On: Timer playback starts any time other than when recording.
02 Rec Folder Sets the folder where data is saved when recording.	Current: Recorded data is saved into the currently selected folder. Fixed: Recorded data is saved into a fixed folder directly below the root folder. A folder is automatically created if there is no folder. The folder name is "DMH_REC".  When "19 Play Range" (page 44) in "Preset Setting" is set to "All", data is saved to the root folder.
03 Signal Pass Thru Sets the input signal to the rear audio terminals when recording or when recording is paused.	Off: The input signal is not passed through to the rear audio terminals. On: The input signal is passed through unchanged to the rear audio terminals.  The input signal will always be present in the headphones regardless of the Signal Pass Thru setting.
04 User Area Sets the character string (user area) added to the recorded file name.	Off: User area is not used. On: User area is used.  For details on how to input the characters, see "Renaming presets" (page 21).
05 File Name Form Sets the file name creation format when recording.	MN_DT_UA: "Machine name_recording start time_user area.***" MN_UA_DT: "Machine name_user area_recording start time.***" DT_MN_UA: "Recording start time_machine name_user area.***" DT_UA_MN: "Recording start time_user area_machine name.***" UA_MN_DT: "User area_machine name_recording start time.***" UA_DT_MN: "User area_recording start time_machine name.***" (* is the extension.)
06 Mono Play Sets monaural playback.	Off: Channels are output in accordance with the input source. On: Channels are summed and output as monaural
07 Output Rate Sets the sampling rate of output audio.	Auto: Audio output based on the rate of the input media or file. 44.1k: Audio output at 44.1 kHz. 48k: Audio output at 48 kHz. Ext (AES): Uses an external clock (AES/EBU) to output audio.  When the external clock is 96kHz, audio is output according to the sampling rate of the playback file if the playback file has a sampling rate other than 96kHz.

Setting Items	Setting details (Items in bold are factory default)
08 Line/Mic Lch Sets the mode of the XLR left channel.	Line: Sets to line input. Mic: Sets to microphone input.
09 Line/Mic Rch Sets the mode of the XLR right channel.	Line: Sets to line input. Mic: Sets to microphone input.
10 Phantom Lch *1 Sets phantom power (+48V) for "08 Line/Mic Lch".	Off: Turns phantom power off for the left channel. On: Turns phantom power on for the left channel. However, when "08 Line/Mic Lch" is set to "Line", turn phantom power off.
11 Phantom Rch *1 Sets phantom power (+48V) for "09 Line/Mic Rch".	Off: Turns phantom power off for the right channel. On: Turns phantom power on for the right channel. However, when "08 Line/Mic Rch" is set to "Line", turn phantom power off.
12 Mic In Sens Lch Adjusts the XLR microphone sensitivity for the left channel in 0.1dBu increments.	-16dBu – -40dBu – -60dBu  When adjusting it, the sound is output to the output terminal.
13 Mic In Sens Rch Adjusts the XLR microphone sensitivity for the right channel in 0.1dBu increments.	-16dBu – -40dBu – -60dBu  When adjusting it, the sound is output to the output terminal.
14 Volume Input Sets the analog recording input level.	Fixed (0dB): Fixed at 0dB. Variable: Mute can be adjusted from -60 – 0 – 10dBu in 0.1dB increments.
15 Ref (XLR/RCA) Sets the input/output standard level.	+24dBu/+10dBV: XLR=+24dBu / RCA=+10dBV +20dBu/+6dBV: XLR=+20dBu / RCA=+6dBV +18dBu/+4dBV: XLR=+18dBu / RCA=+4dBV
16 Input Trim Lch Adjusts the analog input for the left channel in 0.1dB increments.	+2.0dB – 0dB – -2.0dB  When adjusting it, the sound is output to the output terminal.
17 Input Trim Rch Adjusts the analog input for the right channel in 0.1dB increments.	+2.0dB – 0dB – -2.0dB  When adjusting it, the sound is output to the output terminal.
18 Output Trim Lch Adjusts the analog output for the left channel in 0.1dB increments.	+2.0dB – 0dB – -2.0dB
19 Output Trim Rch Adjusts the analog output for the right channel in 0.1dB increments.	+2.0dB – 0dB – -2.0dB

Setting Items	Setting details (Items in bold are factory default)
20 Time Form Sets the type of the current time display.	12h: Switches to the 12-hour display (AM/PM). 24h: Switches to the 24-hour display.
21 Date Form Sets the display order of the date.	MDY: Displays the date in Month/Day/Year order. DMY: Displays the date in Day/Month/Year order. YMD: Displays the date in Year/Month/Day order.
22 Display Contrast Sets the contrast of the display.	1 – 5 : 1 is the darkest, 5 is the brightest.
23 Language *2 Selects the display language for the file names and folder names.	Eng: Displays the file names and folder names in English. Jpn: Displays the file names and folder names in Japanese.
24 Serial Bit Rate Sets the serial communication bitrate for RS-232C.	9600: 9600 bps 38400: 38400 bps
25 Machine Name *2 Displays the UPnP device name. (maximum 12 characters)	DN-700R
26 IP Address *2	Auto: DHCP is assigned automatically. Static: Specify a fixed IP address. When selected, the fixed address is displayed.
Subnet Mask *2	None: Not displayed when the "IP Address" is set to "Auto". Can be set for any setting other than "Auto". Static: 0.0.0.0 to 255.255.255.255 (When "Auto" is set: 255.255.255.0)
Gateway *2	None: Not displayed when the "IP Address" is set to "Auto". Can be set for any setting other than "Auto". Static: 0.0.0.0 to 255.255.255.255 (When "Auto" is set: 0.0.0.0)
DNS Server *2	None: Not displayed when the "IP Address" is set to "Auto". Can be set for any setting other than "Auto". Static: 0.0.0.0 to 255.255.255.255 (When "Auto" is set: 0.0.0.0)

*1 Settings are saved, and it takes approximately 8 seconds to switch the circuits in order to enable the settings. During this time "Saving" is displayed.

*2 The DN-700R will automatically reboot (power off and then back on) to enable the settings.

Setting Items	Setting details (Items in bold are factory default)
27 IP Control Port *2	0 to 65535 (23): Sets the IP control port number. Please note that port numbers 'xx' and 'xx' are not available as they are reserved for Web Remote and DLNA.
28 IP Control Auth *2	Off : Password authentication is not required for IP control. On : Password authentication is required for IP control.
29 Network Standby	Off : Only Front Sub u-Con operates (low power operation). On : Power is supplied to the network related circuits even in standby mode, and the unit can be controlled from the network.
30 NTP	Off : NTP is not used. On : NTP is used. Displays the NTP server address. Press ENTER to enter the address. Then select the cycle of NTP.
31 Syslog	Off : Event information is not sent to the server. On : Event information is sent to the server. The Syslog server address is displayed. Press ENTER to enter the address.
32 Time Zone Set the offset time in 15-minute units.	-12:00 – +14:00 (00:00)
33 Daylight Saving Sets daylight saving time.	Off : Daylight saving time is not applied. On : Daylight saving time is applied. Set the start and end date of daylight saving time and the offset time of up to six hours in 15-minute increments.
34 Admin Passwd Sets the Admin Password for when “Web Remote”, “IP Control” or “System Setting” are used.	****: Set the password between 6 to 12 characters.  For details on how to input the password, see “Renaming presets” (page 21).
35 Operator Passwd Sets the Operator Password for when “Web Remote” or “IP Control” are used.	****: Set the password between 6 to 12 characters.  For details on how to input the password, see “Renaming presets” (page 21).

Setting Items	Setting details (Items in bold are factory default)
36 Observer Passwd Sets the Observer Password for when “Web Remote” or “IP Control” are used.	****: Set the password between 6 to 12 characters.  For details on how to input the password, see “Renaming presets” (page 21).
37 PrdMgr Detect	On : Permits connection from Product Manager. Off : Does not permit connection from Product Manager. NOTE When set to off, connection cannot be made from DMR of DLNA.
38 PrdMgr Power Ctrl	On : Permits the unit power to be switched on/off from Product Manager. Off : Does not permit the unit power to be switched on/off from Product Manager.
39 Auto Reboot	Off : Does not automatically reboot. On : Reboots automatically if the main processor freezes.
40 Default	Resets all of the system settings to the defaults.

*2 The DN-700R will automatically reboot (power off and then back on) to enable the settings.

Menu Operations (Utility)

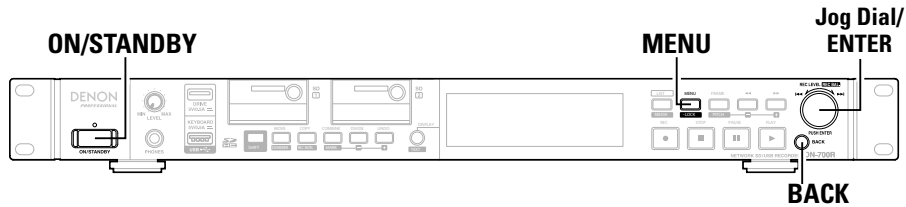

□ Select Utility

1 Press ON/STANDBY.
The power of DN-700R is switched ON, and the display screen lights.

2 While DN-700R is stopped, press MENU.
The menu list is displayed.

3 Rotate the jog dial to select “Utility”, and press ENTER.

- Press **BACK** to return to the previous item.
- Press **MENU** to exit the menu when the menu is displayed. The menu display turns off.

Saving the menu settings to an SD card or USB memory

This unit has a function for saving the menu settings to an SD card or USB flash memory. This function is useful for transferring the settings from one DN-700R onto other DN-700R units.



- Data that can be saved
 - Preset settings: PRESET1, PRESET2, PRESET3 data, currently used preset number
 - System setting
 - Recording timer setting
 - Playback timer setting
 - Playback pitch information, recording input level, recording monitor
 - Archive settings

NOTE

When “34 Admin Passwd” (page 23) is set in “System Setting”, the System Setting data is not applied if the password in the DN-700R is not the same.

Time/Date

- Set the current time. The time must be set before using the unit because the set time is used as the recorded file name.
- If the unit is connected to a network and “30 NTP” (☞ page 23) in “System Setting” is set to “On”, the current time settings do not need to be configured.

1 Select “Utility” and rotate the jog dial to select “Date/Time”, then press ENTER.**2 Rotate the jog dial to select the input position (year/month/day/hour/minute), and press ENTER.**

```
Date/Time
Date:May/13/2013
Time:11:54
T
</>: </> Change:JOG Push
```

3 Rotate the jog dial to select the setting item, and press ENTER.

- The current time display type (12-hour display/24-hour display) can be selected in “20 Time Form” (☞ page 22) in “System Setting”.
- The display order of the date (year/month/date) can be selected in “21 Date Form” (☞ page 22) in “System Setting”.

4 When all settings are entered they will be automatically saved and the utility menu will be displayed. If only some of the settings are changed, but not all, press BACK twice.

“Fix” and “Discard” are displayed.

5 Rotate the jog dial to select “Fix”, and press ENTER.

Confirm the settings.

- Select “Discard” to discard the changes.

Load Setting

Reads the preset setting file stored in the root directory of the currently used media (SD1/SD2/USB), and changes the settings of the unit accordingly.

1 Select “Utility” and rotate the jog dial to select “Load Setting”, then press ENTER.
Displays the “Load Preset?”.**2 Select “OK” with the jog dial, and press ENTER.**
The “DN-700R.ini” file on the currently used media is read, and the unit’s settings are updated. When the update is complete, “Completed” is displayed.**Save Setting**

Saves the current preset settings in the root directory of the currently used media (SD1/SD2/USB).

1 Select “Utility” and rotate the jog dial to select “Save Setting”, then press ENTER.
Displays the “Save Preset?”.**2 Select “OK” with the jog dial, and press ENTER.**
The “DN-700R.ini” file is saved in the root directory of the currently used media. When the update is complete, “Completed” is displayed.

- The file uses UTF8.

NOTE

This unit is equipped with a clock function, but the time may become skewed due to the installation condition of the unit.

When using the timer function, it is recommended to connect to a network and use NTP.

❑ Firmware Version

Displays the firmware version of the DN-700R.

Select “Utility” and rotate the jog dial to select “Firmware Version”, then press ENTER.

Displays the firmware version of the DN-700R.

❑ Format Media

Formats the currently used media (SD1/SD2/USB).

1 Select “Utility” and rotate the jog dial to select “Format Media”, then press ENTER.

The media list is displayed.

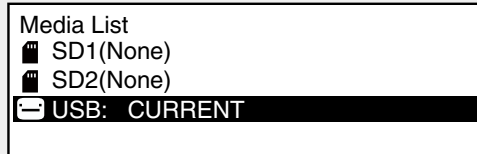

2 Rotate the jog dial to select the media, and press ENTER.

3 Select “OK” with the jog dial, and press ENTER.

“Formatting” is displayed during formatting, and “Completed” is displayed when the formatting is complete.

❑ Speed Check

Checks the read and write speed of the currently used media (SD1/SD2/USB).

Always perform a speed check on media before using it.

1 Select “Utility” and rotate the jog dial to select “Speed Check”, then press ENTER.

The media list is displayed.

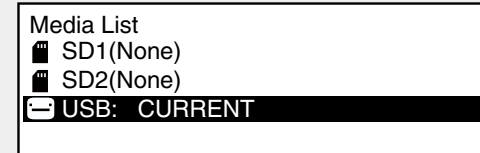

2 Rotate the jog dial to select the media, and press ENTER.

3 Select “OK” with the jog dial, and press ENTER.

Media check starts and “Check Speed ...” is displayed.

- The following results are displayed when the speed check is complete.
 - “Good”: The checked media is suitable for use.
 - “Good w/o Rec Mon”: The checked media is suitable for simple recording but is unsuitable for recording monitoring.
 - “Poor”: The checked media is unsuitable for use.

4 Select “OK” and press ENTER.

❑ Network Status

Displays network setting information.

Select “Utility” and rotate the jog dial to select “Network Status”, then press ENTER.

Network setting information (IP address/MAC address) is displayed.

Selecting Media

Media List

Media that can be selected are displayed in a list.

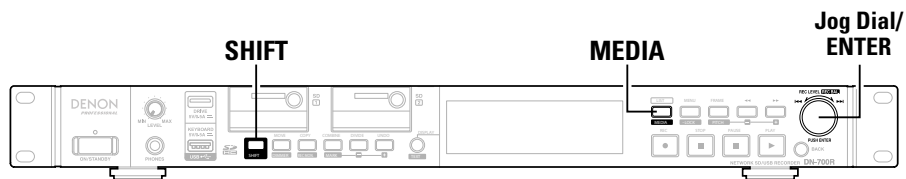

□ Displaying the media list and selecting media

- 1 When in the stopped state, hold down SHIFT and press MEDIA.**
The media list is displayed.

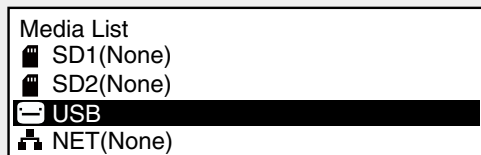

- “(None)” is displayed after the media name for media that is not ready to playback.
CURRENT: The currently selected media.
DUAL: Media set as backup media in “04 Dual Rec” (page 18) of “Preset Setting”.
RELAY: Media set as secondary media in “05 Relay Rec” (page 18) of “Preset Setting”.

- 2 Rotate the jog dial to select the media, and press ENTER.**
The selected media becomes the currently selected media, and the unit returns to the stopped state.

Media Server List

Media servers or PCs on the same network that the DN-700R is connected to that can be played back are displayed.

□ Displaying the media server list and selecting a media server

- 1 When in the stopped state, hold down SHIFT and press MEDIA.**
The media list is displayed.
- 2 Rotate the jog dial to select “NET”, and press ENTER.**
Displays the “Media Server List”.

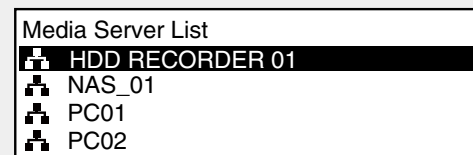

- 3 Rotate the jog dial to select the media server or PC to playback, and press ENTER.**

- For details on how to select files, see “File List” (page 28).

NOTE

- When playing back from a media server, playback operates using the “Folder” setting even if “19 Play Range” (page 19) in “Preset Setting” is set to “All”.
- Data cannot be recorded to a media server or PC on the network.
- The following restrictions apply to files and folders on the network.
 - Files cannot be deleted/divided/merged and folders cannot be created/moved/deleted.
 - File names/folder names cannot be changed.
 - Files cannot be moved from the network to media connected to the unit.
 - Folders cannot be copied from media connected to the unit to the network.

Selecting Files and Folders

File List

The list of folders and files that can be selected is displayed.

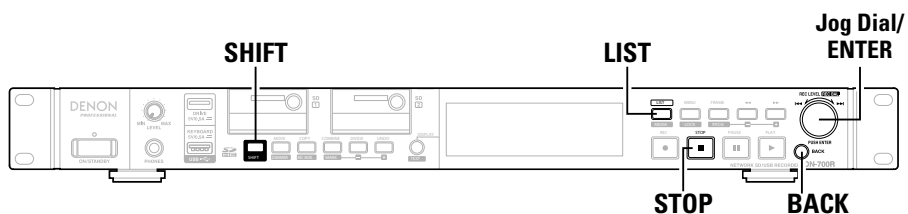

File List Menu

Perform file management operations. You can check file information, change file names, and delete, copy and move files.

□ Selecting folders and files and displaying the file list menu

- 1 Press **LIST** when the playback screen is displayed.
The "File List" is displayed.

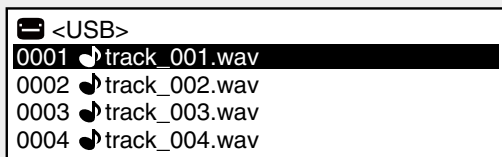

□ Folder selection

- Use the jog dial to select "<Up One Level>" for the parent folder and press **ENTER** to display the file list in the folder one level above.
- Use the jog dial to select the folder and press **ENTER** to display the file list in the selected folder.
- Press **LIST** to exit folder selection and return to the stopped status.

□ File selection

- Use the jog dial to select a file and press **ENTER** to close the file list and cue the start of the selected file.

- 2 Rotate the jog dial to select the file or folder to operate, and press **MENU**.

The File List Menu is displayed.

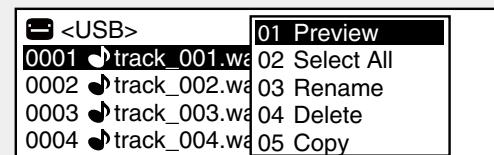

- Press **BACK** in the file list menu display to return to the previous screen.

□ File List Menu

Display	Explanation
01 Preview	Previews just one track of the selected file.
02 Select All	Selects all files in the list.
03 Rename*	Changes the file name or folder name.
04 Delete	Deletes selected files or folders.
05 Copy*	Copies selected files or folders.
06 Move*	Moves selected files or folders.
07 Make Folder	Creates a new folder.
08 Delete Mark	Deletes all marks from the selected file.
09 Property	Displays information of the selected file.

*: Directly after editing, "UNDO" (page 49) can be used to return the edit to the previous state.

Playing back files (01 Preview)

Playback starts to preview the selected file.

Rotate the jog dial to select “01 Preview”, and press ENTER.

- Press **STOP** or **ENTER** to stop playback and return to the file list menu.

Selecting all files for copying/moving/deleting (02 Select All)

Use to select all files to copy, move or delete. Selects or deselects all files in the file list.

Rotate the jog dial to select “02 Select All”, and press ENTER.

- All files are selected and the display returns to the file list. Check marks are added to the front of the files.
- If all files were selected, this deselects all files.



If the folder is changed, the selected state is cleared.

Selecting multiple files to copy, move or delete

Use to select multiple files to copy, move or delete.

In the file list, hold down SHIFT and press ENTER.

- The file or folder on the cursor is selected and a check mark is added in front of it.
- Only files within the same folder can be selected.
- To deselect a file or folder, perform the selection operation again.



When the folder was changed, the selected state is cleared.

Changing the file name or folder name (03 Rename)

Change the name of the selected file.
Up to 252 characters can be entered.

1 Select “03 Rename” in the folder list menu, and press ENTER.

The rename menu is displayed.

File Rename

Track_001.wav

</>: <</> BKSP:FRAME IN:JOG

2 Change the file name or folder name.

- The method for renaming the file is the same as “Renaming presets” (page 21).

3 Press ENTER to save the changes.

- To return to the previous screen without saving the changes, press **BACK**.



If a space is entered at the start or end of the file name or folder name, the space is deleted when the file name or folder name is saved.

Deleting Files and Folders (04 Delete)

Delete the selected file or folder.

Select “04 Delete” in the folder list menu, and press ENTER.

“Delete?” is displayed.

- Select “OK” with the **ENTER** to delete the file.
- Select “Cancel” and press **ENTER** to cancel the file deletion and return to the file list menu.

Copying Files and Folders (05 Copy)

Copy the selected file or folder to a different media or folder.

1 Select “05 Copy” in the folder list menu, and press **ENTER**.

A media list for selecting the copy destination is displayed.

2 Rotate the jog dial to select the copy destination media, and press **ENTER**.

The folder list is displayed.

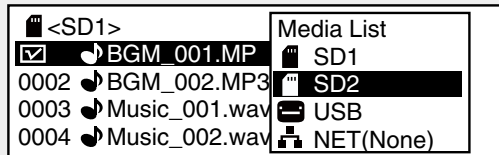

3 Rotate the jog dial to select “<Copy Here?>” in the copy destination folder level, and press **ENTER**.

The copy process starts.

- During copying, “Executing ... ***%” (*: progress status) is displayed.
- When the copying is complete, “Completed” is displayed.
- Select “Cancel” and press **ENTER** to cancel copying.

NOTE

Copying cannot be performed in the following situations.

- When the media is write prohibited
- When there is not enough free space on the media
- When there is same file name / folder name

Moving files (06 Move)

Move the selected file or folder to a different media or folder.

1 Select “06 Move” in the folder list menu, and press **ENTER**.

A media list for selecting the move destination is displayed.

2 Select the move destination media and press **ENTER**.

The folder list is displayed.

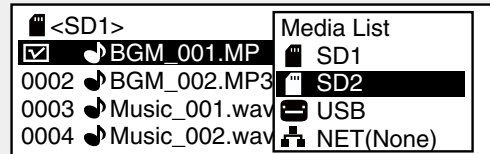

3 Rotate the jog dial to select “<Move Here?>” in the move destination folder level, and press **ENTER**.

The move process starts.

- During moving, “Executing ... ***%” (*: progress status) is displayed.
- When the moving is complete, “Completed” is displayed.
- Select “Cancel” and press **ENTER** to cancel moving.

NOTE

Files cannot be moved to other media in the following situations.

- When the media is write prohibited
- When there is not enough free space on the media
- When there is same file name / folder name

Creating folders (07 Make Folder)

Create a new folder in the selected folder.

1 Rotate the jog dial to select “07 Make Folder”, and press **ENTER**.

The name change menu is displayed.

Make Folder
New Folder
</>: </> BKSP:FRAME IN:JOG

2 Enter the folder name.

- For details on how to input, see “Renaming presets” (page 21).

3 Press **ENTER** to save the changes.

- Press **BACK** to return to the previous screen without saving the changes.



If a space is entered at the start or end of the folder name, the space is deleted when the folder name is saved.

Deleting marks (08 Delete Mark)

Deletes all of the marks written into the selected file.

Select “08 Delete Mark” in the folder list menu, and press **ENTER**.

“Delete Mark?” is displayed.

- Select “OK” with the **ENTER** to delete the marks.
- Select “Cancel” and press **ENTER** to cancel the mark deletion and return to the file list.

File information (09 Property)

The selected file information is displayed.

Rotate the jog dial to select “09 Property”, and press **ENTER**.

File information is displayed.

```
Property
track_001.wav
2013/04/23 0 :15AM
00:00:33 96kHz St 4608kbps
```

- Press **BACK** to return to the file list menu.

Other functions

Locking operation buttons (Key lock)

1 Hold down **SHIFT** and press **LOCK** for more than **1 second**.

Displays the “Keys Restricted”.
Buttons other than those shown below are locked.

- ❑ **Operation buttons that can be used**
SHIFT, LOCK, ON/STANDBY, PLAY, PAUSE, REC, MARK +/-, FRAME, <<<, >>>, |<<<, >>>|
 - Press and hold **ON/STANDBY** for more than 4 seconds to power off the unit.

2 Additionally, hold down **SHIFT** and press **LOCK** for more than **1 second**.

Displays the “All Keys Locked”.
Buttons other than those shown below are locked.

- ❑ **Operation buttons that can be used**
SHIFT, LOCK, ON/STANDBY
 - Press and hold **ON/STANDBY** for more than 4 seconds to power off the unit.

3 Additionally, hold down **SHIFT** and press **LOCK** for more than **1 second**.

Displays the “All Keys Unlocked”.
All keys are unlocked.

Recording

This section explains how to specify a recording media folder for a recording file and to record into that folder.

The procedure for recording to an SD card and a USB drive is the same.

Before using an SD card or USB device, use “Speed Check” (☞page 26) in the utilities to check that the SD card or USB device is suitable to use with this unit.

Selecting the recording media or folder for storing the recorded files

1 Press **ON/STANDBY**.

The power of DN-700R is switched ON, and the display screen lights.

2 When in the stopped state, hold down **SHIFT** and press **MEDIA**.

The media list is displayed.

3 Select media.

- For details on selecting the media list, see “Displaying the media list and selecting media” (☞page 27).

4 While DN-700R is stopped, press **LIST**.

The “File List” is displayed.

5 Select the folder.

- For details on selecting a folder, see “Selecting folders and files and displaying the file list menu” (☞page 28).
- When “Current” is selected in “02 Rec Folder” (☞page 21) in “System Setting”, the recorded file is stored in the selected folder. To store in a different folder, select a different folder. However, when “All” is selected in “19 Play Range” (☞page 19) in “Preset Setting”, files are stored in the root folder.
- When “Fix” is selected in “02 Rec Folder” in “System Setting” a fixed folder is automatically created directly below the root folder. The default folder name is “DMH_REC”.

NOTE

To record on an SD card, be sure to format it on DN-700R before recording. If the SD card is formatted on a computer or is used for recording without formatting it, this could result in sound cutoffs during recording. For details on the formatting procedure, see “Format Media” (☞page 26).

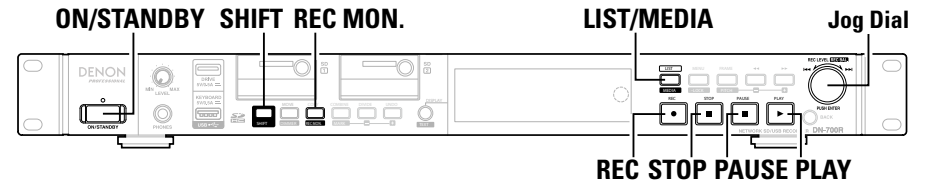

Recording

1 Press **REC**.

The unit switches to the recording paused state, and the **REC** buttons flashes and **PAUSE** buttons light. The display switches to the recording display.

- When “On” is selected in “08 One Touch Rec” (☞page 18) in “Preset Setting”, recording starts immediately when **REC** is pressed.
- The following results are displayed for media that cannot be recorded.
 - “No Format” for unformatted media or media with unsupported formatting
 - “Write Inhibited” for write protected media
 - “Media Full” if the recordable free space is less than 2MB
 - “Track Full” if the number of files exceeds 2000

2 Adjust the recording level and recording balance.

- To adjust the recording level and balance, select “Variable” in “14 Volume Input” (☞page 22) in “System Setting” in advance. Also, the input level can only be adjusted when “07 ALC” (☞page 18) is set to “OFF” and “09 Audio Input” (☞page 18) is set to “Bal” or “UnBal” in “Preset Setting”.
- There are two methods for level and balance adjustment. Select “06 Rec Level Type” (☞page 18) in “Preset Setting”.
 - **Master/Bal**
The input level can be adjusted using the jog dial. Also, hold down **SHIFT** to adjust the input level balance for the left and right channels using the jog dial.
 - **Separate L/R**
The input level of the left channel can be adjusted using the jog dial. Also, hold down **SHIFT** to adjust the input level balance for the right channel using the jog dial.

3 Press **REC**.

Recording starts.

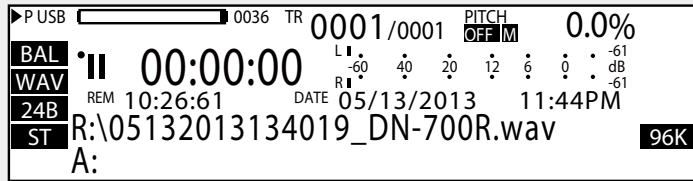

❑ Pre-recording

When the pre-recording time is set in "13 Pre Record" (page 18) in "Preset Setting", when recording is started, the recording starts retroactively for the set amount of time. If there is not more recording paused time that the pre-record set time, pre-recording cannot be done for the set amount of time.

❑ File name

The file name of the file in which recording is started is composed of the machine name, recording start time and user area data. The file creation formats can be selected in "05 File Name Form" (page 21) in "System Setting". The file name can be inputted when "04 User Area" (page 21) in "System Setting" is "On".

(After recording has started, the recording start time in the file name continues to proceed until the recording start time is confirmed.)

- You can adjust the recording level and balance even during recording.
- If the recordable space on the media falls below 2MB, recording stops.

4 Press **STOP**.

Recording stops, and **REC** turn off.

Recorded file information is displayed, and the display switches to the stop display. At this time, you can playback the recorded file by pressing **PLAY**.



If the directory in which the recording is saved is the root directly, the total number of folders and files is limited to 512 by FAT16 (8.3 file name) conditions.

To pause recording

Press **PAUSE** during recording.

- Recording is paused, **REC** buttons flashes **PAUSE** lights.
- Press **REC** again to resume recording on the same file.
- When "15 Auto Mark" (page 19) in the preset menu is set to "On", a mark is added at the point where the recording is resumed from the paused status.

Cautions on recording capacity

The amount of recording capacity required differs depending on the set recording format, number of recording channels, and sampling frequency.

To ensure that you do not run out of recording capacity during recording, check the recordable time in the "Recording time chart" (page 39) before starting recording.

Recording Monitor

The Record Monitor feature allows you to monitor the audio that has been recorded to the media.

Recording Monitor

- Press REC MON. in shift mode to switch the Recording Monitor on/off.
- When the Recording Monitor is on, the Recording monitor display (R.MON) lights. Data stored on the media is read from the media and monitored. You can preview the data to confirm it has recorded correctly onto the media.

Signal path through monitor

- This can monitor during recording pause and recording.
- When "03 Signal Pass Thru" (page 21) is set to "On" in "System Setting", the input signal selected in "09 Audio Input" (page 18) in "Preset Setting" is output. Monitoring is performed irrespective of whether the headphones setting is "on" or "off".

NOTE

- A delay occurs in the monitor against the input signal because recorded data is then read.
- The monitor may stop due to the type or condition of the used media because recording and playback are performed simultaneously.
- The recording monitor cannot be used during dual recording.

Dual recording

The selected media and backup media can be recorded simultaneously.

1 Select the media to record.

- For details on selecting the media, see "Displaying the media list and selecting media" (page 27).

2 Select the backup media.

- For details on selecting backup media, see "04 Dual Rec" (page 18) in "Preset Setting".
- Dual recording is given priority when both "04 Dual Rec" and "05 Relay Rec" are selected in "Preset Setting".

3 Start recording using the same operation as normal recording.

Recording starts simultaneously for the selected media and backup media.

- The file of BackUp Media is stored in the folder made with "21 Date Form" (page 22) in System Setting.
- During recording, if the free space is fully used in the selected media first, recording to both the selected media and backup media stops.
- During recording, if the free space is fully used in the backup media first, recording to the backup media stops but continues to the selected media.
- When the selected media and backup media are the same media, dual recording is canceled and normal recording starts.
- When the recording monitor is on, normal recording starts only for the selected media.

Relay recording

Data is recorded to the first selected media, and when the remaining space on that media falls below 2MB, recording stops on that media and starts on the secondary media (media for continual recording).

1 Select the media for current recording.

- For details on selecting the media list, see "Displaying the media list and selecting media" (page 27).

2 Select the secondary media.

- For details on selecting secondary media, see "05 Relay Rec" (page 18) in "Preset Setting".
- Dual recording is given priority when both "04 Dual Rec" and "05 Relay Rec" are selected in "Preset Setting".

3 Start recording using the same operation as normal recording.

Recording starts first on the selected media.

When recording is complete on the selected media, recording starts on the secondary media.

- When recording is complete on the secondary media, recording stops and relay recording is complete.
- When the selected media and backup media are the same media, relay recording is canceled and normal recording starts.
- The file of Relay Media is stored in the folder made with "21 Date Form" (page 22) in System Setting.

Timer Recording

- Recording is performed for the set amount of time from the specified time.
- The recording start time specification (schedule type) can be set as the day of week and time or date and time.
- A maximum of 30 recording timers can be set.

Recording timer list menu

Edit	Enters or edits the timer information.
Insert	Enters new timer information before the selected timer.
Clear	Deletes the selected timer information.
All Clear	Deletes all of the timer information.
Timer On	Turns the selected timer on.
Timer Off	Turns the selected timer off.

Timer recording start time and recording time settings

1 While DN-700R is stopped, press **MENU**.
The menu list is displayed.

2 Rotate the jog dial to select “Rec Timer”, and press **ENTER**.
Displays the recording timer list.

Rec Timer 01	M_W_F_ 15:30
Rec Timer 02	Apr/01/2013 12:01
Rec Timer 03	<Empty>
Rec Timer 04	<Empty>
Rec Timer 05	<Empty>

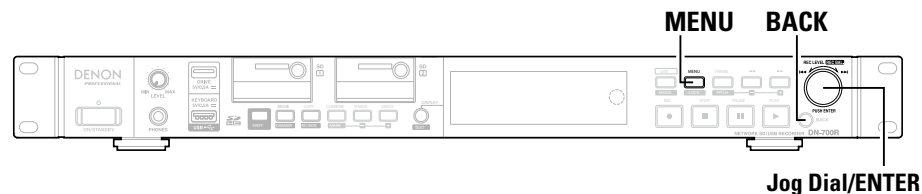

3 Rotate the jog dial to select “Empty”, and press **ENTER**.
Displays the recording timer list menu.

Rec Timer 01	Edit
Rec Timer 02	Insert
Rec Timer 03	Clear
Rec Timer 04	All Clear
Rec Timer 05	

4 Rotate the jog dial to select “Edit”, and press **ENTER**.
Displays the type of recording schedule.

5 Rotate the jog dial to select the type of schedule, and press **ENTER**.
Type types of recording start schedules are as follows.

- Day of Week: Specify the day and time.
- Date Time: Specify the date and time.

6 **When entering “Day of Week”**

- ① Rotate the jog dial to select the input position, and press **ENTER**.
- ② Rotate the jog dial to select the recording day, and press **ENTER**.
A check mark is added in front of the selected day.

Day Of Week	<input checked="" type="checkbox"/> Sunday
Week: S	<input type="checkbox"/> Monday
Time: 00:00	<input type="checkbox"/> Tuesday
T	<input type="checkbox"/> Wednesday
</>:</> Change: J	<input type="checkbox"/> Thursday

③ After selecting the day, rotate the jog dial to select “Exit”, and press **ENTER**.
The recording start schedule is fixed.

- Repeat this process to select more than one day.
- Select “All” to select all of the days.
- Selected days can be canceled by selecting them again.

6 □ When entering “Date Time”

-2

Date Time
Date:Jan/00/0000
Time:00:00

</>:<</>> Change:JOG Push

- ① Rotate the jog dial to select the input position, and press **ENTER**.
- ② Rotate the jog dial to select the “year”, and press **ENTER**.
- ③ Rotate the jog dial to select the “month”, and press **ENTER**.
- ④ Rotate the jog dial to select the “date”, and press **ENTER**.

The recording start schedule is fixed.

- The display order of the date (year/month/date) can be selected in “21 Date Form” (☞ page 22) in “System Setting”.

7 Rotate the jog dial to select the recording start time (hour/minute), and press **ENTER**.

The recording start time is fixed.

- The current time display type (12-hour display/24-hour display) setting can be selected in “20 Time Form” (☞ page 22) in “System Setting”.
- When “EveryHour” is selected, recording is performed every hour.

8 Rotate the jog dial to select the recording time (hours/minutes) and press **ENTER**.

The recording timer is displayed in the recording timer list when the recording timer input is completed.

- The recording timer can be set up to 99 hours 59 minutes.
- The timer switches on when the timer settings are complete.

9 Enter information to be stored in the user area.

- For character input, see “Renaming presets” (☞ page 21).

10 When all settings are entered they will be automatically saved and the utility menu will be displayed. If only some of the settings are changed, but not all, press **BACK** twice.

“Fix” and “Discard” are displayed.

11 Rotate the jog dial to select “Fix”, and press **ENTER**.

Confirm the settings.

- Select “Discard” to discard the changes.

Turning timer recording on/off**1** In the recording timer list, rotate the jog dial to select the recording timer that you want to turn on or off, and press **ENTER**.

Displays the recording timer list menu.

2 Rotate the jog dial to select “Timer On” or “Timer Off”, and press **ENTER**.

Displays the recording timer list.

Editing timer recording information

- 1** In the recording timer list, rotate the jog dial to select the recording timer that you want to edit, and press **ENTER**.

Displays the recording timer list menu.

- 2** **Changing the start time or end time of a selected recording timer**
Rotate the jog dial to select “Edit”, and press **ENTER**.

- For details on how to configure, see “Timer recording start time and recording time settings” (📖 page 35).

- 3** **Inserting a new recording timer in front of the selected recording timer**
Rotate the jog dial to select “Insert”, and press **ENTER**.

- For details on how to configure, see “Timer recording start time and recording time settings” (📖 page 35).
- If the number of recording timers exceeds 30, the last timer data is deleted.

- 4** **Deleting the selected recording timer**
① Rotate the jog dial to select “Clear”, and press **ENTER**.

Displays the “Clear?”.

- ②** Rotate the jog dial to select “OK”, and press **ENTER**.

The selected recording timer is deleted and the recording timer list is displayed.

- 5** **Deleting all recording timers**
① Rotate the jog dial to select “All Clear”, and press **ENTER**.

Displays the “All Clear?”.

- ②** Rotate the jog dial to select “OK”, and press **ENTER**.

All recording timers are deleted and the recording timer list is displayed.

- Press **BACK** to cancel editing.

Using timer recording

- Set the timer recording information and turn the timer on.
- Load a recording media to the current recording media.
- When the timer recording time is reached, recording starts with highest priority irrespective of the condition of the devices. However, the timer does not operate when the menu or file list, etc., is displayed.
- If the timer recording time is reached during recording, the recording file up to that point is created and a new timer recording is started.
- When the unit is in standby, the power turns on and recording starts.

Operations during recording

Add a file during recording (Manual track)

The manual track function divides tracks at the desired place during recording. Recording continues as a new file.

Press **DIVIDE** or **REC** during recording.

The file is cut at the point where the button is pressed, and recording continues in a new file.



Files can also be divided at a specified amount of time. For details, see "14 Auto Track" (page 18) in "Preset Setting".

NOTE

- There could be sound cutoffs for a short period of time between files depending on the capacity of a recorded file.
- If the size of a file being recorded reaches 2GB, recording is continued by automatically switching to a new file.
- The manual track function is not available for two seconds after starting recording.

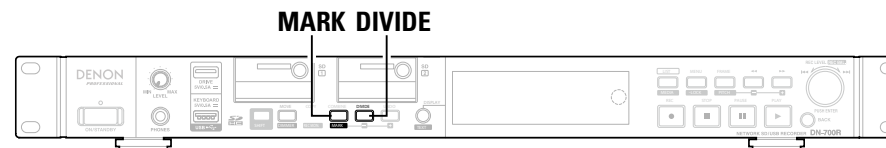

Adding marks (Marking)

By writing marking information to files, during playback you can search for marks and start playback from specific locations. By using this method, you can create specific search points within files without splitting files.

For details on how to search and playback from marks, see "Searching for Marks" (page 42).

Press **MARK**, in shift mode during recording.

A mark is added at the point where the button was pressed.



- A maximum of 30 marks can be written to one file.
- Marks can also be added automatically. For details on the settings, see "15 Auto Mark" (page 19) in "Preset Setting".
- Marks can be edited using the "DMP Mark Editor" software included. For details, see the instruction manual on the included CD-ROM.

Silent skip recording

When recording starts, silent sections during the recording can be detected and the recording paused during the silent sections.

1 Set "16 Silent Skip" (page 19) in "Preset Setting" to "On".
The **S.S** indicator lights.

2 Set the silence judgment level in "17 Silent Level" (page 19) in "Preset Setting".

3 Set the silence judgment time in "18 Silent Time" (page 19) in "Preset Setting".

- If the recording input level is at a level lower than that selected in "Silent Level" and continues for a length of time that exceeds the time selected in "Silent Time", recording to the media is paused and the **S.S** indicator flashes. Subsequently, when a recording input level that exceeds the level selected in "Silent Level" is detected, recording starts again. If "13 Pre Record" in "Preset Setting" is set at this time, the pre-recording function operates.
- If "15 Auto Mark" in "Preset Setting" is "On", a mark is recorded when the recording starts.

Recording time chart

All of the recording times are approximate times. Differences occur between recording media made by different manufacturers.

Recording time

Stereo file

Setting	Bitrate	Recordable time (Hours: Minutes)					
		1GB	2GB	4GB	8GB	16GB	32GB
PCM-24 (96kHz)	4608 kbps	0:30	0:59	1:59	3:57	7:54	15:48
PCM-24 (48kHz)	2304 kbps	0:59	1:59	3:57	7:54	15:48	31:36
PCM-24 (44.1kHz)	2117 kbps	1:04	2:09	4:18	8:36	17:12	34:24
PCM-16 (96kHz)	3072 kbps	0:44	1:29	2:58	5:56	11:51	23:42
PCM-16 (48kHz)	1536 kbps	1:29	2:58	5:56	11:51	23:42	47:24
PCM-16 (44.1kHz)	1411 kbps	1:37	3:13	6:27	12:54	25:48	51:36
MP3-320	320 kbps	7:07	14:13	28:27	56:56	113:47	227:33
MP3-256	256 kbps	8:53	17:47	35:33	71:07	142:13	284:27
MP3-192	192 kbps	11:51	23:42	47:24	94:49	189:38	379:16
MP3-128	128 kbps	17:47	35:33	71:07	142:13	284:27	568:53
MP3-64	64 kbps	35:33	71:07	142:13	284:27	568:53	1136:07

Monaural file

Setting	Bitrate	Recordable time (Hours: Minutes)					
		1GB	2GB	4GB	8GB	16GB	32GB
PCM-24 (96kHz)	2304 kbps	0:59	1:59	3:57	7:54	15:48	31:36
PCM-24 (48kHz)	1152 kbps	1:59	3:57	7:54	15:48	31:36	63:13
PCM-24 (44.1kHz)	1058 kbps	2:09	4:18	8:36	17:12	34:24	68:48
PCM-16 (96kHz)	1536 kbps	1:29	2:58	5:56	11:51	23:42	47:24
PCM-16 (48kHz)	768 kbps	2:58	5:56	11:51	23:42	47:24	94:49
PCM-16 (44.1kHz)	705 kbps	3:13	6:27	12:54	25:48	51:36	103:12
MP3-320	160 kbps	14:13	28:27	56:53	113:47	227:33	455:07
MP3-256	128 kbps	17:47	35:33	71:07	142:13	284:27	568:53
MP3-192	96 kbps	23:42	47:24	94:49	189:38	379:16	758:31
MP3-128	64 kbps	35:33	71:07	142:13	284:27	568:53	1137:47
MP3-64	32 kbps	71:07	142:13	284:27	568:53	1137:47	2275:33



If the recording conditions are the same, the recording time of a monaural file will be twice longer than the recording time of a stereo file.

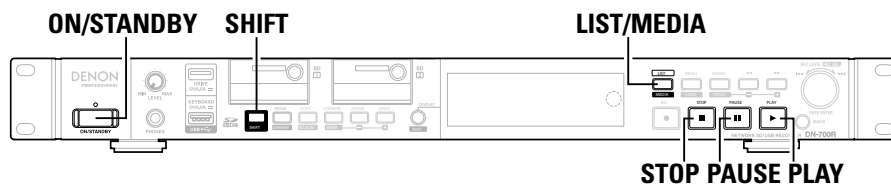

Selecting files to playback

1 Press ON/STANDBY.

The power of DN-700R is switched ON, and the display screen lights.

2 When in the stopped state, hold down SHIFT and press MEDIA.

The media list is displayed.

3 Select media.

• For details on selecting the media list, see “Displaying the media list and selecting media” (page 27).

4 While DN-700R is stopped, press LIST.

The “File List” is displayed.

5 Select a file.

The start of the selected track is cued.

• For details on selecting files, see “Selecting folders and files and displaying the file list menu” (page 28).

Playback

1 Press PLAY.

PLAY lights and playback starts.

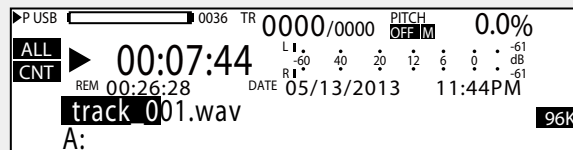

- Playback is performed according to the “19 Play Range” and “20 Play Mode” (page 19) settings in “Preset Setting”.
- When playback is complete, the setting of “23 Finish Mode” (page 19) in “Preset Setting” is applied.

2 To pause playback

Press PAUSE during playback.

Playback is paused and PAUSE lights.

- When PLAY is pressed again, playback is restarted.

3 To stop playback

Press STOP.

Playback stops, and PLAY goes out.

- The playback position is moved to the playback start position set for “23 Finish Mode” (page 19) in the preset menu and stops playback.
- Press STOP again to switch to the stopped state.
- The playback stop position varies as follows depending on the setting for “23 Finish Mode” in the preset menu.

When Next is set : When STOP is pressed during file playback, playback is stopped at the head (point B) of the next file.

When Recue is set : When STOP is pressed during file playback, playback is stopped at point where playback was previously started (point A).

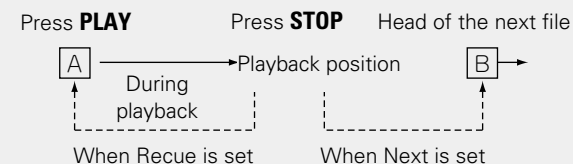

- This unit can play back VBR (Variable Bit Rate) format files.
- The remaining time display when VBR (Variable Bit Rate) format files are played back is an estimate.

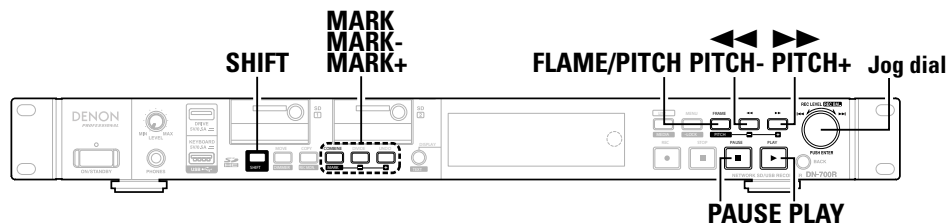

Rewind a specified amount of time and playback (Skip back)

During playback or pause, the track returns only the set amount of time from the playback position, and is then played back or paused from that position.

- This function can be controlled using Web Remote, parallel remote and serial remote.
- Set the time in “26 Skip Back” (page 19) in “Preset Setting”.

NOTE

- Skip back cannot be operated from the front panel buttons.
- Files recorded in VBR can not be skip back.

Changing files

Rotate the jog dial during playback or while stopped.

- Rotating in a clockwise direction switches to the next file.
- Rotating in the counterclockwise direction switches to the start of the current file, and then to previous files.

Exiting fast forward and fast rewind (search)

Press PLAY or PAUSE during search.

- When **PLAY** is pressed, playback continues from the position where search was exited.
- When **PAUSE** is pressed, playback is paused at the position where search was exited.

Fast forward and fast rewind (Search)

Press ◀◀ or ▶▶ during playback or in the stopped state.

- Press ◀◀ for fast rewind playback.
- Press ▶▶ for fast forward playback.
- The search speed changes each time the button is pressed.

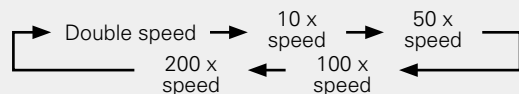

- Sound is not output at speeds above 2x.
- When “Silent” is selected in “27 Search Mode” (page 19) in “Preset Setting”, sound is not output at 2x speed or any speed above.
- When fast forward search is used to the end of the last file, or when fast rewind search is used to the start of the first file, the file pauses.

NOTE

- Search cannot be performed on files that are recorded using VBR.
- If a VBR file is found during the search process, the search ends at the VBR file.

Jumping by frames (Frame jump)

1 Press FRAME.

- Press **FRAME** during playback, cue or pause to switch to the Audible Pause state.
- **FRAME**, ◀◀ and ▶▶ light.

2 Either press ◀◀ or ▶▶, or rotate the jog dial.

- Pressing ◀◀ moves 1 frame in the reverse direction.
- Pressing ▶▶ moves 1 frame in the forward direction.
- When rotating the jog dial, one click moves one frame.

- Press **FRAME** to cancel frame search mode and return to the playback paused state.



1 frame is 1/75 seconds.

Playback pitch adjustment (Pitch control)

The playback speed can be adjusted within a range of -16 % to +16 %.

By adjusting the pitch, you can listen to recordings over a shorter time span, or listen more slowly to difficult to hear sections.

- 1 Press **PITCH** while holding down **SHIFT** during playback, cue or when stopped.
The pitch LED lights and pitch adjustment is enabled.

- 2 Press **PITCH +** or **PITCH -** while holding down **SHIFT**.

- The pitch changes by 0.1% each time the button is pressed.
- Press and hold the button to change the pitch continuously.
- To cancel the pitch control, press **PITCH** again while holding down the **SHIFT** button.

□ To change the pitch without altering the musical interval, use (master key).

When the playback speed is adjusted using the pitch control, the musical interval changes according to the playback speed.

When the master key function is on, the playback sound is played back without changing the musical interval even if the pitch is adjusted.

- For details on the key control settings, see “32 Master Key” (page 20) in “Preset Setting”.
- When “32 Master Key” is set to “On”, “**M**” appears in the display.

Add marks (marking)

By writing marking information in files, you can search for marks and play back from a certain point.

During playback or in the stopped state, hold down **SHIFT** and press **MARK**.

A mark is added at the point when you press it.

When a mark is added, “Mark *” (*: number of marks) is displayed.



- You can write up to 30 marks in a file.
- You can edit marks with the supplied software “DMP Mark Editor”. For more information, see the instruction manual for “DMP Mark Editor” on the supplied CD-ROM.

NOTE

- You cannot add marks to MP3 files that are not recorded by DN-700R.
- You cannot add marks when files are recorded in VBR.

Searching for Marks

During playback, cue or in the stopped state, hold down **SHIFT** and press **MARK +** or **MARK -**.

- When **MARK +** is pressed, the track is forwarded to the next marked point and paused.
- When **MARK -** is pressed, the system returns to the previous marked point and is paused.



Marks can only be searched within the current file.

Random playback

- 1 Set “21 Random” (page 19) in “Preset Setting” to “On”.
- 2 Press **PLAY**.
Tracks are selected at random and playback starts.

Program playback

- A maximum of 99 tracks can be registered to a program.
- The program can be saved to the media and can be read later.

Program list menu

Preview	Previews the selected file.
Insert	Enters a program. Or enters a new program in front of the selected program.
Remove	Deletes the selected program.
Remove All	Deletes all programs.
Load	Reads the programs on the selected media.
Save	Saves the programs on the selected media.

Create program

- 1 While DN-700R is stopped or in cue, press **MENU**.
The menu list is displayed.

- 2 Rotate the jog dial to select “Program List”, and press **ENTER**.
“Program List” is displayed.

```

Program List
01 BGM_002.MP3
02 Music_001.wav
03 <Empty>
    
```

- 3 Rotate the jog dial to select “<Empty>”, and press **ENTER**.
The “Program List Menu” is displayed.

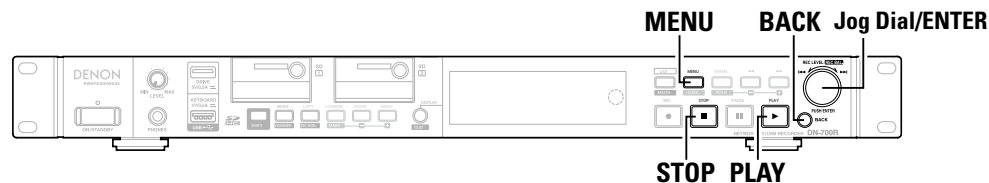

- 4 Rotate the jog dial to select “Insert”, and press **ENTER**.

The “File List” is displayed.

```

Program List
01 BGM_002.MP3
02 Music_001.wav
03 <Empty>
    
```

```

<SD1>
0001 BGM_001.MP3
0002 BGM_002.MP3
0003 Music_001.wav
0004 Music_002.wav
    
```

- 5 Rotate the jog dial to select the file you want to program, and press **ENTER**.

• Displays the “Execute”.

- For details on selecting files, see “Selecting folders and files and displaying the file list menu” (page 28).

- 6 Rotate the jog dial to select “Execute”, and press **ENTER**.

The program is entered.
“Program List” is displayed.

Previewing a file to be programmed

Rotate the jog dial to select “Preview”, and press **ENTER**.

- Preview playback of the selected file starts.
- Press **STOP** to exit playback and return to step 6.

- Repeat steps 3 to 6 to create a program list.

Previewing programmed files

- 1 Place the cursor on the programmed file in the program list menu, and press **ENTER**.
The “Program List Menu” is displayed.

- 2 Rotate the jog dial to select “Preview”, and press **ENTER**.

Preview playback of the selected file starts.

- Press **STOP** to end playback and return to the program list menu.

Program playback

1 Set “22 Program” (☞ page 19) in “Preset Setting” to “On”.

2 Press **PLAY**.
Tracks are played back in the created program order.

- If there are no program settings, tracks are played in normal playback.

☐ Relationship between program, play range and random settings (☞ page 44)

22 Program	21 Random	19 Play Range	Playback content
On	Off	–	Program playback in the set track order.
On	On	–	Random playback within the program.
Off	Off	All	Plays back all tracks in all sub folders from the root folder in the order set in “34 File Sort” (☞ page 20) of “Preset Setting”.
Off	On	All	Random playback within all files.
Off	Off	Folder	Plays back all tracks in the selected folder.
Off	On	Folder	Plays back all tracks in the selected folder in random order.

☐ Repeat playback

When “24 Repeat” (☞ page 19) is set to “On” in “Preset Setting”, repeat playback is performed in accordance with the relationship of the “19 Play Range”, “20 Play Mode”, “21 Random” and “22 Program” settings in “Preset Setting”.

Editing the program

- 1** ☐ **Inserting a new program in front of the selected program**
- ① **Rotate the jog dial in the program list and place the cursor on the program immediately after where you want to insert the program, and press ENTER.**
The “Program List Menu” is displayed.
 - ② **Rotate the jog dial to select “Insert”, and press ENTER.**
The “File List” is displayed.

- When the number of programs exceeds 99, the last program is deleted.

- 2** ☐ **Deleting the selected program file**
- ① **Rotate the jog dial in the program list and place the cursor on the program that you want to delete, and press ENTER.**
The “Program List Menu” is displayed.
 - ② **Rotate the jog dial to select “Remove”, and press ENTER.**
Displays the “Remove?”.
 - ③ **Rotate the jog dial to select “OK”, and press ENTER.**
The selected program file is deleted, and the “Program List” is displayed.

- 3** ☐ **Deleting all program files**
- ① **Press ENTER on the program list.**
The “Program List Menu” is displayed.
 - ② **Rotate the jog dial to select “Remove All”, and press ENTER.**
Displays the “Remove All?”.
 - ③ **Rotate the jog dial to select “OK”, and press ENTER.**
All program files are deleted, and the program list is displayed.

- Press **BACK** to cancel editing.

Saving/reading program data

- 1** ☐ **Saving the program to the selected media**
100 program lists can be saved.
- ① **Press ENTER on the program list.**
The “Program List Menu” is displayed.
 - ② **Rotate the jog dial to select “Save”, and press ENTER.**
 - ③ **Rotate the jog dial to select <Save Here?> on the folder in which you want to save the file, and press ENTER.**
Displays the “Save?”.
 - ④ **Rotate the jog dial to select “OK”, and press ENTER.**
Displays the text editor.
 - ⑤ **Enter the file name of the program to be saved, and press ENTER.**
The program is saved in the specified folder, and the “Program List” is displayed.
 - The saved file uses UTF8.

- For details on how to input, see “Renaming presets” (☞ page 21).

- 2** ☐ **Reading the program from the selected media**
- ① **Press ENTER on the program list.**
The “Program List Menu” is displayed.
 - ② **Rotate the jog dial to select “Load”, and press ENTER.**
Displays the “Misc List”.
 - ③ **Rotate the jog dial to select the file to read, and press ENTER.**
Displays the “Load?”.
 - ④ **Rotate the jog dial to select “OK”, and press ENTER.**
The read program is displayed in the program list.

Timer playback

- Playback is performed from the specified time for the set file.
- The playback start time specification (schedule type) can be set as the day of week and time or date and time.
- A maximum of 30 playback timers can be set.

□ Playback timer list menu

Edit	Enters or edits the timer information.
Insert	Enters new timer information before the selected timer.
Clear	Deletes the selected timer information.
All Clear	Deletes all of the timer information.
Timer On	Turns the selected timer on.
Timer Off	Turns the selected timer off.

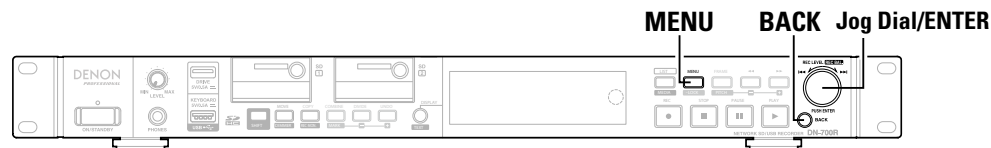

Timer playback start time and playback file settings

- 1 While DN-700R is stopped, press MENU.**
The menu list is displayed.
- 2 Rotate the jog dial to select “Play Timer”, and press ENTER.**
Displays the playback timer list.
- 3 “Timer recording start time and recording time settings” (page 35) operations 3 to 7 are performed.**
When the playback start time input is completed, the “File List” is displayed.
- 4 Rotate the jog dial to select the file you want to use for timer playback, and press ENTER.**
When the playback timer input is completed, the playback timer list is displayed.

- When the timer settings are complete, the set timer turns on.

Turning timer playback on/off

- 1 In the playback timer list, rotate the jog dial to select the playback timer that you want to turn on or off, and press ENTER.**
Displays the playback timer list menu.
- 2 Rotate the jog dial to select “Timer On” or “Timer Off”, and press ENTER.**
Displays the playback timer list.

Editing timer playback information

- 1** In the playback timer list, rotate the jog dial to select the playback timer that you want to edit, and press **ENTER**.

Displays the playback timer list menu.

- 2** **Changing the start time or end time of a selected playback timer**
Rotate the jog dial to select “Edit”, and press **ENTER**.

- For details on how to configure, see “Timer recording start time and recording time settings” (🔍 page 35).

- 3** **Inserting a new playback timer in front of the selected playback timer**
Rotate the jog dial to select “Insert”, and press **ENTER**.

- For details on how to configure, see “Timer recording start time and recording time settings” (🔍 page 35).
- The last timer data is deleted.

- 4** **Deleting the selected playback timer**
- ① Rotate the jog dial to select “Clear”, and press **ENTER**.

Displays the “Clear?”.

- ② Rotate the jog dial to select “OK”, and press **ENTER**.

The selected playback timer is deleted and the playback timer list is displayed.

- 5** **Deleting all playback timers**
- ① Rotate the jog dial to select “All Clear”, and press **ENTER**.

Displays the “All Clear?”.

- ② Rotate the jog dial to select “OK”, and press **ENTER**.

All playback timers are deleted and the playback timer list is displayed.

- Press **BACK** to cancel editing.

Using timer playback

- Set the timer playback information and turn the timer on.
- Load a timer playback media to the current playback media.
- The timer playback priority for when the playback start time is reached can be set in “01 Timer Priority” (🔍 page 21) in “System Setting”. However, the timer does not operate when the menu or file list, etc., is displayed or during recording.
- When the unit is in standby, the power turns on and playback starts.
- If other operations are performed during timer playback, timer playback is cancelled.

Hot Start

- The unit can be controlled from other devices using Web Remote, RC-F400S, parallel input and serial commands.
- When a button is pressed, this function instantly starts playback of a pre-selected file.
- Hot start can be set for 20 tracks.

Hot list menu

Preview	Previews the selected file.
Auto Mapping	20 tracks are automatically set to the hot list.
Set	Sets the hot list. Or re-sets the selected hot list.
Remove	Deletes the selected hot list.
Remove All	Deletes all hot lists.
Load	Reads the hot lists on the selected media.
Save	Saves the hot lists on the selected media.

Registering tracks to a hot list

1 While DN-700R is stopped or in cue, press **MENU**.
The menu list is displayed.

2 Rotate the jog dial to select “Hot List”, and press **ENTER**.
“Hot List” is displayed.

Hot List
01 BGM_002.MP3
02 Music_002.wav
03 <Empty>
04 <Empty>

3 Rotate the jog dial to select “<Empty>”, and press **ENTER**.
The “Hot List Menu” is displayed.

4 Rotate the jog dial to select “Set”, and press **ENTER**.
The “File List” is displayed.

Program List	<SD1>
01 BGM_002.MP3	0001 BGM_001.MP3
02 Music_001.wav	0002 BGM_002.MP3
03 <Empty>	0003 Music_001.wav
	0004 Music_002.wav

5 Rotate the jog dial to select the file you want to select for hot start, and press **ENTER**.
Displays “Preview” and “Execute”.

- For details on selecting files, see “Selecting folders and files and displaying the file list menu” (page 28).

6 Rotate the jog dial to select “Execute”, and press **ENTER**.
Hot start is entered.
“Hot List” is displayed.

Previewing a hot start file

Rotate the jog dial to select “Preview”, and press **ENTER**.

- Preview playback of the selected file starts.
- Press **STOP** to exit playback and return to step 6.

- Repeat steps 3 to 6 to create a hot list.

Automatically registering tracks to a hot list

1 Rotate the jog dial in the hot list menu to select “Auto Mapping”, and press **ENTER**.
A 20-track hot list is automatically registered.

- Files are registered in order from the first file in accordance with the “19 Play Range” (page 19) settings in “Preset Setting”.

Previewing files registered in the hot start list

1 Place the cursor on a hot start file in the hot start list, and press **ENTER**.
The “Hot List Menu” is displayed.

2 Rotate the jog dial to select “Preview”, and press **ENTER**.
Preview playback of the selected file starts.

- Press **STOP** to end playback and return to the hot start list.

Deleting a hot list file

1 **Deleting the selected hot list file**
• The operating method is the same as operation 2 of “Editing the program” (page 44).

2 **Deleting all hot list files**
• The operating method is the same as operation 3 of “Editing the program” (page 44).

Saving/reading hot list data

1 **Saving the hot list to the selected media**
• The operating method is the same as operation 1 of “Saving/reading program data” (page 44).
• 100 hot lists can be saved.

2 **Reading the hot list from the selected media**
• The operating method is the same as operation 2 of “Saving/reading program data” (page 44).

Edit Function

EDIT

Edit files.

COMBINE

Combine the selected file with another file on the same media to create a new file.

1 Press **COMBINE** when the combine source files are cued or paused.

The "File List" is displayed to select the combine target.

<USB>	<USB>
0001 track_001.wa	0001 track_001.wa
0002 track_002.wa	0002 track_002.wa
0003 track_003.wa	0003 track_003.wa
0004 track_004.wa	0004 track_004.wa

2 Rotate the jog dial to select the combine target file, and press **ENTER**.

Combining starts.

- The file name of the file created by combining source files is created according to the same rules as recording. For details, see "File name" (page 33).
- Files stored on other media cannot be combined.
- During combining, "Executing ... ***%" (*: progress status) is displayed.
- When the combination is complete, "Completed" is displayed.
- Select "Cancel" and press **ENTER** to cancel combining.

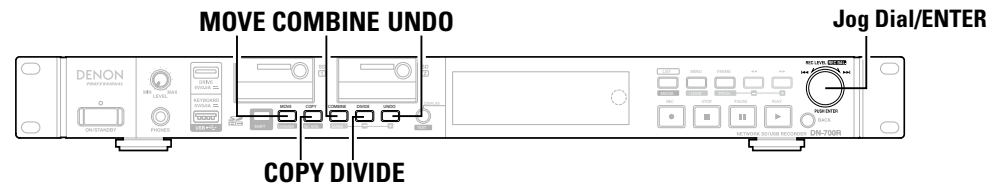

- The combined file is stored in the combination source folder.
- The files used in the combination remain unchanged.

NOTE

- Combining cannot be performed in the following situations.
- When the selected media is write prohibited
 - When there is not enough free space on the selected media
 - The maximum file size is 2GB
 - When the file format is a format other than WAV
 - When the total number of files reaches 2000
 - When the number of bits differs
 - When the number of channels differs
 - When the sampling rate differs

DIVIDE

The selected file is split into 2 files in the specified location.

1 Press **DIVIDE** during playback, cue or pause.

Displays "Divide?".

2 Rotate the jog dial to select "OK", and press **ENTER**.

Division starts.

- During the division, "Executing ... ***%" (*: progress status) is displayed.
- When the division is complete, "Completed" is displayed.
- Select "Cancel" and press **ENTER** to cancel the division.



- "_A" is added to the previous file name for the first part of the divided file. (Example: When aaa.mp3 is divided -> aaa_A.mp3)
- "_B" is added to the previous file name for the second part of the divided file. (Example: When aaa.mp3 is divided -> aaa_B.mp3)
- The original file used in the division remains unchanged.

NOTE

- Dividing cannot be performed in the following situations.
- When the selected media is write prohibited
 - At the start point or end point of a file
 - When the file format is a format other than WAV or MP3
 - When the number of files reaches 1999
 - When there is not enough free space on the selected media
 - When the file name after division already exists

COPY

Copies the selected file to a different folder or folder on a different media.

To copy multiple files, use “05 Copy” in the file list.

1 Press **COPY** when the file that you want to copy is stopped, cued or paused.

A media list for selecting the copy destination is displayed.

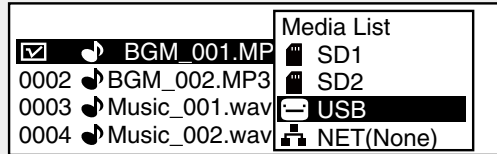

2 Rotate the jog dial to select the copy destination media, and press **ENTER**.

The folder list is displayed.

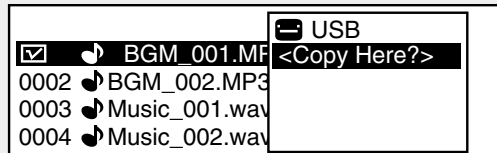

3 Rotate the jog dial to select “<Copy Here?>” in the copy destination folder level, and press **ENTER**.

Copying starts.

- During copying, “Executing ... ***%” (*: progress status) is displayed.
- When the copying is complete, “Completed” is displayed.
- Select “Cancel” and press **ENTER** to cancel copying.

NOTE

Copying cannot be performed in the following situations.

- When the media is write prohibited
- When there is not enough free space on the media

MOVE

Moves the selected file to a folder on the same or different media. To move multiple files, use “06 Move” in the file list.

1 Press **MOVE** when the file that you want to move is stopped, cued or paused.

A media list for selecting the move destination is displayed.

2 Select the move destination media and press **ENTER**.

- The folder list is displayed.

3 Rotate the jog dial to select “<Move Here?>” in the move destination folder level, and press **ENTER**.

Moving starts.

- During moving, “Executing ... ***%” (*: progress status) is displayed.
- When the moving is complete, “Completed” is displayed.
- Select “Cancel” and press **ENTER** to cancel moving.

NOTE

Files cannot be moved to other media in the following situations.

- When the media is write prohibited
- When there is not enough free space on the media

UNDO

Returns the edit operation performed immediately prior to the previous state.

“UNDO” can be used on COMBINE, DIVIDE, COPY, MOVE and file and folder renaming operations.

1 Press **UNDO** directly after the edit.

Displays “Undo?”.

2 Rotate the jog dial to select “OK”, and press **ENTER**.

When the operation is complete, “Completed” is displayed.

NOTE

When the edit is cancelled using “UNDO”, the file cannot be returned to it's previous state.

Control Function

USB Keyboard

This unit can be controlled using a keyboard by connecting a USB keyboard to the keyboard USB connector on this unit.

Keyboard key	Unit operation button
ESC	STOP (during Play, Rec etc.) BACK (during MENUs)
SHIFT + ESC	STOP (during MENUs)
ENTER	JOG ENTER
ARROW U /D /L /R	L /R: TRACK SKIP (during STOP/CUE/PLAY/SEARCH/ AUDIBLE PAUSE) U /D: REC LEVEL (Master / Lch by PRESETRec Level Type) (during REC /REC PAUSE) U /D /L /R: JOG (Rotate) (during Not CUE)
SHIFT+ARROW U /D	REC LEVEL (Balance / Rch by PRESETRec Level Type) (during REC /REC PAUSE)
PAGE UP /DOWN	PAGE UP /DOWN
BACK SPACE	SKIP BACK (during Pause or Play)
HOME	File list Top (During File list)
DELETE	DELETE CHARACTER
.	FRAME
/	PITCH
SPACE	PLAY / PAUSE (Toggle) SPACE (during TEXT editing)

Keyboard key	Unit operation button
Other PRINTABLE CHAR	CHARACTER
F1	DISPLAY
F2	FILE LIST
F3	PITCH -
F4	PITCH +
F5	LOCK
F6	RWD
F7	FWD
F8	MARK -
F9	MARK +
F10	MARK
F11	REC
F12	MENU
SHIFT + F1	TEXT
SHIFT + F2	RENAME CURRENT FILE (during CUE)
SHIFT + F3	DELETE CURRENT FILE (during CUE)
SHIFT + F4	COPY
SHIFT + F5	MOVE
SHIFT + F6	DELETE MARKS FROM CURRENT FILE (during CUE)
SHIFT + F7	COMBINE
SHIFT + F8	DIVIDE
SHIFT + F9	UNDO
SHIFT + F10	DIMMER
SHIFT + F11	REC MON
SHIFT + F12	MEDIA

NOTE

- Only keyboards that confirm to USB standards can be used with this unit.
- Before using a USB keyboard, set the language type in "41 Keyboard Type" (page 20) in "Preset Setting".

Connecting to a network (LAN)

You can connect this unit to your network (LAN) to perform various types of playback and operations as follows. Make network connections for this unit by carefully reading information on this page.

- Streaming playback of tracks from a media server on the network
- Control of the DN-700R via the network
- Archive function that sends files to a server via the network (☞ page 53)



When "29 Network Standby" (☞ page 23) in "System Setting" is set to "On", the network can be used to control the unit from the standby status.

Network settings need to be configured after the network (LAN) is connected. For details, see "Network Settings" (☞ page 52).

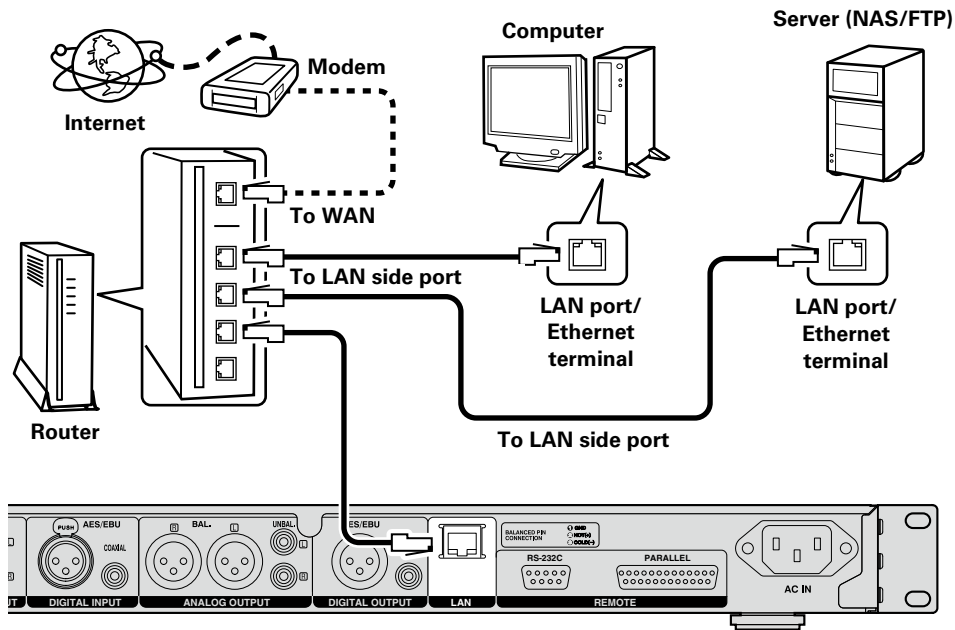

Required system

☐ Ethernet cable (CAT-5 or greater recommended)

- Use only a shielded STP or ScTP LAN cable which is available at retailer.
- The normal shielded-type Ethernet cable is recommended. If a flat-type cable or unshielded-type cable is used, other devices could be affected by noise.



- When using this unit connected to a network with no DHCP function, make the settings for the IP address, etc., at "System Setting" (☞ page 21).
- When setting manually, check the setting contents with the network administrator.

NOTE

DENON Professional assumes no responsibility whatsoever for any communication errors or troubles resulting from customer's network environment or connected devices.

Network Settings

LAN Connection

When connected to a network that has a DHCP function, settings for the DN-700R such as the IP address are configured automatically. When connected to a network that does not have a DHCP function, you need to configure settings such as the IP address and DNS server in “System Setting” (☞ page 21) in the menu.

NOTE

When configuring the network settings manually, contact your network administrator for the necessary setting details.

☐ Network connection (DHCP=Off)

1 Connect the Ethernet cable.
(☞ page 51 “Connecting to a network (LAN)”)

2 Turn the DN-700R power on.
(☞ page 17 “Setting defaults”)

3 Press **MENU**.
The menu list is displayed.

4 Rotate the jog dial to select “System Setting”, and press **ENTER**.

5 Set the “IP Address” to “Static”.
The currently set IP Address is displayed.
• Specify the appropriate IP address for your network.

6 Select the character using the jog dial and **Search+**, **Search-**, press **ENTER**.

- Use **Search+**, **Search-** to move the cursor.
- Press **FRAME** to delete the previously entered number.
- Press **BACK** to cancel the settings.

7 Press **ENTER** when you have finished entering the numbers.
The screen returns to the “System Setting” screen.

8 In the same way, enter the “Subnet Mask”, “Gateway” and “DNS Server” addresses.

9 When the “IP Address”, “Subnet Mask”, “Gateway” and “DNS Server” settings are complete, press the **MENU** button.
The DN-700R restarts automatically, and a pop up appears.

Archive

Backup function that sends recorded files of the current media to the FTP server. Also, long recording is possible by deleting recorded files from the current media automatically.

Menu operations (archive)

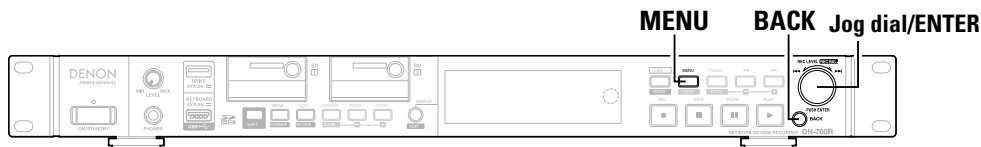

1 While DN-700R is stopped, press MENU.
The menu list is displayed.

2 Rotate the jog dial to select “Archive Setting”, and press ENTER.
The archive setting items are displayed.

3 Rotate the jog dial to select the item that you want to change, and press ENTER.

- For details on how to set the menu, see steps 4 to 6 in “Menu operations (Preset selection/Preset setting/System setting)” (☞ page 17).
- For details on how to set the “Schedule”, see steps 6 to 7 in “Timer recording start time and recording time settings” (☞ page 35).
- For details on how to set the “Server”, see step 6 in “Network Settings” (☞ page 52).

Archive Operation

- When archiving is started, “Now Archiving...” is displayed.
- When archiving is complete, “Archive Completed” is displayed. Parentheses “()” are added to the musical note icon of the completed file list files. When “Clear After Arc.” is “On”, the files are deleted after being archived.
- Media that supports archiving: SD or USB
- Archiving is not performed in the following conditions even if archive is set to “Auto” or “Timed”.
 - During playback
 - When the recording monitor is operating during recording
 - During dual recording
 - During WAV recording with a 96kHz sampling rate
 - When the selected media is write prohibited
 - When the menu screen is being displayed
- The file name character code in the archive function supports shift JIS.

□ Archive Setting

Item	Setting Details (Items in bold are factory default)
Archive Mode	<p>Off: No archiving. Auto: Recorded files are automatically archived when recording is complete. Timed: Recorded files are archived according to a set schedule when recording is complete.</p>
Schedule Sets the schedule to archive. Displayed when "Timed" is selected for "Archive Mode".	<p>Day Of Week: Sets the day and time (hours, minutes). DateTime: Sets the date and time (year, month, date, hours, minutes).</p>
Server Sets the IP and credentials of the FTP server.	<p>0.0.0.0 to 255.255.255.255 (default setting is 0.0.0.0). User ID: Input the user ID for the computer/server which will contain the archived files.</p> <p>NOTE If the user is part of a domain then input domain\user name.</p> <p>Password: Input the password for the user name.</p> <p>NOTE Alpha-numeric characters are excepted along with most special characters.</p> <p>Folder: Select the folder to archive to the server.</p>
Clear After Arc. Set to automatically delete the files after archiving is complete.	<p>Off: Files are not deleted after archiving is complete. On: Files are automatically deleted after archiving is complete.</p>
Auto Deletion When in the stopped state, archived files are deleted in order from the oldest onwards when the free recording space on the media is less than the set time.	<p>Off: No files will be deleted. 24h: Archived files are deleted when the recording free space is less than 24 hours. 12h: Archived files are deleted when the recording free space is less than 12 hours. 6h: Archived files are deleted when the recording free space is less than 6 hours. 3h: Archived files are deleted when the recording free space is less than 3 hours. 1h: Archived files are deleted when the recording free space is less than 1 hours.</p>
Connection Test	Performs a communication test with the FTP server.
Default	Initializes the setting details for archiving.

Other Functions (Product Manager)

DENON Professional Product Manager (hereinafter Product Manager) is an application that allows you to control DENON products from a PC or MAC.

- When “37 PrdMgr Detect” (page 23) in “System Setting” is “On”, connection with the unit is permitted.

[Main Functions]

1. Searches the network for DENON products that can be controlled.
2. When the icon or product information of the target product is clicked, the web browser opens and connects to the target product.

[Compatible Operating Systems]

- Microsoft Windows (Windows XP SP3 or later)
- Mac OS X (OS 10.7 or later)

[Compatible Web Browsers]

- Microsoft Internet Explorer Ver.9 or later (Windows)
- Google Chrome 21 for Windows or later (Windows)
- Mozilla Firefox18 for Windows or later
- Safari 5 or later (Mac OS X)

Installation of Product Manager

1 Insert the provided CD-ROM into the PC disc drive.

2 Click “Product Manager Install”.

The installation screen is displayed.

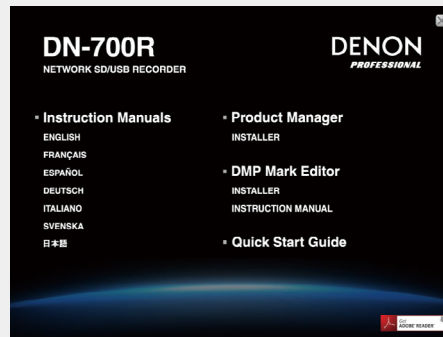

- If the installation screen is not displayed, open the disc drive in “My Computer”, open the “Installer” folder and double-click “SETUP.EXE”.

3 Read through the displayed cautions, and click “Next”.

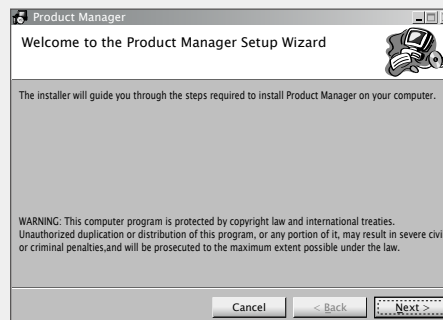

4 Specify the installation folder, select “Everyone” or “Just me” and click “Next”.

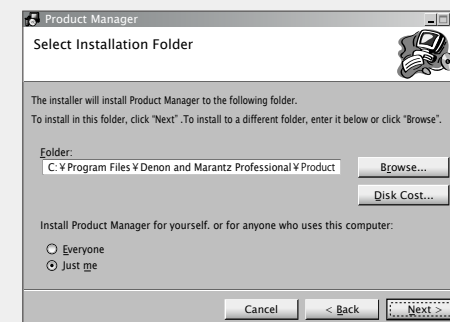

- Then click “Next” on the Confirm Installation dialog.

5 Read through the contents of the user license agreement, select “I Agree” and click “Next”.

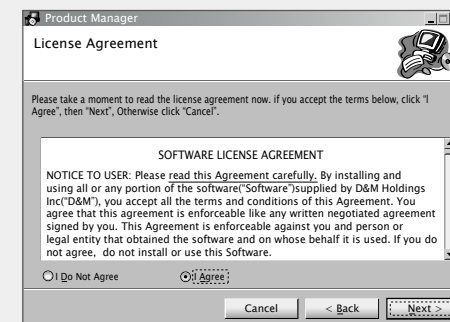

6 Installation starts.

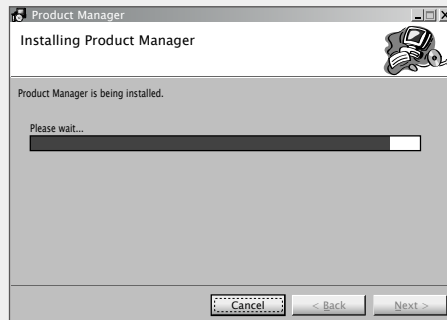

7 Click "Close" when the installation is completed.

The installation window closes.

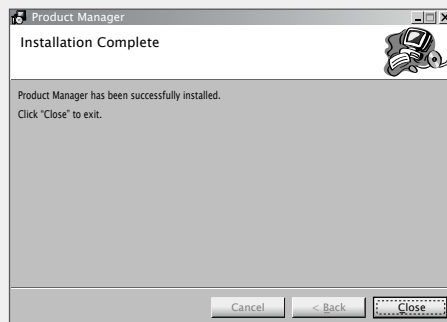

Product Manager window

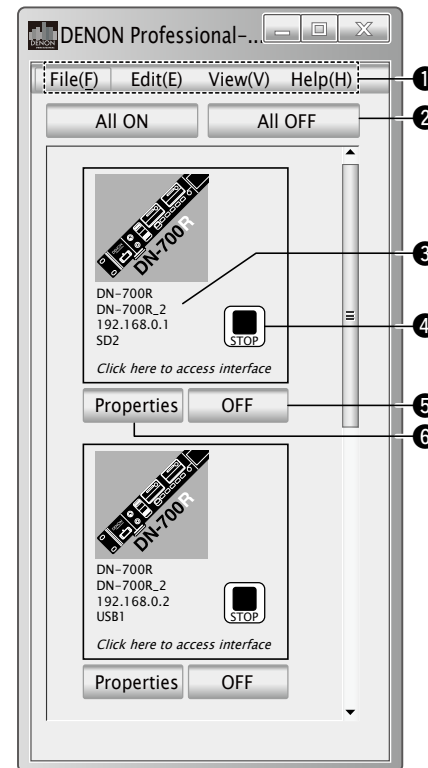

1 File menu, Edit menu, View menu, Help menu

2 Batch power ON/OFF button

The power can be switched ON/OFF for connected devices in the specified group units.

3 Product Information Display

Displays the network name, IP address, power status and currently selected source.

4 Transport Status Icon

Displayed when the power of the connected device is ON.

5 Individual power ON/OFF button

The power can be switched ON/OFF individually for connected devices.

6 Properties button

The window for configuring power control groups and batch power ON/OFF function settings is displayed.

Operations

❑ Password Settings

The first time Product Manager is launched, the password setup screen is displayed.

- Alphabetic characters (upper and lower case), numbers, hyphen and underscore can be used in the password.
- Set a password that is between 6 to 12 characters in length.
- Use "Setup Password" in the menu to reset passwords.

[Password Setting Screen]

❑ Password Input

When a password has been set, a password entry screen is displayed on the second and subsequent times the software is launched.

[Password Entry Screen]

Menu Item	Description
Quit	Quits the application.
Setup power sequence	Sets the timing between groups for the Power ON/OFF sequence group. Open the setting window to configure the settings.
Setup Password	The password setup screen appears and passwords can be setup.
Refresh	Updates the Device List and Window display.
Browser	Displays the web browser at the side of the Product Manager main window. The Control Screen (Web remote) is displayed when a DENON product is selected in the Product Manager window.
Version	The version of this application is displayed.

Properties Window

- Click the Properties button to display the window below and configure power control settings.

- Enabled when "38 PrdMgr Power Ctrl" (page 23) in "System Setting" is "On".

Setting window

The batch power ON and batch power OFF settings can be grouped, and intervals between the groups specified.

Select Menu - setup to open a different window for configuring settings.

Web Remote

The DN-700R is compatible with web browser applications. You can use the “Web Remote” application to control and configure settings for the DN-700R from your computer.

To connect to the DN-700R via web remote, launch a web browser and type the IP address of the DN-700R in the address bar.

❑ Password Screen

Launch the application and enter the password in the password screen to proceed to Web Remote. The password screen is displayed if a password is set in the preset menu (page 23 “34 Admin Passwd”). If a password is not set in the preset menu, the screen proceeds directly to the control screen.

- Alphabetic characters (upper and lower case), numbers and symbols can be used in the password.
- The password is between 6 to 12 characters in length.

1 Select the user name and enter the password in the “Password” text box (page 58 “User name and password”).

2 Click “GO”.

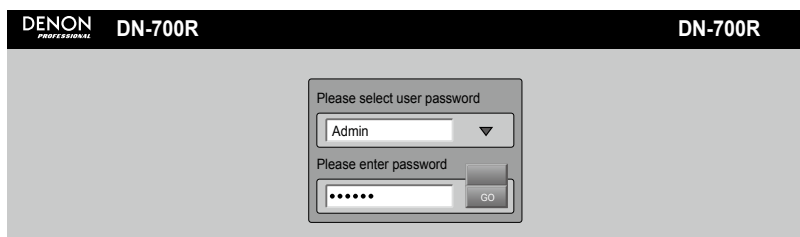

❑ User name and password

There are three types of user IDs, and the operating permissions differ depending on the ID. Passwords can be set for each of the user IDs in “System Setting” (page 21).

User ID	“Admin”	“Operator”	“Observer”
Password	34 Admin Passwd	35 Operator Passwd	36 Observer Passwd
View status and settings	Yes	Yes	Yes
Control operations	Yes	Yes	No
Hot Start operations	Yes	Yes	No
Preset Setting operations	Yes	Yes	No
Archive Setting operations	Yes	Yes	No
Rec Timer operations	Yes	Yes	No
Play Timer operations	Yes	Yes	No
Program operations	Yes	Yes	No
System Setting operations	Yes	No	No
Utility operations	Yes	Yes	No
Login user list	Yes	No	No

Main Frame Screen

This is the first screen displayed when Web Remote is launched.

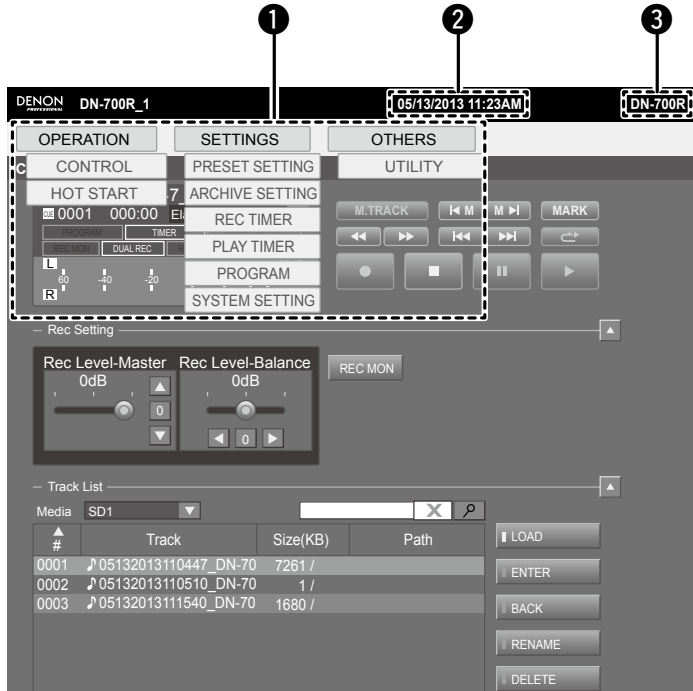

- 1 Screen Tab List
This is the screen list. Click the screen that you want to see to open it.
- 2 Time Information Display
Displays the current time originating from the device.
- 3 Model Name

Control screen (CONTROL)

- Displays the current track list.
- The time code display is updated every 0.1 to 0.3 seconds
- The Track List display periodically checks consistency with the DN-700R

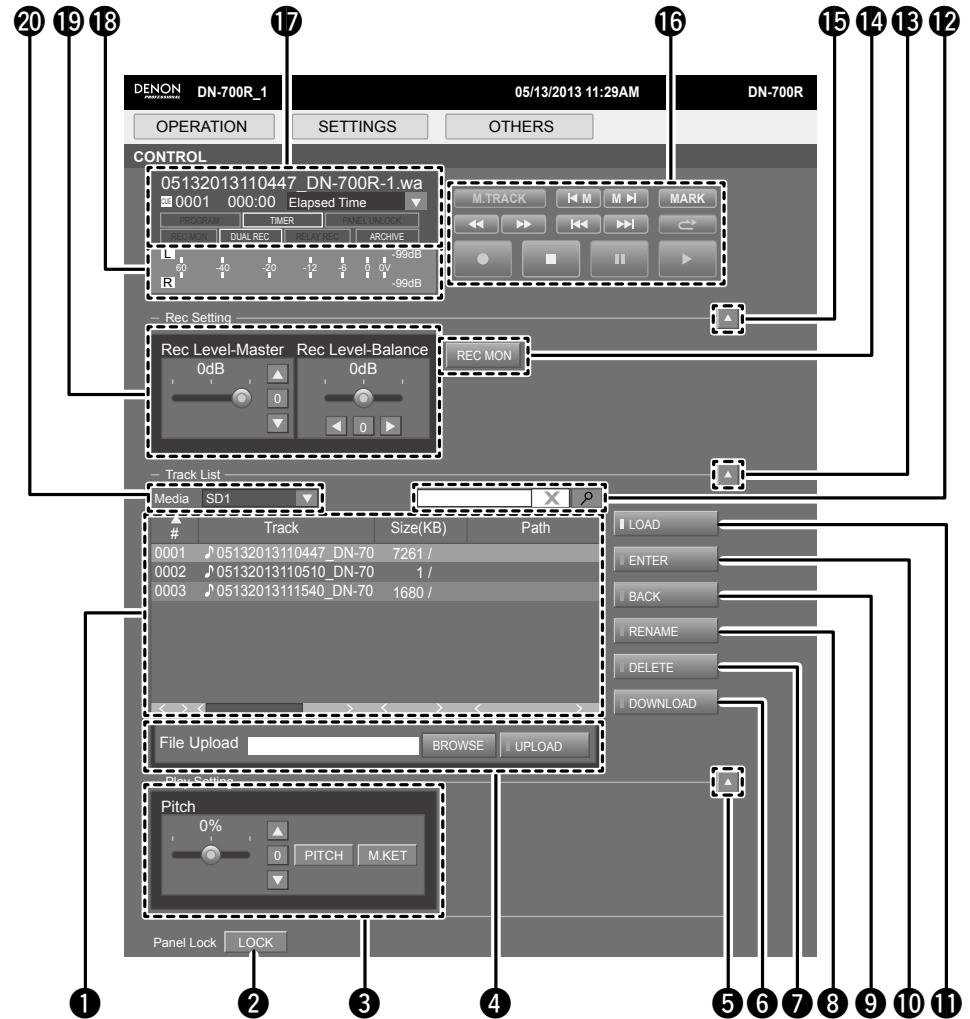

- 1 Track List
The DN-700R file list. The file name and size of MP3 and WAV data is displayed.
- 2 Panel Lock button
All buttons are locked other than Power, Lock and Shift.
- 3 Pitch adjustment
- 4 UPLOAD button
Uploads the folder selected as the sound file on the computer. When PlayRange in "Preset Setting" is All, data is uploaded to the root directory.
- 5, 13, 15 HIDE button
Hides items on the screen.
- 6 DOWNLOAD button
Downloads the selected file to the computer.
- 7 DELETE button
Deletes the file indicated by the cursor.
- 8 RENAME button
Enables the name of the file indicated by the cursor to be changed.
- 9 BACK button
Switches to the next higher level of the Track List Table.
- 10 ENTER button
Switches to the folder level of the Track List Table indicated by the cursor.
- 11 LOAD button
The file selected in the track list is loaded in the DN-700R.
- 12 Finder
Files can be searched by entering the file name.
- 14 REC MON Recording monitor button
- 16 Recording and playback control buttons
- 17 File data display, time display, settings display
- 18 Level meter
- 19 Recording input level settings, recording input Lch/Rch balance settings
- 20 Media select

File list screen

Press the [MAPPING] button on the hot start screen, [SELECT FILE] button on the playback timer screen or [INSERT FILE] button on the program screen to display the DN-700R file list and select files.

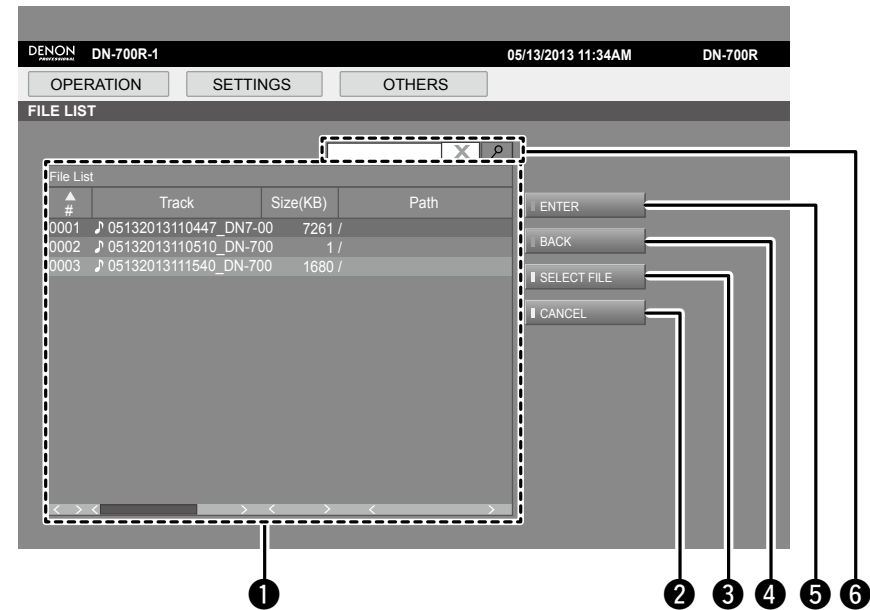

- 1 File List
- 2 Cancels the file selection operation.
- 3 SELECT FILE button
Returns to the program screen. The selected file is added to the program playback track list in the program screen, timer playback track list in the playback timer screen or hot start list in the hot start screen.
- 4 BACK button
Switches to the next higher level of the Track List Table.
- 5 ENTER button
Switches to the folder level of the Track List Table indicated by the cursor.
- 6 Finder
Files can be searched by entering the file name.

Program Screen (PROGRAM)

- Configure the program (List) settings (Maximum number of program files: 99)
- Changes can only be made when in the STOP mode.
- Files can be deleted and added to the program list
- Press the [Insert File] button to display the File List Screen and select tracks to insert.
- The files selected in [Insert File] is inserted one line above the selected line. (To insert a file last, select the EOL line.)
- For details, see "Program playback" (page 43).

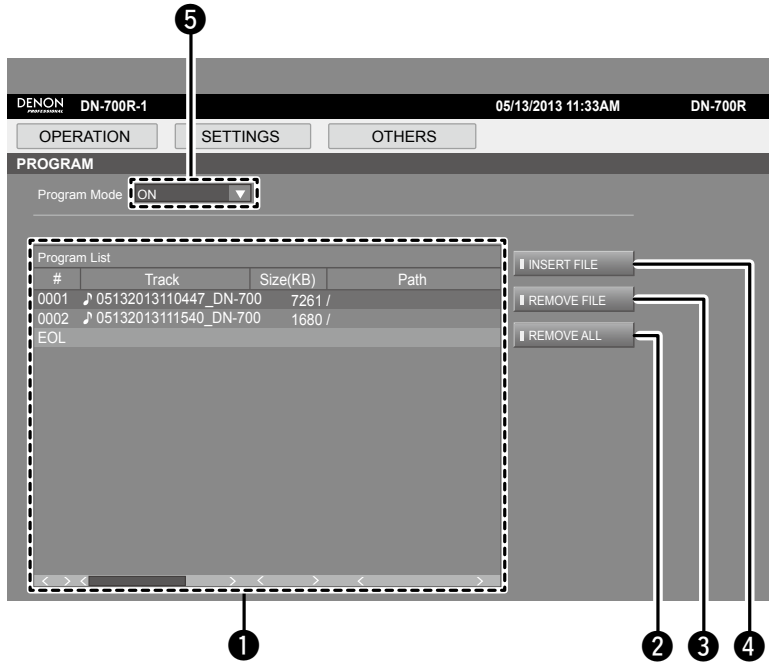

- 1 Program playback track list
- 2 REMOVE ALL button
Removes all files in program.
- 3 REMOVE FILE button
Deletes the selected line.
- 4 INSERT FILE button
Switches to the file list. Files selected in the file list are inserted above the line selected in the program playback track list.
- 5 Select program mode

Hot Start Screen (HOT START)

- Starts playback for Hot Start (Maximum number of registered files: 20)
- Press any of the buttons from [1] to [20] to start playback.
- The time code display is updated every 0.1 to 0.3 seconds
- For details, see "Hot Start" (page 47).

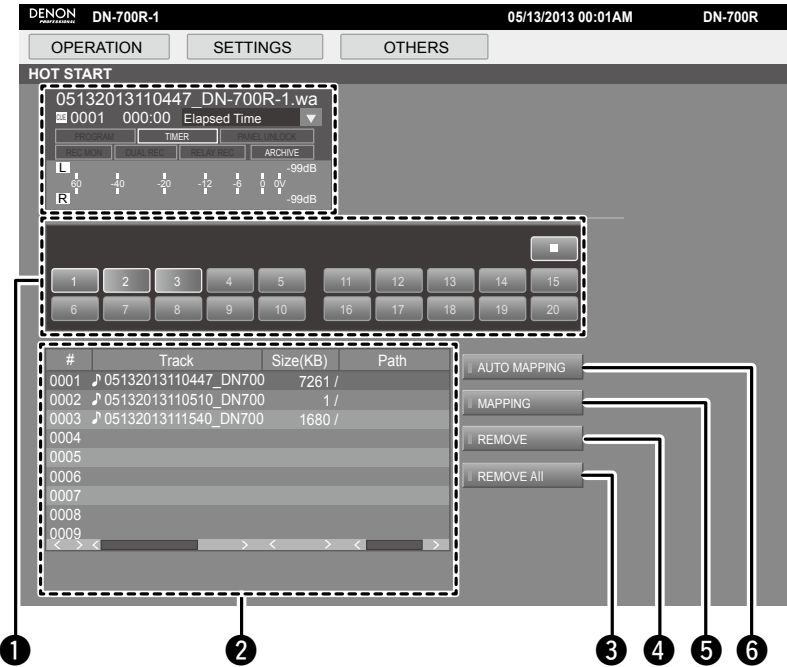

- 1 Hot Start buttons
Playback of the track assigned to the button starts.
- 2 Hot Start track list
- 3 REMOVE All button
Cancels all assigned Hot Start numbers.
- 4 REMOVE button
Cancels assignment of the selected Hot Start number.
- 5 MAPPING button
Individually assigns a file to the number selected in the Hot Start list.
Press this button to display the file list and select a file you want to assign to Hot Start.
- 6 AUTO MAPPING button
Automatically assigns up to 20 files to Hot Start from the top of the current file list.

Playback timer setting screen (PLAY TIMER)

- Can only be operated in the stopped state.
- For details, see “Timer playback start time and playback file settings” (page 45).

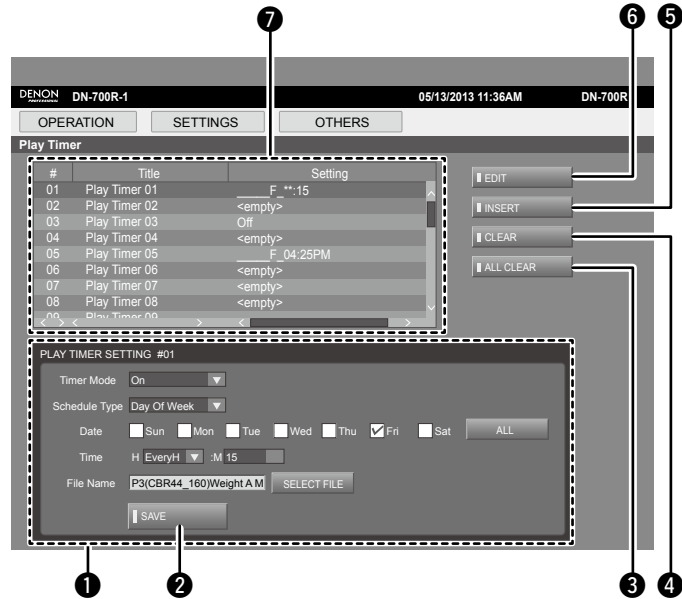

- 1** PLAY TIMER SETTING
Sets the playback timer information (playback start time, playback file).
- 2** SAVE button
Enters the PLAY TIMER SETTING information.
- 3** ALL CLEAR button
Clears all timers.
- 4** CLEAR button
Clears the timer indicated by the cursor.
- 5** INSERT button
Inserts an EMPTY timer to the position above the cursor and shifts all subsequent items down one level.
The last item is deleted.
- 6** EDIT button
Edits the timer settings indicated by the cursor.
- 7** Playback timer list

Recording timer setting screen (REC TIMER)

- Can only be operated in the stopped state.
- For details, see “Timer recording start time and recording time settings” (page 35).

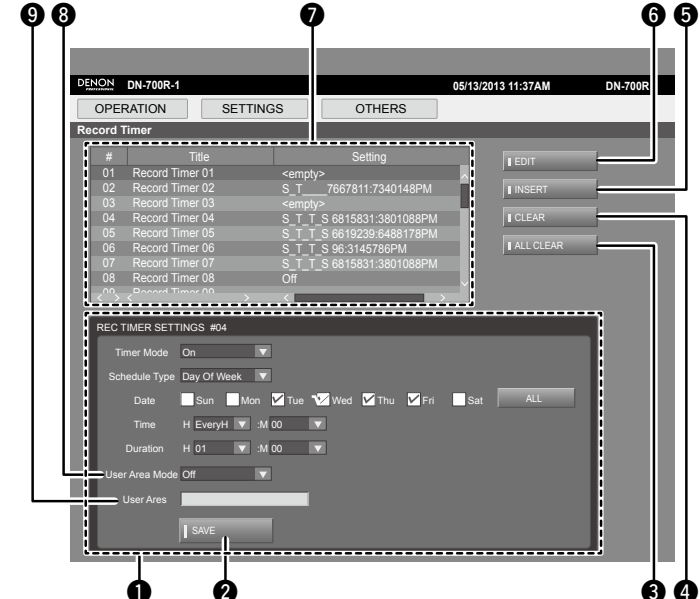

- 1** REC TIMER SETTING
Sets the recording timer information (recording start time, recording time).
- 2** SAVE button
Enters the REC TIMER SETTING information.
- 3** ALL CLEAR button
Clears all timers.
- 4** CLEAR button
Clears the timer indicated by the cursor.
- 5** INSERT button
Inserts an EMPTY timer to the position above the cursor and shifts all subsequent items down one level.
The last item is deleted.
- 6** EDIT button
Edits the timer settings indicated by the cursor.
- 7** Recording timer list
- 8** User Area Mode button
Selects whether or not to use the user area.
- 9** User Area
Enters information to be added to the recorded file name.

Archive setting screen (Archive)

- For details on the setting items, see "Archive Setting" (page 54).

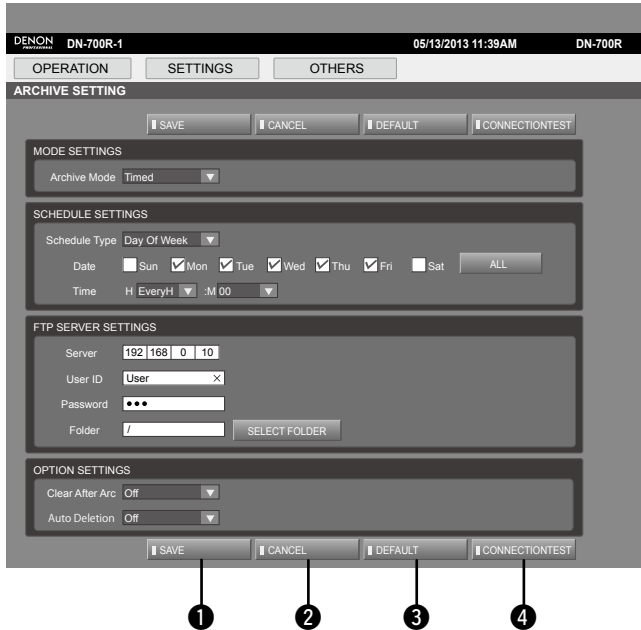

- 1** SAVE button
Saves the changed settings.
- 2** CANCEL button
Returns the settings being edited to the state before editing.
- 3** DEFAULT button
Initializes the setting details for archiving.
- 4** CONNECTION TEST button
Performs a test access to the server based on the server settings.

Preset Setting Screen (PRESET)

- Changes can only be made when in the STOP mode.
- For details on the setting items, see "Preset Setting" (page 18).

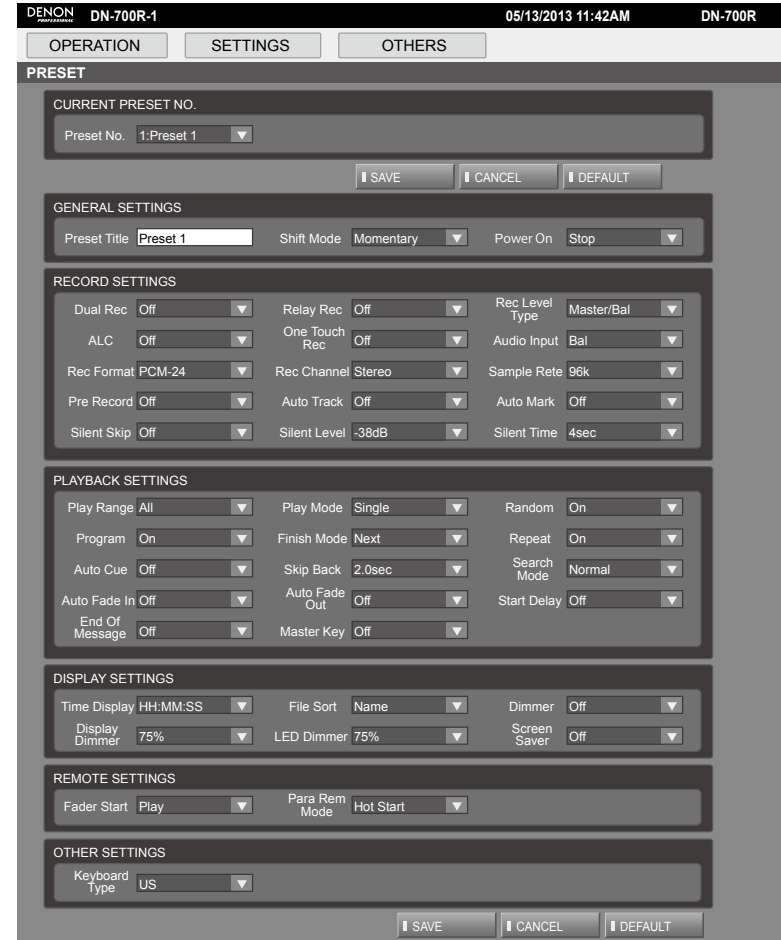

System Setting Screen (SYSTEM)

- Changes can only be made when in the STOP mode.
- For details on the setting items, see “System Setting” (page 21).

Utility Screen (UTILITY)

- Changes can only be made when in the STOP mode.
- For details, see “Menu Operations (Utility)” (page 24).

- 1 Firmware Version Information Display.
- 2 A firmware update file can be uploaded.
Press the [BROWSE] button to navigate and select the update file.
Messages are displayed during the update, and the browser window needs to be closed before reboot.
- 3 Uploads and downloads preset files.
- 4 Sets the DN-700R clock.
Set the time and press the [ADJUST] button.
- 5 Downloads the log file.
- 6 Displays the login user list.
Press the [DISCONNECT] button to disconnect the connection with the current user.
- 7 Press the [STANDBY] button to turn the unit power off.

A confirmation dialog appears when the POWER STANDBY button is pressed.
 OK: The screen switches to the Power Off screen.
 CANCEL: No screen transition.

Various playback functions with RC-F400S

You can perform Hot Start playback by using the hot start remote control RC-F400S (sold separately).

RC-F400S features

- Quick file search with the jog dial.
- Large 3.8" display (320X240 dots).
- Stationary top panel operations.



With RC-F400S, you can only perform playback operations. You cannot set various menu modes (menu list/file list/file menu). When you are making changes in the menu, the RC-F400S will display "wait...".

NOTE

If the firmware version of your RC-F400S is an earlier version than A-5.00 it will not work correctly with the DN-700R. Please visit our website (URL:<http://www.d-mpro.com>) for the latest firmware version. The RC-F400S version information is displayed under the startup screen that appears when it is turned on.

Part names and functions

RC-F400S top panel

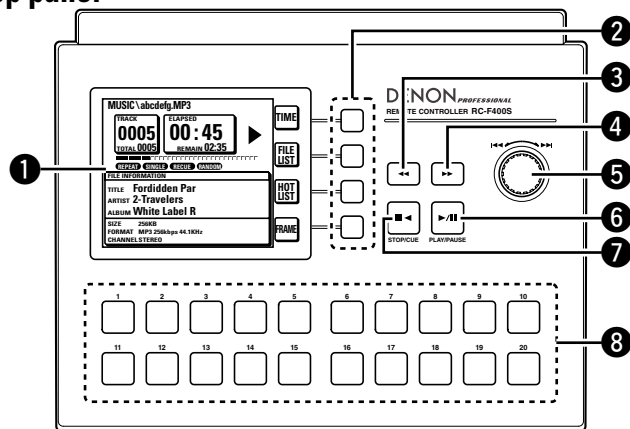

- 1 Display** (66)
- 2 Function buttons** (66)
Correspond to the function display.
- 3 Fast rewind button (◀◀)** (68)
- 4 Fast forward button (▶▶)** (68)
- 5 Jog dial (|◀◀/▶▶|)** (69)
 - Rotate the jog dial to search for folders and files.
 - Press the jog dial to play back the selected file.
- 6 Play/Pause button (PLAY/PAUSE)** (68)
The green light is on during playback and the green light flashes during pause.
- 7 Stop/Cue button (STOP/CUE)** (68)
Lights orange during stop or cuing.
- 8 Hot start buttons (1-20)** (68)
Corresponds to the Hot Start list.

RC-F400S rear panel

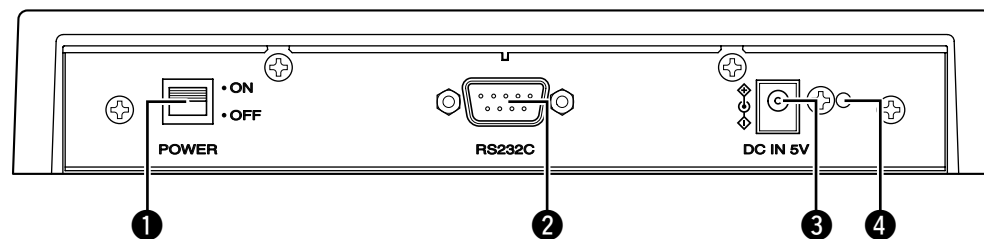

- 1 Power switch** (68)
- 2 RS-232C terminal** (67)
- 3 DC power input terminal** (67)
Connect the supplied power cord.
- 4 DC power cord holder mounting hole**
The supplied power cord holder will prevent the connected power cord from disconnecting from the terminal.

RC-F400S display

Main screen display

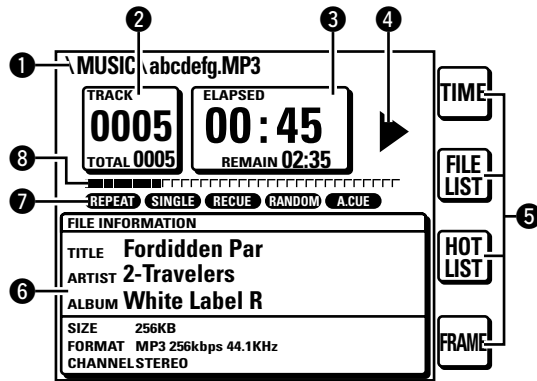

- 1** File name display
- 2** File number/total file count display
- 3** Time display
- 4** Operating Status Display
- 5** Function Display
 - TIME: Press the function button to switch the time display.
 - FILE LIST: Press the function button to play back the file in the file list mode.
 - HOT LIST: Press the function button to check the Hot Start list.
- [Special Feature of DN-700R]**
- FRAME: Press the FRAME button to start Audible pause from that position, and switch to frame search mode.
- 6** File information display
- 7** Current playback mode display
- 8** Playback elapsed position

File list display

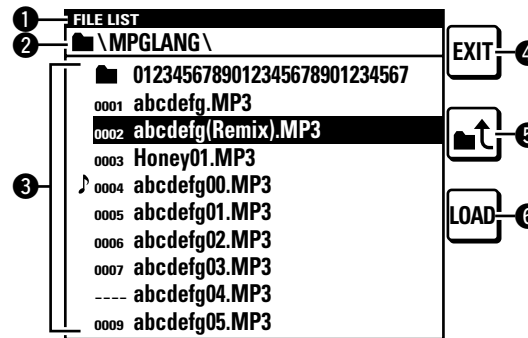

- 1** Title display
Displays "FILE LIST".
- 2** Folder display
Displays the folder name.
"PROGRAM PLAY" is displayed during program playback.
- 3** File list
Displays file names.
The ♪ mark is displayed for the file that is currently being played back or set to be played back.
- 4** EXIT button
Enters the main mode.
- 5** Up arrow button
Displays the list of folders in the selected media.
- 6** LOAD button
Sets the selected file to one of the Hot Start buttons 1-20.

Hot Start list display

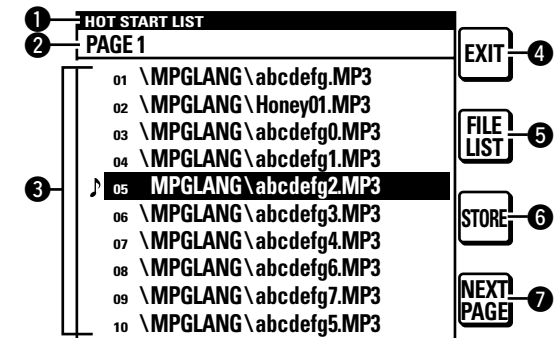

- 1** Title display
Displays "HOT START LIST".
- 2** PAGE display
Displays the page.
- 3** Hot Start list
Displays the set file name.
The ♪ mark is displayed for the file that is being played back.
- 4** EXIT button
Enters the main mode.
- 5** FILE LIST button
Moves to the file list.
- 6** STORE button
When the media is set to USB, the set Hot Start list is saved as a file.
The PPL file is saved in the root directory.
 - A PPL file is the file that saves the content of a Hot Start list.
- 7** NEXT PAGE/PREV PAGE buttons
Display the list in the next/previous page.

Connection

As shown below, connect the RS-232C port on DN-700R to the RS-232C port on RC-F400S using the straight cable that is supplied with RC-F400S.

- Once they are connected, turn the power switch on for the respective devices.
- Configure the following items in the DN-700R "System Setting".
 - Serial bit Rate: 38400
- After connection, fix the cable by turning the cable terminal screws.

Notes on connecting the AC adapter

- Always turn the power switch off before connecting/disconnecting the AC adapter.
- Do not touch the AC adapter with wet hands.
- When disconnecting the AC adapter, make sure that you hold the plug. Pulling or bending the cord may damage the cord or cause electric shock or fire.

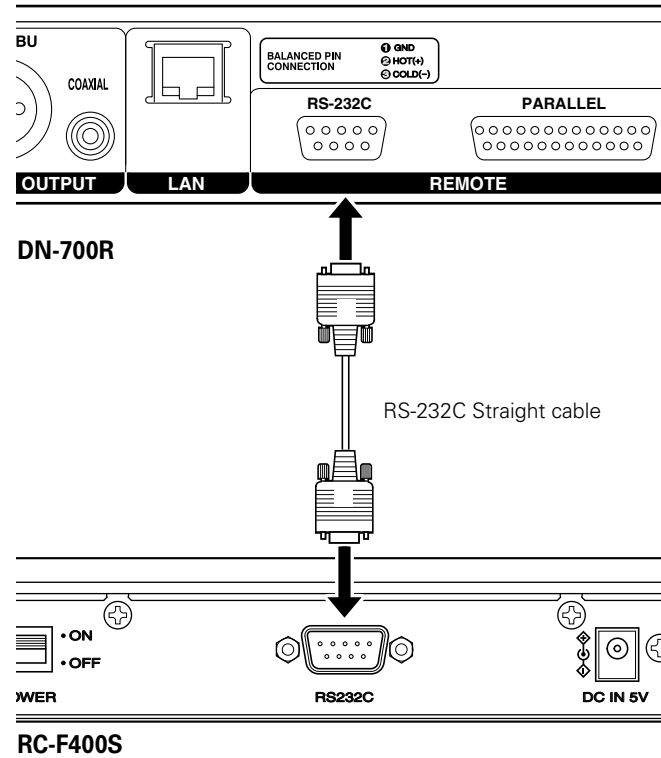

Hot Start playback

You can instantly start playing back a file that is registered with the Hot Start buttons 1-20 on RC-F400S by pressing the corresponding button.

☐ Perform Hot Start playback

1 After connecting DN-700R to RC-F400S, turn the power switch on for the respective devices.

- In the RC-F400S display, the startup screen "DENON PROFESSIONAL" appears.
- When the startup is completed, the file information is shown in the display.

2 Press **HOT LIST** on the main screen.

- The first 10 files in the Hot Start list are displayed.
- To display files 11 through 20 in the Hot Start list, press **NEXT PAGE**.

3 Press the Hot Start button for playback.

- Hot Start playback starts.



Hot Start can also be performed from the main screen and the file list screen.

☐ Pause

During playback, press ►/||.

- During pause, ►/|| flashes.
- To resume playback, press ►/||.

☐ Stop

Press ■◀.

☐ Fast forward and fast rewind (search)

During playback, press ◀◀ or ▶▶.

- Press ◀◀ to perform fast rewind playback.
- Press ▶▶ to perform fast forward playback.
- The fast forward/fast rewind speed changes in the order shown below each time the button is pressed.
 - x2, x10, x50, x100, x200

☐ Audible Pause

Press **FRAME** on the main screen.

- Press **FRAME** on the main screen during playback or pause to switch to the Audible Pause state.

☐ Jumping by frames (Frame Accurate Search)

Press ◀◀ or ▶▶ during Audible pause.

- Pressing ◀◀ moves 1 frame in the reverse direction.
- Pressing ▶▶ moves 1 frame in the forward direction.

❑ Set and allocate the Hot Start folder

The first 20 files in the selected folder are automatically allocated to the Hot Start buttons.

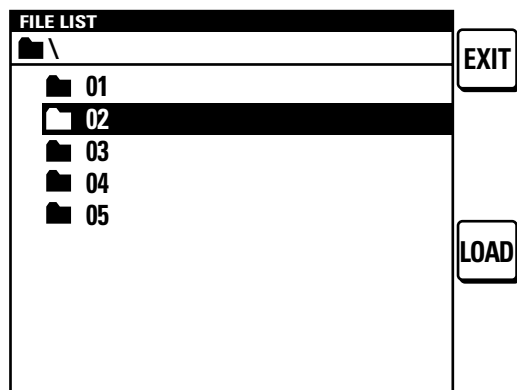

- 1 On the main screen, press FILE LIST.**
The "File List" is displayed.
- 2 Select the folder you would like to set with the jog dial.**
- 3 Press LOAD.**
The first 20 files in the selected folder are automatically assigned to the hot start button.
"Completed" is displayed, and the settings are completed.



These settings can only be configured during stop or pause modes.

❑ Set and allocate Hot Start points

Assign the Hot Start button for the file or point that you would like to play back.

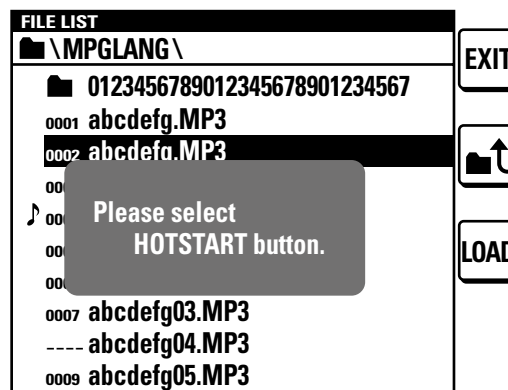

- 1 On the main screen, press FILE LIST.**
The "File List" is displayed.
- 2 Select the file you want to set with the jog dial.**
Or, pause at the point where you want to resume playback in the set file.
Press the jog dial to play back the selected file.
- 3 Press LOAD.**
"Please select HOT START button" is displayed.
To cancel, press .
- 4 Press the Hot Start button you want to allocate the setting to.**
"Completed" is displayed and the setting has changed.
Press the set button to perform Hot Start playback.



Hot Starts can only be set in the stop or cue modes.

❑ Save the Hot Start list

Convert the allocated Hot Start list into a file and save it to a current media connected to the DN-700R. If this file exists in the media, the Hot Start list in this file is automatically used for allocation.

- 1 On the main screen, press HOT LIST.**
The Hot Start list is displayed.
- 2 Press STORE.**
 - The Hot Start list is saved as "DN-700R.ppl" in the root directory of the media connected to the DN-700R.
 - A saved PPL file can be re-read by operating the DN-700R.

NOTE

When the Hot Start list is loaded and any audio file in the list is missing on the media, that file is removed from the Hot Start list.

Playback from the main screen

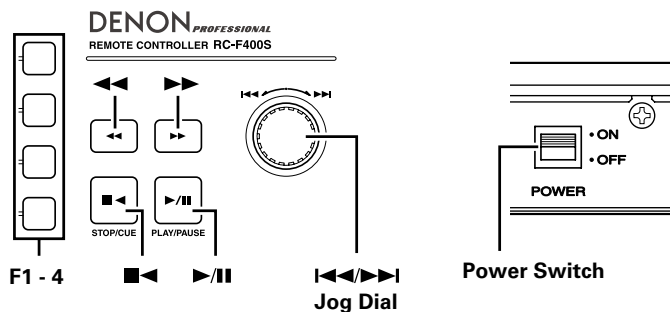

Before playback

After connecting the DN-700R to the RC-F400S, turn the power switch on for the respective devices.

- The RC-F400S display shows the startup screen "DENON PROFESSIONAL".
- When the startup is completed, the file information is shown in the display.

Play back

Press ►/||.

The button lights green and file playback starts.

Pause

Press ►/|| during playback or search modes.

- ►/|| flashes during pause.
- To restart playback, press ►/||.

CUE

Press ■◀.

STOP

Press ■◀ during cue.

Repeat playback (0.5 sec)

Press FRAME.

Switching files (◀◀/▶▶)

During playback, stop or cue, rotate the jog dial.

- Rotate clockwise to switch to the next file.
- Rotate counterclockwise to switch to the beginning of the current file or the previous file.
- To switch to the previous file, rotate the jog dial counterclockwise within one second from the start of file playback.

Fast forward or fast rewind (search)

During playback, press ◀◀ or ▶▶.

- Press ◀◀ to perform fast rewind playback.
- Press ▶▶ to perform fast forward playback.
- The fast forward/fast rewind speed changes in the order shown below each time the button is pressed.
 - x2, x10, x50, x100, x200



- If the "Search Mode" settings in the "Preset Menu" of the DN-700R are set to "Normal", sound is output when the search speed is 2x. Please note that sound is not output at search speeds above 2x.
- After you fast forward to the end of the last file or fast rewind to the beginning of the first file, the unit pauses.
- When you fast rewind to the beginning of the file, the fast rewind operation continues from the end point of the previous file.

NOTE

- When you perform search on a short file, the indicated speed may not be available.
- You cannot perform search on files that are recorded in VBR.
- If searched files contain a VBR file, the search stops at that VBR file.

Jump by frames (Frame Accurate Search)

Press ◀◀ or ▶▶ during Audible Pause.

- Pressing ◀◀ moves 1 frame in the reverse direction.
- Pressing ▶▶ moves 1 frame in the forward direction.

AUTO CUE

AUTO CUE automatically detects the audio level and performs the cue operation.

- When AUTO CUE is enabled, the playback mode display in the RC-F400S display shows **A.CUE**.
- The detected level is the set value for the preset menu "25 Auto Cue" (page 19).
- If the audio level is not detected for 20 seconds or more after the playback for automatic detection of the audio level has started, the cue operation is performed at the beginning of the file.

Serial remote control function

In the serial remote control function, a host such as a computer is connected to the unit. By sending control commands from the host to the unit, the unit can be operated, and the status information of the unit can be checked both on the unit and host. There are 2 methods for connecting the host and unit, RS-232C control and IP Control.

RS-232C control

You will be able to perform the three control functions from the host by connecting an RS-232C straight cable to the RS-232C serial terminal (9-pin D-sub) connector.

[Three control functions]

- ① Controlling the DN-700R externally
- ② Sending the status information to the host when DN-700R receives a status request command from the host
- ③ Automatically sending the status information to the host when there is a change to the DN-700R status

□ About Connections

- Transmission System: Asynchronous full duplex transmission
- Compatible connector: 9-pin D-sub (male)
- Communication speed: 9,600/38,400 bps selectable (System Setting: Serial Bit Rate)
- Data bit: 8 bit
- Parity: None
- Start bit: 1 bit
- Stop bit: 1 bit
- Flow control: None

Pin arrangement

Pin number	Signal name
1	Ground
6	NC
2	TxD
7	RTS*
3	RxD
8	NC
4	NC
9	NC
5	S. Ground

* 4V/500mA power supply can be used for RTS.

□ Connections

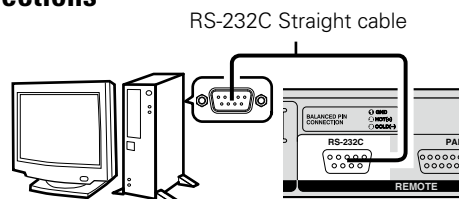

IP control (Ethernet)

You will be able to perform the three control functions from the host by connecting an Ethernet cable to the Ethernet connector. (Connector type:RJ-45 (10BASE-T/100BASE-TX))

□ Communication format

- Communication system: A full duplex
- Communication speed: 10 Mbps/100 Mbps
- Communication port: TCP port 23 (telnet)
- Communication data length: 135 bytes (maximum)

□ Connections

① Connecting the unit and host directly

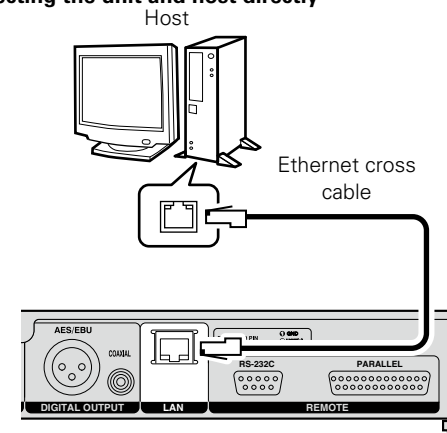

② Connecting the unit and host via a Switch/Router

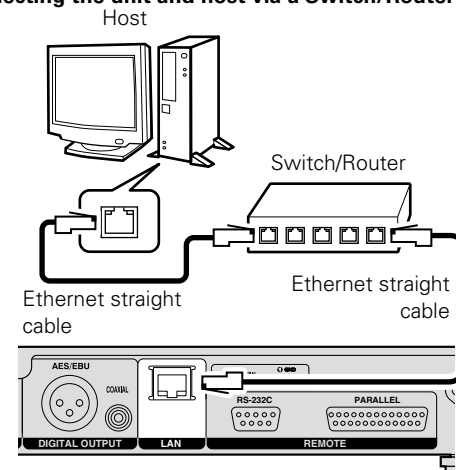

D&M RC communication format

❑ Configuration of control commands

The packets of control commands start with the Start Character “@”, and end with the End Character “0x0D” as shown below.



❑ Configuration of command codes

Item	Value (Hex value within parentheses)
Start Character	'@' (0x40)
ID	'0' (0x30)
Command	Indicates the command details.
End Character	^r' (0x0D)



Response timeout is 100msec.

❑ ACK (received successfully) and NACK (receive failed) command codes

Content	Hex value	Transmission conditions
ACK	0x06	-
NACK	0x15	<ul style="list-style-type: none"> • When an End Character (0x0D) is received with no Start Character “@” • When a command that does not exist is received • When there is a space more than 5msec between command characters



- When a command is received, ACK or NACK is returned within 100 msec.
- If there is no response after 100 msec, the next command is permitted.

① External control and operation of the DN-700R

When the DN-700R receives a control command from the host, the DN-700R sends ACK (received successfully) to the host and executes the command.

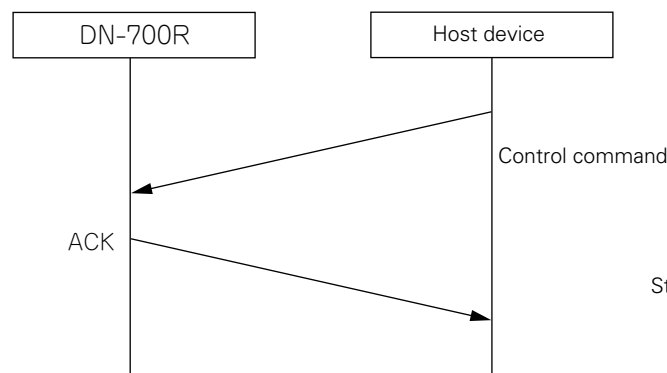

However, if data other than a specified command or an End Character (0x0D) with no Start Character ‘@’ is received, receive fails and NACK is returned.

② Status information output for external status request commands

When a status request is received from the host, the DN-700R returns ACK and a response to the request details.

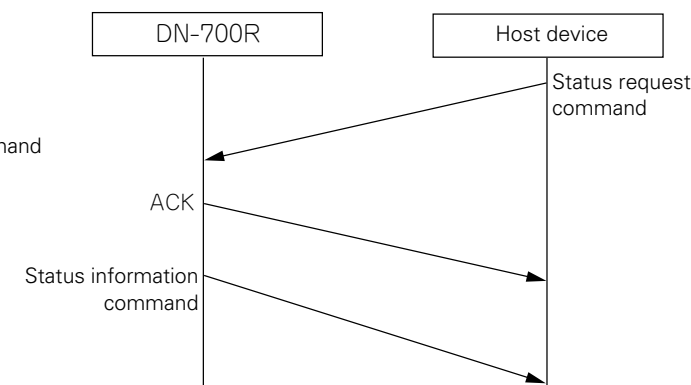

Sequence diagram of status request command

However, if data other than a specified command or an End Character (0x0D) with no Start Character (‘@’) is received, receive fails and NACK is returned.

③ Automatic output of status information when the DN-700R status changes

When the DN-700R status or recording or playback file changes, or when the storage status changes, the details of the change of status are sent to the host.

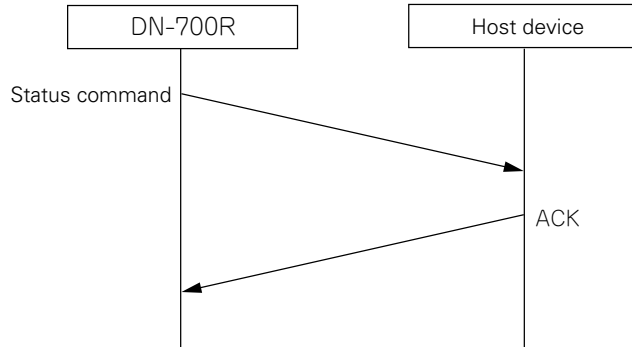

The command sent at this time uses the same status information command as ②.



About the command list see page "Appendix".

Parallel control

Parallel control has two modes, normal mode and hot start mode. The MODE 1,2 pins are used to switch this mode.

Parallel remote mode switching

Parallel remote mode is switched according to the status of parallel remote inputs #5 and #6.

MODE 1	HIGH	LOW	LOW	HIGH
MODE 2	HIGH	HIGH	LOW	LOW
FUNCTION	Normal mode	Hot start		Reserved
		① Mode	② Mode	

- Hot Start ①: Hot list #1 - #10 can be played from the parallel remote.
- Hot Start ②: Hot list #11 - #20 can be played from the parallel remote.



- Hot start is a function that starts playback instantaneously from the preset point. Hot Start mode can be switched to Hot Cue using "40 Para Rem Mode" (page 20) in the "Preset setting". If the mode is set to the Hot Cue mode, when Hot Start input is performed, playback does not start immediately and instead switches to the standby state at the start point.
- Operations for the FADER START terminals can be set in "39 Fader Start" (page 20) in "Preset Setting".

Hot Start Assignment

If one of the HOT START terminals is shorted when the RELOAD terminal is in the shorted state, the current track is assigned to the shorted Hot Start number (reload function). For details on assigning Hot Start, see "Hot Start playback" (page 68).

About Connections

Normal Mode

NO.	DN-700R	
	I/O	NAME
1	-	GND
2		PLAY
3		PAUSE
4		STOP
5		MODE 1
6		MODE 2
7		SEARCH ►►
8		SEARCH ◀◀
9		FADER START
10	-	GND
11		SKIP BACK
12		MARK +
13		MARK -
14	O	PLAY TALLY
15	O	PAUSE TALLY
16	O	CUE TALLY
17		MARK
18		REC PAUSE
19		REC
20	O	STOP TALLY
21	O	REC TALLY
22	-	TALLY POWER SUPPLY
23	-	GND
24		TRACK +
25		TRACK -

Hot Start Mode

Hot Cue Mode

NO.	DN-700R	
	I/O	NAME
1	-	GND
2		PLAY
3		PAUSE
4		STOP
5		MODE 1
6		MODE 2
7		RELOAD
8		HOT START 1(11)
9		HOT START 2(12)
10	-	GND
11		HOT START 3(13)
12		HOT START 4(14)
13		HOT START 5(15)
14	O	PLAY TALLY
15	O	PAUSE TALLY
16	O	CUE TALLY
17		HOT START 6(16)
18		HOT START 7(17)
19		HOT START 8(18)
20	O	STOP TALLY
21	O	REC TALLY
22	-	TALLY POWER SUPPLY
23	-	GND
24		HOT START 9(19)
25		HOT START 10(20)

- In Hot Cue mode, the status switches to standby for hot start input.
- The (|) contents indicate the assignment for Hot Start 2 mode.

Remote Control Connection

Connection Example

Normal Mode

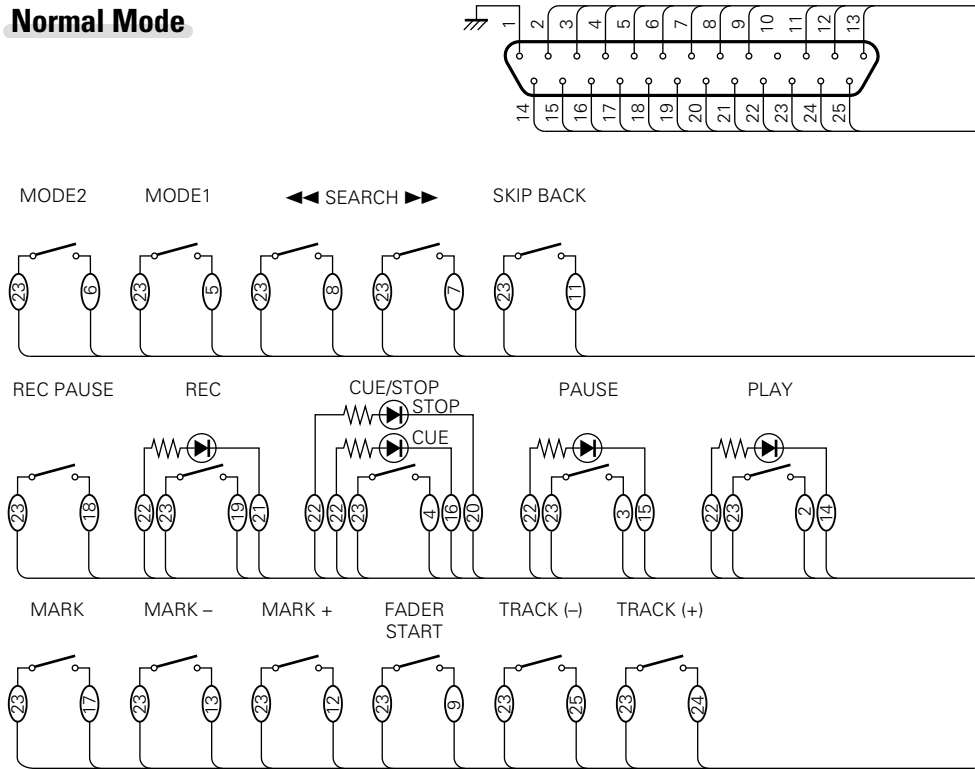

Hot Start Mode

Hot Cue Mode

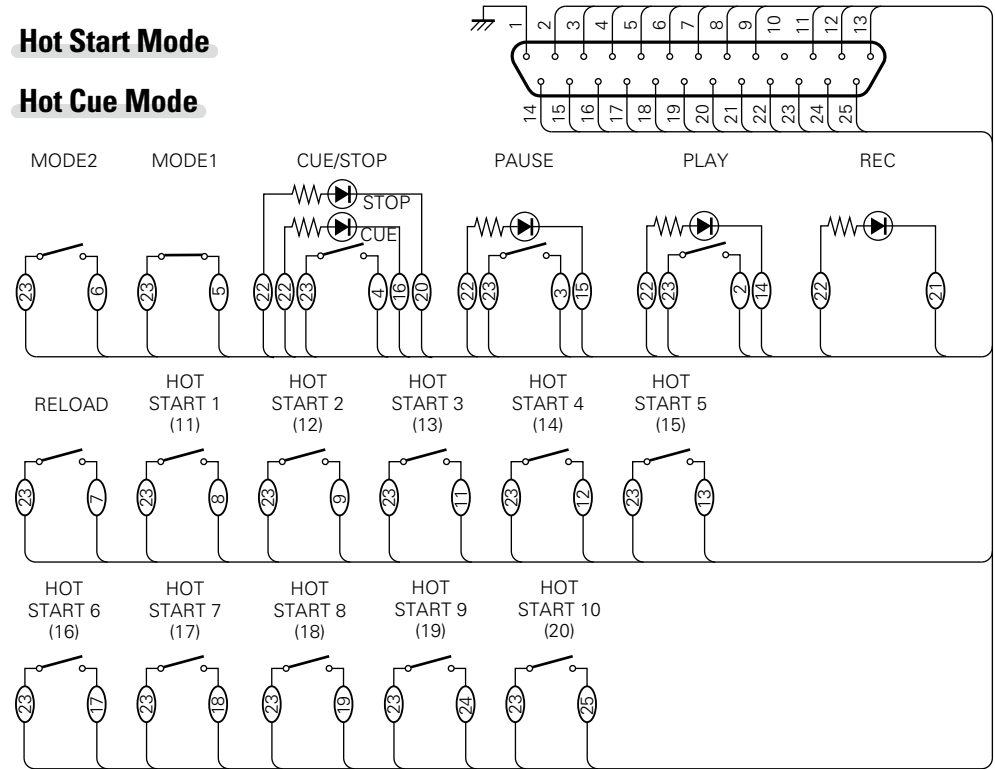

It is assumed that the input pins and Tally output pins are used as follows.

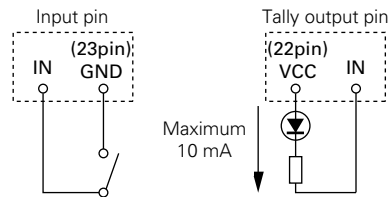

- Tally output pin is an open collector. (Maximum current: 10 mA, maximum voltage; 5.5 V)
- Input pin is 5 V for Vcc TTL specification.
- The maximum current supplied by the Tally Power Supply (22 pin) is 100 mA.
- The input/output logic is active low (negative logic).
- The number indicated in the parentheses () is the number assigned in Hot Start2 mode.

NOTE

Power is supplied to the external remote controller from Pin No.22 (Tally Power Supply) from this terminal. However, as the maximum rating for this pin is +5 VDC 100 mA, select circuit and current controls (resistance values) so as not to exceed the rating. Using this equipment when the rated value is exceeded may cause damage to the equipment, which may also lead to fire or a similar unexpected accident.

Error messages

[Details on procedure for handling error messages]

Error message	Cause/Solution	Page
No Media	<ul style="list-style-type: none"> Cannot detect media. 	70
Unformat	<ul style="list-style-type: none"> The media is formatted in an unsupported format. Format the media on DN-700R or set the format to FAT16 or FAT32. For details, see the operation instructions of the recording media. 	–
Media Full	<ul style="list-style-type: none"> The remaining space on a media is running low. Replace the media with a new one or delete files that are no longer required. 	–
Track Full	<ul style="list-style-type: none"> The number of files on the selected media exceeds 2000. Recording cannot be performed if the number of files exceeds 2000. Replace the media with a new media or delete unneeded files. 	8, 10, 32
Write Inhibited	<ul style="list-style-type: none"> The selected media is write prohibited. Remove the write protection from the media. 	32
File Not Found	<ul style="list-style-type: none"> Target file does not exist. Check the file. 	28
Track Not Found	<ul style="list-style-type: none"> The target track does not exist. Check the media. 	–
Already Exists	<ul style="list-style-type: none"> A file with the same name already exists. <ul style="list-style-type: none"> Copy, Move, Divide : Check the folder. Rename : Change the file name before entering the name. 	28
Err Media XX	<ul style="list-style-type: none"> Not supported on this unit. Replace the media. 	–
VBR	<ul style="list-style-type: none"> This error message appears when a VBR file search is performed. Search cannot be performed on VBR files. When the selected track is VBR format, the estimated remaining time is displayed. 	41, 70
Not Allowed Not Available	<ul style="list-style-type: none"> This appears when an invalid operation is performed. The operation may be disabled due to other setting items such as the preset menu, etc. Check the details of the operation. 	15
No Mark	<ul style="list-style-type: none"> There are no marks for the mark jump. Set marks. 	42
Some files are skipped	<ul style="list-style-type: none"> There is a file with the same name in the copy or move location. Files with the same name cannot be copied or moved. 	30
ALC	<ul style="list-style-type: none"> The Rec Level cannot be changed when the ALC settings are enabled. Turn the ALC settings off to change the Rec Level. 	18, 32
Registered	<ul style="list-style-type: none"> The file that you are to a program, hot start or timer playback list. Files registered to these lists cannot be edited. 	30, 43, 45, 47

[Dual Recording Error Display]

Error message	Cause/Solution	Page
No Back Up Media (XXX)	<ul style="list-style-type: none"> Back up media cannot be detected. 	34
Media Write Inhibited (XXX)	<ul style="list-style-type: none"> The back up media is write prohibited. Remove the write protection from the media. 	34
Back Up Media Full (XXX)	<ul style="list-style-type: none"> There is no free space on the back up media. Replace the media with a new media or delete unneeded files. 	34
Dual Rec Canceled (W01)	<ul style="list-style-type: none"> The selected media is the same as the back up media set in the preset settings. Dual recording is canceled and normal recording is performed. 	34
Dual Rec Canceled (W02)	<ul style="list-style-type: none"> The recording monitor is on. Dual recording is canceled and normal recording is performed. 	34

* XXX: SD1, SD2, USB

[Relay Recording Error Display]

Error message	Cause/Solution	Page
No Secondary Media (XXX)	• The secondary media cannot be detected.	34
Secondary Media Write Inhibited (XXX)	• The secondary media is write prohibited. Remove the write protection from the media.	34
Secondary Media Full (XXX)	• There is no free space on the secondary media. Replace the media with a new media or delete unneeded files.	34

* XXX: SD1, SD2, USB

[Network Error Display]

Error message	Cause/Solution	Page
Server Not Found	• The server is not connected. Or, the server cannot be found.	53
Account Error	• Cannot log in to the server.	53
Folder Not Found	• Cannot find the archive destination folder.	53
Err Media XXX	• Cannot obtain information from the selected media.	53
Server Media Full	• The server capacity is full.	53
Err Network	• An error has occurred while transferring the data.	53

* XXX: SD1, SD2, USB

[RC-F400S error messages]

Error message	Cause/Solution	Page
Not Connected	• Check if it is properly connected to DN-700R. If this message persists, replace the cable.	-
Not Supported	• A device that is not supported by RC-F400S is connected. Check the connected device.	-
No Media	• The media inserted in DN-700R has not been detected. Eject and insert the media again.	70

Troubleshooting

If a problem should arise, first check the following:

1. Are the connections correct?

2. Is the set being operated as described in the owner's manual?

3. Are the external devices (mixer and player) operating properly?

If this unit does not operate properly, check the items listed in the table below.

If the symptom is not covered on the check list, contact your dealer or service centers.

Service centers are listed at <http://www.d-mpro.com>.

[General]

Symptom	Cause/Solution	Page
Does not power on.	• Check whether the power cord is firmly connected to the AC outlet.	13

[Recording]

Symptom	Cause/Solution	Page
Cannot perform recording.	• The recording media could be the cause of this trouble. Replace the recording media with another one and retry.	32
Although the music has been recorded properly, no sound is reproduced when it is played back.	• Make sure that the recording level adjustment switch (REC LEVEL) is not set to Mute. • Make sure that the recording settings (such as input source and selected recording media) and all connections with external devices are correct. (For example, if "UnBal" is set in "09 Audio Input" and an external device is not connected to the analog input RCA terminal, this unit will record in the silent state.)	32 18
There are sound cutoffs between files.	• There may be minor sound cutoffs between files depending on the capacity of a recorded file.	18, 32, 38
There are sound cutoffs during recording to an SD card.	• If an SD card is formatted on a computer, it may cause sound cutoffs during recording. When you use an SD card with this unit, make sure to format the card on this unit.	26, 32
There is a loud noise in the recorded file.	• Check the level meter and Level Over Display (LEVEL) to make sure that the recording level does not exceed 0dB.	10
	• Make sure that the electrical contacts of the cable connections are not poor.	11

[Playback]

Symptom	Cause/Solution	Page
Cannot perform playback or does not recognize a file.	• The recording media could be a cause of this trouble. Copy a file to another recording media and retry playback.	–
	• Check whether this unit supports the format of the playback file.	–
	• Check whether the target folder is within the first 8 levels of the root directory.	28
	• Check whether the number of folders does not exceed 1000. This unit recognizes up to 1000 folders.	28
No sound is produced from the headphones.	• Make sure that the headphone volume level adjustment switch (LEVEL) is not set to MIN.	12
	• Check whether sound is reproduced from the headphones by using another audio file or recording media.	–
Poor sound quality for playback on a computer.	• Check the software of your computer.	–
	• Check the frequency conversion program. • This unit can record audio files using sampling frequencies of 48kHz and 96kHz. Some of the computer programs convert the frequency to 44.1kHz (a sample rate converter is used). Use a higher quality sample rate converter.	–
Cannot read the files on a computer.	• Check the functions of the computer software. Some playback and editing programs may not support the recording format of this unit (PCM 24 bits, 96kHz, etc.).	–

[Recording media]

Symptom	Cause/Solution	Page
The media is not shown in the display even though it is connected.	• Sometimes this unit cannot recognize media because of a defective connection. Check the connection of the media.	70
	• This unit supports USB mass-storage class flash memory and USB external storage. It does not recognize USB drives other than the above.	70
	• You cannot connect USB devices to this unit via a USB hub. • Make sure to supply external power to the type of USB hard disk drives that can connect to the external power source via AC adapter, etc.	70 –
The media icon is displayed, but the unit does not recognize a file.	• Check the display and make sure that the currently selected media and the actual media that you want to use are the same. If they are not the same, display the media list to select the media to be used.	27

[Operation]

Symptom	Cause/Solution	Page
Cannot add a character during renaming.	• If the maximum number of characters has been already entered, you cannot add any more characters. To add a character, delete characters before adding.	79

Main specifications

- **System** Network SD/USB Recorder
- **Compatible media** SD/USB memory/USB HDD
- **Playable formats, file systems** SD, USB: FAT16/FAT32/HFS+
- **Playable WAV Format**
 - **Extension** WAV, AIFF, AIF
 - **Resolution** 16 bit, 24 bit
 - **Sampling frequency** 96, 48, 44.1 kHz
- **Playable MP3 Format**
 - **Extension** MP3
 - **Bit rate** 32 – 320 kbps and VBR
 - **Sampling frequency** 48, 44.1 kHz
- **Playable AAC Format**
 - **Extension** M4A
 - **Compression method** AAC-LC
 - **Bit rate** 64 – 320 kbps and VBR
 - **Sampling frequency** 48, 44.1 kHz
- **Number of channels** 2 (stereo), 1 (mono)
- **Audio frequency characteristics** LINE / MIC(–16 dBu)
20 Hz – 20 kHz
(+0.5 dB / –1 dB)
More than 89 dB
(A-Weighted)
- **S/N ratio** Less than 0.01 %
- **Total harmonic distortion** More than 106 dB
(for 24 bit WAV playback)
- **Dynamic range** Less than –90 dB
–16 % – +16 %
- **Channel separation** ±2.0 dB
- **Variable pitch width**
- **Variable trim adjustment width**

□ Others

- **Maximum storage capacity** Up to 2 TB
- **Maximum file size** 2 GB
- **Maximum number of files** 2000 files
(for 1 folder)
- **Maximum number of folders** 1000 folders
- **Maximum number of folder hierarchies** 8 (under the root directory)

□ Input

- **BALANCED ANALOG IN L/R**
 - **Type** XLR(1:GND, 2:Hot, 3:Cold)
 - **Line setting** +4 dBu
 - **Input level** +24 dBu/+20 dBu/+18 dBu
 - **Maximum input level** 20kΩ/kohms
 - **Input impedance**
 - **MIC setting** –60 – 16dBu
 - **Input level** 5 kΩ/kohms
 - **Input impedance** Less than –127 dBu
(Rs=150 Ω/ohms)
 - **EIN** More than 80dB
- **CMRR**
- **UNBALANCED ANALOG IN L/R**
 - **Type** RCA terminal
 - **Input level** –10 dBV
 - **Maximum input level** +10 dBV/+6 dBV/4 dBV
 - **Input impedance** 10 kΩ/kohms
 - **Format**
- **UNBALANCED DIGITAL IN**
 - **Type** RCA terminal
 - **Input impedance** 75 Ω/ohms
 - **Standard input level** 0.5 Vp-p
 - **Format** IEC-60958(COAXIAL)
- **BALANCED DIGITAL IN**
 - **Type** XLR(1:GND, 2:Hot, 3:Cold)
 - **Input impedance** 110 Ω/ohms
 - **Standard input level** 3.5 Vp-p
 - **Format** IEC-60958(AES/EBU)

□ General

- **Power supply** AC 120 V, 60 Hz
(U.S.A and Canada models)
AC 230 V, 50/60 Hz
(European, U.K and Asia/
Pacific models)
- **Power consumption** 30 W
0.4 W (standby)
3.4 W (Network standby)
- **Environmental conditions**
 - **Operating temperature** 5 – 35 °C
 - **Operating humidity** 25 – 85 %, no condensation
 - **Storage temperature** –20 – 60 °C

□ Output

- **BALANCED ANALOG OUT L/R**
 - **Type** XLR(1:GND, 2:Hot, 3:Cold)
 - **Load impedance** Over 600 Ω/ohms
 - **Output level** +4 dBu at 600 Ω/ohms load
 - **Maximum Output level** +24 dBu/+20 dBu/+18 dBu
- **UNBALANCED ANALOG OUT L/R**
 - **Type** RCA terminal
 - **Load impedance** Over 10 kΩ/kohms
 - **Output level** –10 dBV
 - **Maximum Output level** +10 dBV/+6 dBV/+4 dBV
- **BALANCED DIGITAL OUT**
 - **Type** XLR(1:GND, 2:Hot, 3:Cold)
 - **Output impedance** 110 Ω/ohms
 - **Standard output level** 3.0 Vp-p
 - **Format** IEC-60958(AES/EBU)
- **UNBALANCED DIGITAL OUT**
 - **Type** RCA terminal
 - **Output impedance** 75 Ω/ohms
 - **Standard output level** 0.5 Vp-p
 - **Format** IEC-60958(COAXIAL)
- **HEADPHONE OUT** 20 mW/32 Ω/ohms

Index

A		D		M		S	
Accessories	4	Delete folder	29	Manual track	38	Save Setting	25
Add file	38	Delete mark	31	Marking	38	SD card	13
Add mark	42	Display	8	Media List	27	Search	41
Archive	53	DIVIDE	48	Media Server List	27	Search the marks	42
Auto cue	70	Dual recording	34	Menu List	15	Select all	29
B		E		Menu Operations	17	Serial remote control function	71
Bitrate	39	EDIT	48	Microphone	12	Signal path through monitor	34
C		Error message	76	MOVE	49	Silent skip recording	38
Cable		F		N		Skip back	41
Balanced cable	11	File List menu	28	Network Status	26	Speed Check	26
Coaxial digital cable	11	File move	30	P		System Setting	21
Stereo audio cable	11	File playback	29	Parallel control	74	T	
Change folder name	29	Firmware Version	26	Password	57, 58	Time/Date	25
Changing files	41	Format Media	26	Pitch control	42	Timer playback	45
Character input	21	Frame jump	41, 70	Playback	40	Timer recording	35, 36
COMBINE	48	Front panel	5	Preset name	21	U	
Connections		H		Preset selection	18	UNDO	49
Analog balanced	11	Headphones	12	Preset setting	18	USB Keyboard	50
Analog unbalanced	11	Hot list	47	Product Manager	55	User name	58
Digital	11	Hot Start playback	47	Program playback	43	Utility	24
Digital (AES/EBU)	11	I		Properties display	9	W	
Network (LAN)	51	Initial settings	17	Property	31	Web Remote	58
Parallel	12	IP Control (Ethernet)	71	R			
Power cord	13	K		Random playback	42		
RC-F400S	67	Key lock	31	RC Communication format	72		
RS-232C	12	L		RC-F400S	65		
USB device	14	Language type	20	Rear panel	7		
Control command	72	Load Setting	25	Record	32		
Control function	50			Recording media	13		
COPY	49			Recording monitor	34		
Copy folder	30			Recording time chart	39		
Create folder	30			Relay recording	34		
				Retainer	14		
				RS-232C control	71		

Appendix

Appendix shows the list of commands that control this unit externally through a host device. Normally, it is dealers such as installers that use the list of commands to make settings, so this section is only in English.

□ D&M RC Communication format

Control Command List

Description		Command	Remarks	
KEY	Standby	@02312\r'		
Control	PowerON	@023PW\r'		
	STOP	@02354\r'		
	PLAY	@02353\r'		
	PLAY PAUSE	@02348\r'		
	SKIP BACK	@023SB\r'		
	CUE	@023CU\r'		
	Frame	ON	@0frON\r'	
		FWD	@0fr00\r'	
		RWD	@0fr01\r'	
	FF	ON	@02352\r'	FRAME FWD while the FRAME ON. FWD while STOP, PLAY and PLAY PAUSE When this command is received in FWD, Speed gose up by one step.
		Speed X	@02352X \r'	FWD Speed X X=1:x2, X=2:10, X=3:50, X=4:x100, X=5:x200
	RWD	ON	@02350\r'	FRAME RWD while the FRAME ON. RWD while STOP,PLAY and PLAY PAUSE When this command is received in RWD, Speed gose up by one step.
		Speed X	@02350X \r'	RWD Spead X X=1:x2, X=2:10, X=3:50, X=4:x100, X=5:x200
	Track Jump	nnnn	@0Trnnnn\r'	nnnn:Track No (4 digits)
		nnn	@0TRnnn\r'	nnn:Track No (3 digits)
	Track Jump >>		@02332\r'	
	Track Jump <<		@02333\r'	
	REC		@02355\r'	
	REC PAUSE		@023Rp\r'	
	Rec Monitor	ON	@023RM00\r'	
OFF		@023RM01\r'		
Timer Record Off		@023TO\r'		
M.Track		@023MT\r'	When recording, the file is divided at the position in which the button was pushed. One addition to Track No.	
Mark		@023121 \r'		
Mark FWD		@023M+ \r'	It jumps to the mark of forward.	
Mark RWD		@023M- \r'	It jumps to the mark of reverse.	

Description		Command	Remarks		
Control	PITCH	ON	@02337ON\r'		
		OFF	@02337OF\r'		
		+	@02338\r'		
		-	@02339\r'		
		Value	@0PTSSXXXX\r'	SS:ON/OFF, ON:SS=ON, OFF:SS=OF XXXX:Pitch Value First Sign=0:Plus/1:Minus Second Pitch 10(0~9) Third Pitch 1(0~9) Fourth Pitch 0.1(0~9) Example)ON, :+16.0%:SSXXXX=ON0160 +16.0~-16.0% Range:0.1%	
	A-B	@02359\r'			
	Divide	@023Dd\r'			
	Rec Volume +	@023V+\r'			
	Rec Volume -	@023V-\r'			
	Rec Vol Balanse Right	@023BR\r'			
	Rec Vol Balanse Left	@023BL\r'			
	Rec Vol Right +	@023R+\r'			
	Rec Vol Right -	@023R-\r'			
	Rec Vol Left +	@023L+\r'			
	Rec Vol Left -	@023L-\r'			
	Volume Up	@02016\r'			
	Volume Down	@02017\r'			
	EJECT	@02345\r'			
	HOT START PLAY	Hot Start No nn	@0HPnn\r'	nn:Hot Start No(nn=01~20)	
	HOT START CUE UP	Hot Start No nn	@0HCnn\r'	nn:Hot Start No(nn=01~20)	
	Lock Panel's Key		@023KL\r'		
	Unlock Panel's Key		@023KU\r'		
	SemiLock Panel's Key		@023KS\r'		
	Hot Start List Save		@0HSSR\r'		
	Combine	Track No nnnn	@023CBnnnn\r'		
	UNDO		@023UD\r'		
	File List	Storage	SD1	@0MMS1\r'	
SD2			@0MMS2\r'		
USB			@0MMUS\r'		
NET			@0MMNE\r'		
Select Folder		xxxxxxxx	@0SfXXXX\r'	xxx... Select Folder No	
Make Folder		xxxxxxxx	@0MFxxxxxxxxxxx\r'	xxx... New Folder name (Max 255 words)	
Rename Folder		xxxxxxxx	XXXXXXXXXXXX	@0RFxxxxxxxxxxx:XXXXXXXXXXXX\r'	xxx... changing Folder name(Max 255 words) ※4 '.' Separator XXXX... New Folder name(Max 255 word) ※4
Delete Folder		xxxxxxxx		@0DRxxxxxxxxxxx\r'	Invalid, when the folder name to change does not exist xxx... The folder name to delete (Max 255 words) ※4
				Invalid, when the folder name to delete does not exist	

Description		Command		Remarks
File List	Move File	nnnn	XXXXXXXXXX	@0MvnnnnXXXXXXXXXX\r'
		nnn	XXXXXXXXXX	@0MvnnnXXXXXXXXXX\r'
Copy File		nnnn	XXXXXXXXXX	@0CynnnnXXXXXXXXXX\r'
		nnn	XXXXXXXXXX	@0CYnnnXXXXXXXXXX\r'
Cancel Move File/Copy File				@0CNAL\r'
File Delete(Track Erase)		xxxx		@023Texxxx\r'
		xxxx		@023TExxx\r'
Rename File		nnnn	XXXXXXXXXX	@0RnnnnnXXXXXXXXXX\r'
		nnn	XXXXXXXXXX	@0RNnnnXXXXXXXXXX\r'

Description			Command	Remarks	
File List	HotStart Set	nn	xxxx	@0hsnnxxxx\r'	nn:Hot Start No., xxxx:Track No. (4 digits)(The setting is cancelled in case of 0000.) Usually, the head of a file is saved as a Hot Start starting position at the time. In PLAY PAUSE, when nnn is the same as current Track, a current position is saved as a Hot Start starting position. (Only the file in a current folder can be set up.)
		nn	xxx	@0HSnnxxx\r'	nn:Hot Start No., xxxx:Track No. (3 digits)(The setting is cancelled in case of 000.) Usually, the head of a file is saved as a Hot Start starting position at the time. In PLAY PAUSE, when nnn is the same as current Track, a current position is saved as a Hot Start starting position. (Only the file in a current folder can be set up.)
		nn	NNNNNNNN	@0HsnnNNNNNNNN\r'	nn:Hot Start No., NNNNNNNN:Full Path(The setting is cancelled in case of none.)
	Track Mark Erase			@023Me\r'	All mark of a current track is deleted.
Preset General	Preset Set	XX		@0PSXX\r'	XX=01:Preset1; 02:Preset2 03:Preset3
	Preset Title	n	xxxxxxx	@0PNn:xxxxxxx\r'	n :Preset No. ※3 xxxx... :Set Preset name ※4
	Shift Mode	Momentary		@0SmMO\r'	
		Lock		@0SmLK\r'	
	PowerON	Resume Play		@0PORM\r'	
		Play First		@0POPF\r'	
STOP			@0POST\r'		
REC			@0PORE\r'		
Preset Rec	Dual Rec	Off		@0dROF\r'	
		SD1		@0dRS1\r'	
		SD2		@0dRS2\r'	
		USB		@0dRUS\r'	
	Relay Rec	Off		@0rROF\r'	
		SD1		@0rRS1\r'	
		SD2		@0rRS2\r'	
		USB		@0rRUS\r'	
	Rec level Type	Master/bal		@0RIMA\r'	
		Separate L/R		@0RILR\r'	
	Rec Level	Manual		@0RLMA\r'	
		ALC(Separate)		@0RLSE\r'	
		ALC(Mix)		@0RLMI\r'	
	One Touch Rec	On		@0OR00\r'	
		Off		@0OR01\r'	
	Audio Input	UNBALANSE		@0INUB\r'	
		BALANCE		@0INBA\r'	
		Coaxial(Digi-Unbal)		@0INDI\r'	
AES/EBU(Digi-Bal)			@0INDB\r'		

Description		Command		Remarks	
Preset Rec	RecFormat	WAV(PCM)	XX	@0AFPMXX\r'	XX:Bit length 24bit XX=24 16bit=16
		MP3	XXX	@0AFM3XXX\r'	XXX:Bit rate 320Kbps:XXX=320 256Kbps:XXX=256 192Kbps XXX=192 128Kbps XXX=128 64Kbps XXX=064
	Rec Cannel	STEREO		@0CHST\r'	
		L-Mono		@0CHML\r'	
		LR-MONO		@0CHMX\r'	
	Sample Rate	FS	XX	@0FSXX\r'	XX:Sampling rate 96KHz:XX=96 48KHz:XX=48 44.1KHz:XX=44 Ext(AES):XX=EX
	PreRec	x (sec)		@0PRxS\r'	x sec:x=1 ~ 5 (Sec)
		OFF		@0PR\r'	
	AutoTrack	Time	XXXX	@0ATXXXX\r'	XXXX: 1min=0001,5min=0002, 10min=0010,15min=0015 30min=0030, 1hour=0100, 2hour=0200, 6hour=0600 8hour=0800, 12hour=1200, 24hour=2400 Off=0000
	AutoMark	ON		@0AM00\r'	
		OFF		@0AM01\r'	
	Silent Skip	ON		@0SS00\r'	
		OFF		@0SS01\r'	
	Silent Level	XX		@0SLXX\r'	XX: -20dB=20, -25dB=25 etc A setting kind is the same as the content of the selection of Menu.
Silent Time	XX		@0SCXX\r'	XX: 1sec=01, 5sec=05 etc A setting kind is the same as the content of the selection of Menu.	
Preset Play	Play Range	All		@0pRAL\r'	
		Folder		@0pRFD\r'	
	Play Mode	Single.PLAY		@0PMSP\r'	
		Continuous		@0PMCN\r'	
	Random	ON		@0RN00\r'	
		OFF		@0RN01\r'	
	Program Playback	ON		@0PG00\r'	
		OFF		@0PG01\r'	
	Finush Mode (Shingle Mode)	STOP		@0FMST\r'	
		Next		@0FMNT\r'	
		Recue		@0FMRC\r'	
	REPEAT	ON		@0RE00\r'	
		OFF		@0RE01\r'	
	Auto Cue	OFF		@0AC00\r'	
Level		XX	@0ACXX\r'	XX:-20dB=20, -25dB=25 etc A set kind is the same as the content of the selection of Menu	
SKIP BACK (Time)	xxx		@0SBxxx\r'	xxx=005:0.5sec...	

Description		Command	Remarks	
Preset Play	Search Mode	Normal @0sMNO\r'		
		Silent @0sMSL\r'		
	Auto Fade In	xxx @0FIxxx\r'	xx:set Time Off:xx=00 0.5sec:xx=05, 1.0sec:xx=10, 1.5sec:xx=15	
	Auto Fade Out	xxx @0FOxxx\r'	xx:set Time Off:xx=00 0.5sec:xx=05, 1.0sec:xx=10, 1.5sec:xx=15	
	Start Delay	xxx @0sDxxx\r'	xxx:set Time(10msec) Off:xxx=000 100msec:xxx=010 200msec:xxx=020 300msec:xxx=030	
	EOM(End Of Message)	xx @0EDxx\r'	xx:set Time Off:xx=OF 0.5sec:xx=01 5sec:xx=05, 10sec:xx=10, 15sec:xx=15, 20sec:xx=20, 30sec:xx=30, 60sec:xx=60	
Master Key (Pitch Control)	ON OFF @0KY00\r' @0KY01\r'			
Preset Disp	Time Display	HH:MM:SS MMM:SS:FF @0TDHMS\r' @0TDMSF\r'		
	File Sort	Alphabetical Date/Time @0FRAL\r' @0FRDA\r'		
	Dimmer	ON OFF @0DM00\r' @0DM01\r'		
	Display Dimmer	100%	@0DD00\r'	
		75%	@0DD01\r'	
		50%	@0DD02\r'	
		25%	@0DD03\r'	
	LED Dimmer	100%	@0LD00\r'	
		75%	@0LD01\r'	
		50%	@0LD02\r'	
		25%	@0LD03\r'	
	Screen Saver	ON OFF @0Ss00\r' @0Ss01\r'		
Preset Remote	Fedar Start	Play @0FDPL\r'		
		PlayPause @0FDPU\r'		
		PlayNext @0FDNE\r'		
		Play&Lock @0FDLO\r'		
		Play&LockPause @0FDLP\r'		
		Play&LockNext @0FDLN\r'		
		StartPause @0FDSP\r'		
		StartPauseTrack @0FDST\r'		
		Manual Track @0FDMT\r'		
	Para Rem Mode	Hot Start Hot Start Cue Up @0PAHT\r' @0PAHC\r'		

Description		Command	Remarks	
Preset Other	KeyBoard	English(US)	@0KBUS\r'	
		English(UK)	@0KBUK\r'	
		France	@0KBFR\r'	
		German	@0KBGE\r'	
		Italia	@0KBIT\r'	
		Spanish	@0KBSP\r'	
		Nederland	@0KBNE\r'	
		Swedish	@0KBSW\r'	
	Japanese	@0KBJP\r'		
Preset Default	PresetDefault	Preset(all)	@0DEFL\r'	Default processing to current Preset
Archive Setting	Archive Mode	AUTO	@0ARAT\r'	
		Schedule	@0ARSC\r'	
		OFF	@0AR01\r'	
	Schedule	DayOfWeek	@0asDWxxxxxxxxhhmm\r'	<p>xxxxxx:Day-of-the-week setup The initial ("S", "M", "T", "W", "T", "F", "S") of the day of the week to reserve is connected, and the day of the week which is not reserved is connected by "_". hhmm:Time set If it is "Every time", it is displayed by "***".</p> <p>Example) Every day 12:15 SMTWTFS1215 Example) It starts in 15 minutes every hour except Wednesday and Friday. SMT_T_S**15</p>
		DateTime	@0asDTYYMMDDhhmm\r'	<p>YYMMDDhhmm:Set Time(Year,Month,Day,Hour,Minute) If it is "Every month" or "Every year", it is displayed by "***".</p> <p>Example) 2012Y6M3D12:15 1206031215 Example) 2012Y Every month3D12:15 12**031215</p>
	Server	Archive Server IP	xxx.xxx.xxx.xxx	@0A xxxxxxxxxxxx\r'
Server Account	Archive User Name	xxxxxxxxxxxx	@0AUxxxxxxxxxxxx\r'	A to Z, a to z, 0 to 9 Max 12 words
	Archive Password	xxxxxxxxxxxx	@0APxxxxxxxxxxxx\r'	A to Z, a to z, 0 to 9 Max 12 words
Archive Folder	xxxxxxxxxxxx		@0AOxxxxxxxxxxxx\r'	Input the Path of Folder 12 words • Unit can use 255 words
Auto Deletion	Off		@0ADOF\r'	
	XXh		@0ADXX\r'	XX h(set Time 1h=01)
Clear After Archive	ON		@0CA00\r'	
	OFF		@0CA01\r'	
Archive Default			@0DEAC\r'	

Description		Command	Remarks
Rec Timer	Timer Recording	DayOfWeek	<p>@0ShDWXXxxxxxxxHHMMhhmmXXX\r'</p> <p>XX:Reserve No→ 01-30 xxxxxx:Setting on a day of the week The initial ("S", "M", "T", "W", "T", "F", "S") of the day of the week to reserve is connected, and the day of the week which is not reserved is connected by "_." hhmm:Time set If it is "Every time", it is displayed by "***".</p> <p>Example) Every day 12:15 SMTWTFS1215 Example) It starts in 15 minutes every hour except Wednesday and Friday. SMT_T_S**15</p> <p>hhmm:Recording Time=houre, minute XXXX:UserArea(Min words=0, Max Words=32Words)</p>
		DateTime	<p>@0ShDTXXYYMMDDHHMMhhmmXXX\r'</p> <p>XX:Reserve No→ 01-30 YYMMDDhhmm:Set Time(Year,Month,Day,Hour,Minute) If it is "Every month" or "Every year", it is displayed by "***".</p> <p>Example) 2012Y6M3D12:15 1206031215 Example) 2012Y Every month3D12:15</p> <p>hhmm:Recording Time=houre, minute XXXX:UserArea(Min words=0, Max Words=32Words)</p>
	Delete	@0ShDLXX\r'	XX:ReserveNo 01-30
	All Rec Timer Delete	@0ShAD\r'	

Description			Command	Remarks		
Play Timer	Timer Playback	SET	DayOfWeek	@0TPDWXXxxxxxxxxhmmFFFFF\r'	XX:Reserve No→ 01-30 xxxxxx:Setting on a day of the week The initial ("S", "M", "T", "W", "T", "F", "S") of the day of the week to reserve is connected, and the day of the week which is not reserved is connected by "_." hhmm:Time set If it is "Every time", it is displayed by "***". Example) Every day 12:15 SMTWTFS1215 Example) It starts in 15 minutes every hour except Wednesday and Friday. SMT_T_S**15 FFFFFFFF:File neme(Full Path)	
			DateTime	@0TPDTXXYYMMDDhhmmFFFFF\r'	XX:Reserve No→ 01-30 YYMMDDhhmm:Set Time(Year,Month,Day,Hour,Minute) If it is "Every month" or "Every year", it is displayed by "***". Example) 2012Y6M3D12:15 1206031215 Example) 2012Y Every month3D12:15 FFFFFFFF:File neme(Full Path)	
	Delete		@0TPDLXX\r'	XX:Reserve No 01-30		
	All Play Timer Delete		@0TPAD\r'			
Program List	Program List Insert	nn	NNNNNNNN	@0PInnnNNNNNNNN\r'	nn:Insert Position No. NNNNNNNN:Full Pat	
	Program List Remove	nn		@0Pmnn\r'	nn:Remove Position No.	
	Program List Load	NNNNNNNN		@0PINNNNNNNNN\r'	NNNNNNNN:Full Pat(m3u File)	
	Program List Save	NNNNNNNN		@0PsNNNNNNNN\r'	NNNNNNNN:Full Pat(m3u File)	
Hot List	HotStart Load	NNNNNNNN		@0HLNNNNNNNN\r'	NNNNNNNN:Full Pat	
System Setting	Play Timer Priority	ON		@0tp00\r'		
		OFF		@0tp01\r'		
	Rec Folder	Current			@0RfCU\r'	
		Fixed	NNNNNNNN		@0RfFXNNNNNNNN\r'	NNNNNNNN:Full Pat
	Signal Pass Thru	ON			@0Sp00\r'	
		OFF			@0Sp01\r'	
	User area	ON			@0US00\r'	
		OFF			@0US01\r'	
		xxxxxxxxxxxxxxxxxxxx			@0UAxxxxxxxxxxxxxxxx\r'	xxxxxxxxxxxxxxxx:User Area name(0-32 words) When 0 is set, it is deleted.
	File name form	MN_DT_UA			@0FfMDU\r'	
		MN_UA_DT			@0FfMUD\r'	
		DT_MN_UA			@0FfDMU\r'	
		DT_UA_MN			@0FfDUM\r'	
UA_MN_DT				@0FfUMD\r'		
UA_DT_MN				@0FfUDM\r'		
Mono	ON			@0MO00\r'		
	OFF			@0MO01\r'		

Description		Command	Remarks	
System Setting	Digital Out Fs	AUTO	@0dFAT\r'	
		44.1KHz	@0dF44\r'	
		48KHz	@0dF48\r'	
		Ext(AES)	@0dFEX\r'	
	Line/Mic LCh	Line	@0LMLLN\r'	
		Mic	@0LMLMC\r'	
	Line/Mic RCh	Line	@0LMRLN\r'	
		Mic	@0LMRMC\r'	
	Phantom LCh	ON	@0PhL00\r'	
		OFF	@0PhL01\r'	
	Phantom RCh	ON	@0PhR00\r'	
		OFF	@0PhR01\r'	
	Mic In Sens L-Ch	XX	@0MsLXX\r'	XX:16~60 (dBu)
	Mic In Sens R-Ch	XX	@0MsRXX\r'	XX:16~60 (dBu)
	Volume Input	Fixed	@0VIFX\r'	
		Variable	@0VIVA\r'	
	Ref (XLR/RCA) (FS Reference)	XX	@0FrXX\r'	XX:Set value(dBu) XX=24:XLR=+24dBu / RCA=+10dBV XX=20:XLR=+20dBu / RCA=+6dBV XX=18:XLR=+18dBu / RCA=+4dBV
	Input Trim L	XXX	@0ItLXXX\r'	XXX:Trim set value(+2.0dB~ -2.0dB) XXX=+20:+2.0
	Input Trim R	XXX	@0ItRXXX\r'	XXX:Trim set value(+2.0dB~ -2.0dB) XXX=+20:+2.0
	Output Trim L	XXX	@0OtLXXX\r'	XXX:Trim set value(+2.0dB~ -2.0dB) XXX=+20:+2.0
	Output Trim R	XXX	@0OtRXXX\r'	XXX:Trim set value(+2.0dB~ -2.0dB) XXX=+20:+2.0
	Time Form	12h	@0TF12\r'	
		24h	@0TF24\r'	
	DateForm	MDY	@0DFMD\r'	
		DMY	@0DFDM\r'	
		YMD	@0DFYM\r'	
	Display Contrast (Brightness)	XX	@0BNXX\r'	XX:01-10
Language	English	@0LNUS\r'		
	Japan	@0LNJP\r'		
Machine Name	xxxxxxxxxxxx	@0MNxxxxxxxxxxxx\r'	xxxxxxxxxxxx:Machine Name A to Z, a to z, 0 to 9 Max12 words	
IP Address	xxx.xxx.xxx.xxx	@0IPxxxxxxxxxxxx\r'	xxxxxxxxxxxx:IP Adress Example)IP=192.168.000.002.:xxxxxxxxxxxx=192168000002 Case of AUTO:AUTO00000000	
Sub net mask	xxxxxxxxxxxx	@0SMxxxxxxxxxxxx\r'	xxxxxxxxxxxx:Sub net mask Example)Sub net mask=255.255.255.000.:xxxxxxxxxxxx=255255255000	
Gateway	xxxxxxxxxxxx	@0GWxxxxxxxxxxxx\r'	xxxxxxxxxxxx:Gateway IP Example)IP=192.168.000.005.:xxxxxxxxxxxx=192168000005	
DNS	xxxxxxxxxxxx	@@DNxxxxxxxxxxxx\r'	xxxxxxxxxxxx:DNS Example)IP=192.168.000.006.:xxxxxxxxxxxx=192168000006	
IP Control Port	XXXXX	@0IpXXXXX\r'	XXXXX:PortNo. 0000~65535	

Description		Command	Remarks	
System Setting	IP Control Auth	ON	@0Ia00\r'	
		OFF	@0Ia01\r'	
	Network Standby	ON	@0Ns00\r'	
		OFF	@0Ns01\r'	
	NTP Server	xxx.xxx.xxx.xxx	@0NPxxxxxxxxxxx\r'	xxxxxxxxxxx:NTP Server IP Example)IP=192.168.000.007.:xxxxxxxxxxx=192168000007 Case of OFF:DISABLE00000
	NTP Cycle	hhmm	@0NChmm\r'	hhmm:00:15~24:00
	Syslog	xxx.xxx.xxx.xxx	@0Slxxxxxxxxxxx\r'	xxxxxxxxxxx:IP Adress Example)IP=192.168.000.007.:xxxxxxxxxxx=192168000007 Case of OFF:DISABLE00000
	Time Zone	xxxxx	@0TZxxxxx\r'	+13:00 ~ -12:00 xx=+0830:+8:30 • Unit : +14:00 ~ -12:00
	Daylight Saving	ON	@0dS00\r'	
		OFF	@0dS01\r'	
	DST Offset	hhmm	@0dohhmm\r'	
	DST Start Date	MMDDhhmm	@0dsMMDDhhmm\r'	
	DST End Date	MMDDhhmm	@0deMMDDhhmm\r'	
	Admin Passwd	xxxxxxxxxxx	@0PDxxxxxxxxxxx\r'	xxxxxxxxxxx:Password A to Z, a to z, 0 to 9 Max12 words
	Operator Password	xxxxxxxxxxx	@0OPxxxxxxxxxxx\r'	xxxxxxxxxxx:Password A to Z, a to z, 0 to 9 Max12 words
	Observer Password	xxxxxxxxxxx	@0Opxxxxxxxxxxx\r'	xxxxxxxxxxx:Password A to Z, a to z, 0 to 9 Max12 words
	ProdMgr Detectable	ON	@0Pd00\r'	
		OFF	@0Pd01\r'	
	ProdMgr Power Ctrl	ON	@0PP00\r'	
		OFF	@0PP01\r'	
Auto Reboot	ON	@0Ar00\r'		
	OFF	@0Ar01\r'		
System Setting Default		@0DESY\r'	System sets All Default	
Utility	Set Time	YYMMDDhhmm	@0DtYYMMDDhhmm\r'	hhmm:hour,24H Example)2013Y06M03D 12:15 1306031215
	Preset Load		@0PVLD\r'	
	Preset Save		@0PVSA\r'	
	Format		@023FOMAT\r'	
IP Remote Authentication	Logout		@0LO\r'	For IP Remote
Other	MAC Address	XXXXXXXXXXXX	@0MAXXXXXXXXXXXXX\r'	XXXXXXXXXXXX:MAC Address

NOTE

※ is State :When Stop, it is possible to set.

※1 Each command does working similar to the button of the unit.

※2 "Track No." is a number of the playback order. The file is managed by "Track No." in serial communications. "Track No." is changed by "File Sort".

※3 Preset is managed by not Preset Name but Preset No. (1-3) in serial communications.

※4 Character-code:ISO/IEC 8859-1

Status Command List

Status request command (Host → This unit)		Status message (this unit → host)				
Request	Command	Ans.	Command	Remarks		
Status	Power Status	@0?PW\r'	Power Mode	On	@0PW00\r'	
				Standby	@0PW01\r'	
				Network Standby	@0PW02\r'	
	Card	@0?CD\r'	Card	No Card	@0CDNC\r'	
				Card In	@0CDCI\r'	
				Card Error	@0CDCE\r'	
				Unformat	@0CDUF\r'	
				Write Protect	@0CDWP\r'	
				Door Open	@0CDDO\r'	
	Disc	@0?CD\r'	Disc	No Disc	@0CDNC\r'	
				Disc In	@0CDCI\r'	
	Status	@0?ST\r'	Rec	D-In Unlock	@0STRU\r'	
				Recording	@0STRE\r'	
				RecPause	@0STRP\r'	
			STOP	STOP	@0STST\r'	
				Cue	@0STCU\r'	
				During AutoCue	@0STAC\r'	
				Scheduled	@0STSH\r'	
			Play	PLAY	@0STPL\r'	
				PLAYPAUSE	@0STPP\r'	
REPEAT PLAY				@0STPR\r'		
PAUSE						
FF				@0STFF\r'		
RWD				@0STRW\r'		
A-B Repeat				@0STAB\r'		
Other	Cue Execute	@0STCE\r'	CUE running state			
	Loading	@0STLD\r'				
	Busy	@0STBY\r'				
	File List	@0STFL\r'				
TrackEdit/Preset	@0STED\r'					
Operation Error	@0STER\r'					

Status request command (Host → This unit)			Status message (this unit → host)			Remarks	
Request	Command	Ans.	Command	Remarks			
Status	Time Mode(Display Mode)	@0?TMOD\r'	Time Mode (Display Mode)	RecRemainTime	@0TMRE\r'		
				TotalTrackNumber	@0TMTN\r'		
				Total Mark Number	@0TMTM\r'		
				Algo	@0TMAG\r'		
				Current Date/Time	@0TMND\r'		
				TrackTime(Elapsed Time)	@0MTT\r'		
				Current Date	@0TMCD\r'		
				Current Time	@0TMCT\r'		
				Recorded Time	@0TMRT\r'		
				Recorded Data	@0TMRD\r'		
				File name	@0TMFN\r'		
				TrackRemainTime	@0TMTR\r'		
				Disc Total Time	@0MTD\r'		
				Recorded Channel	@0TMCH\r'		
				File information	@0TMFI\r'		
				Level Meter	@0TMLV\r'		
				File List	@0TMFL\r'		
				OFF	@0TMOF\r'		
				Play Speed	@0?SP\r'	Play Speed	XXX
Media	@0?MM\r'	Media	USB	@0MMUS\r'			
			SD1	@0MMS1\r'			
			SD2	@0MMS2\r'			
			NET	@0MMNE\r'			
Date Time	@0?Dt\r'	Date Time	YYMMDDhhmm	@0DtYYMMDDhhmm\r'	YYMMDDhhmm:current date		
Rec Monitor	@0?Rm\r'	Rec Monitor	ON	@0Rm00\r'			
			OFF	@0Rm01\r'			
Lock Stat	@0?LS\r'	Lock Stat	Lock	@0LSLK\r'			
			Unlock	@0LSUL\r'			
			SemiLock	@0LSSL\r'			
Track Key select	Total Track Number	@0?Tt\r'		XXXX	@0TtXXXX\r'	XXXX (4 digits):Total Track Number	
				XXX	@0TTXXX\r'	XXX(3 digits):Total Track Number When the number of total tracks is 1000 or more, "FFF" is set (0TTFFF).	
	Track Number	@0?Tr\r'		XXXX	@0TrXXXX\r'	XXXX(4 digits):Track Number	
				XXX	@0TRXXX\r'	XXX(3 digits):Track Number When the number of tracks is 1000 or more, "FFF" is set (0TRFFF).	
	HOT START PLAY No.	(xx:Hot Start No)	@0?HP\r'	HOT START PLAY	XX	@0HPXX\r'	PLAY/PLAY of HOT START No.xx During PAUSE/FF/RWD/REPEAT PLAY PAUSE @0HPxx\r' During normal PLAY, STOP etc @0HP00\r'

Status request command (Host → This unit)			Status message (this unit → host)			Remarks	
Request		Command	Ans.		Command		
Track Key select	E lapse Time		@0?ET\r'	E lapse Time	hhmmss	@0ETHhhmmss\r'	hh:hour (24h display 0~23) mm:minute ss:second
	R emain Time		@0?RM\r'	E lapse Time	hhmmss	@0RMhhhmmss\r'	hh:hour (24h display 0~23) mm:minute ss:second
	R ec R emain Time		@0?RT\r'	E lapse Time	hhmmss	@0RThhhmmss\r'	hh:hour (24h display 0~23) mm:minute ss:second
	F ree	SD1	@0?FE\r'	SD1	XXXXXX	@0FES1XXXXXX\r'	XXXXXX:Capacity (With unit:B/KB/MB/GB/TB)
		SD2	@0?FE\r'	SD2	XXXXXX	@0FES2XXXXXX\r'	XXXXXX:Capacity (With unit:B/KB/MB/GB/TB)
		USB	@0?FE\r'	USB	XXXXXX	@0FEUSXXXXXX\r'	XXXXXX:Capacity (With unit:B/KB/MB/GB/TB)
	S elect Folder		@0?SF\r'	S elect Folder	XXXXXXXXXXXX	@0SFDXXXXXXXXXXXX\r'	D:Media DN700R:USB=2, SD1=1, SD2=4, NET=5 XXX...:Folder Name
	T rack Name	(xxxx:TrackNo (4 digits))	@0?tnxxxx\r'	T rack Name	XXXXXX	@0tnXXXXXX\r'	4 digits
		(xxx:TrackNo (3 digits))	@0?Tnxxx\r'	T rack Name	XXXXXX	@0TnXXXXXX\r'	4 digits
	T rack Size	(xxxx:TrackNo (4 digits))	@0?tsxxxx\r'			@0tsXXXXXX\r'	Track No 4 digits XX...:File Size(KByte) 10KB->@0SZ10\r' (Decimal number) When there is no track or is no current Track or No Card etc. XXXX = 000 1KB=1024byte
		(xxx:TrackNo (3 digits))	@0?Tsxxx\r'			@0TsXXXXXX\r'	Track No 4 digits XX...:File Size(KByte) 10KB->@0SZ10\r' (Decimal number) When there is no track or is no current Track or No Card etc. XXXX = 000 1KB=1024byte
	C urrent Track Len		@0?tl\r'	C urrent Track Len	MMMSFF	@0tIMMSFF\r'	
	T ext Information:File		@0?T1\r'	T ext Information:File	XXXX	@0T1XXXX\r'	0-255 character
	T ext Information:Artist		@0?T2\r'	T ext Information:Artist	XXXX	@0T2XXXX\r'	0-255 character
	T ext Information:Album		@0?T3\r'	T ext Information:Album	XXXX	@0T3XXXX\r'	0-255 character
T otal Folder Number		@0?Tf\r'	T otal Folder Number		@0TfXXXX\r'		
F older Name		@0?Fnxxxx\r'	F older Name		@0FnXXXXXX\r'	Four folder number digit specification XXXXXX:Folder name 256 words	

Status request command (Host → This unit)			Status message (this unit → host)			Remarks	
Request	Command	Ans.	Command	Remarks			
Track Key select	Play Track Algo/File	CH	@0?ch\r'	CH	STEREO MONO	@0chST\r' @0chMO\r'	
		Algo	@0?af\r'	Algo	PCM	@0afPMXX\r'	XX:Bit length
					MP3	@0afM3XXX\r'	XXX:bps
					WAV	@0afWVXX\r'	XX:Bit length
					AIFF	@0afAIXX\r'	XX:Bit length
					AAC	@0afAAXXX\r'	XXX:bps
		FS	@0?fs\r'	FS	XX	@0fsXX\r'	XX: 96KHz=96, 48KHz=48, 44.1KHz=44 The kind of the setting is the same as the selection of Menu.
		Artist	@0?at\r'	Artist	XXX	@0atxxx\r'	xxx:Artist Max 64 words
	Title	@0?ti\r'	Title	XXX	@0tixxx\r'	xxx:Title Max 64 words	
	Album	@0?al\r'	Album	XXX	@0alxxx\r'	xxx:Album Max 64 words	
	Hot Start Set	nn:Hot Start No	@0?Hsnn\r'	Hot Start Set	@0Hsnnxxxxxx:HHHmms\r'	xxx:Fullpath of Track :Separator HHHmms:Time	
			@0?HSnn\r'	Hot Start Set	@0HSnnxxHHHmms\r'	XXX(3 digits):Total Track Number HHHmms:Time When the number of total tracks is 1000 or more, "FFF" is set (0HSnnFFFHHHmms).	
	Rec Volume	@0?RV\r'	Rec Volume	LLRR	@0RVLLRR\r'	LL:Left volume value, RR:Right volume value -60dB=60, MUTE=MU	
	Pitch	@0?PT\r'	PITCH	XXXX	@0PTSSXXX\r'	SS:ON/OFF, ON:SS=ON, OFF:SS=OF XXXX:Pitch Value First Sign=0:Plus/1:Minus Second Pitch 10(0~9) Third Pitch 1(0~9) Fourth Pitch 0.1(0~9) Example)ON, :+16.0%:SSXXX=ON0160 +16.0~-16.0% Range:0.1%	
	Total Mark Number	@0?Tm\r'	Total Mark Number	XX	@0TmXX\r'	XX:Total Mark number	
Mark Time	nn:Mark No.	@0?Mtn\r'	Mark Time	hhmmssff	@0Mthmmssff\r'	hh:hour (24h display 0~23) mm:minute ss:second ff:frame	
Total Program List Number	@0?tP\r'	Total Program List Number	XX	@0tPXX\r'	XX:Number of total registration(~99)		
Program List File Name	nn:List No.	@0?plnn\r'	Program List File Name	XXXXXXXXXXXXX	@0plXXXXXXXXXXXXX\r'	XXXXXX:File name	
Update List	@0?UL\r'	Update List	No change	@0UL00\r'	When Folder List is changed.		
			Change	@0UL01\r'	When Folder List is not changed.		
Preset General	Preset Setting	@0?PS\r'	Preset	Preset1	@0PS01\r'		
				Preset2	@0PS02\r'		
				Preset3	@0PS03\r'		
Preset Title	(x:Preset No)	@0?PNx\r'	Preset Name	xxxxxxx	@0PNxxxxxxx\r'	n:Preset No xxxxxx:Preset Name	
Shift Mode	@0?Sm\r'	Shift Mode	Momentary	@0SmMO\r'			
			Lock	@0SmLK\r'			

Status request command (Host → This unit)			Status message (this unit → host)			Remarks	
Request		Command	Ans.	Command			
Preset General	Power On Mode		Power On Mode	Resume Play	@0PORM\r'		
				Play First	@0POPF\r'		
				STOP	@0POST\r'		
				REC	@0PORE\r'		
Preset Rec	Dual Rec		Dual Rec	Off	@0dROF\r'		
				SD1	@0dRS1\r'		
				SD2	@0dRS2\r'		
				USB	@0dRUS\r'		
	Relay Rec		Relay Rec	Off	@0rROF\r'		
				SD1	@0rRS1\r'		
				SD2	@0rRS2\r'		
				USB	@0rRUS\r'		
	Rec level Type		@0?RI\r'	Rec level Type	Master/bal	@0RIMA\r'	
	ALC(Rec level)		@0?RL\r'	Rec level	Separate L/R	@0RILR\r'	
					Manual	@0RLMA\r'	
					ALC(Separate)	@0RLSE\r'	
One Touch Rec		@0?OR\r'	One Touch Rec	ALC(Mix)	@0RLMI\r'		
				On	@0OR00\r'		
InputSelect		@0?IN\r'	InputSelect	Off	@0OR01\r'		
				UNBALANCE	@0INUB\r'		
Rec Format		@0?AF\r'	Algo	BALANCE	@0INBA\r'		
				Coaxial(Digi-Unbal)	@0INDI\r'		
				AES/EBU(Digi-Bal)	@0INDB\r'		
				PCM-XX	@0AFPMXX\r'	XX :Bit length	
Rec Channel		@0?CH\r'	CH	MP3-XXX	@0AFM3XXX\r'	XXX:bps 320Kbps=320, 64Kbps=064 etc The kind of the setting is the same as the selection of Menu.	
				STEREO	@0CHST\r'		
				L-MONO	@0CHML\r'		
Sample rate		@0?FS\r'	FS	LR-MONO	@0CHMX\r'		
				XX	@0FSXX\r'	XX: 96KHz=96, 48KHz=48, 44.10KHz=44 The kind of the setting is the same as the selection of Menu.	
PreRec		@0?PR\r'	PreRec	OFF	@0PR\r'		
				XX (sec)	@0PRxS\r'	x sec:x= 1 ~ 5 (Sec)	
A.Track	Time	@0?AT\r'	A.TrackTime	HHMM	@0ATHHMM\r'	HH:hour MM:minute Off=0000, 1min = 0001,5min = 0005 30min = 0030,1hour = 0100 The kind of the setting is the same as the selection of Menu.	
AutoMark	On/Off	@0?AM\r'	AutoMark	ON	@0AM00\r'		
				OFF	@0AM01\r'		
Silent Skip	On/Off	@0?SS\r'	S.SKIP	ON	@0SS00\r'		
				OFF	@0SS01\r'		
Silent Time		@0?SC\r'	Silent Time	XX	@0SCXX\r'	XX:sec	

Status request command (Host → This unit)			Status message (this unit → host)			Remarks	
Request		Command	Ans.		Command		
Preset Rec	Silent Level		@0?SL\r'	Silent Level	XX	@0SLXX\r'	XX: -20dB=20, -25dB=25 etc The kind of the setting is the same as the selection of Menu.
Preset Play	Play Range	On/Off	@0?pR\r'	Play Range	All	@0pRAL\r'	
					Folder	@0pRFD\r'	
	Play Mode		@0?PM\r'	Play Mode	Single Play	@0PMSP\r'	
					Continuous	@0PMCN\r'	
	Random	On/Off	@0?RN\r'	Random	ON	@0RN00\r'	
					OFF	@0RN01\r'	
	Program Play/Normal Play		@0?PG\r'	Program Play/Normal Play	Normal Play	@0PG00\r'	
					Program Play	@0PG01\r'	
	Finish Mode (Shingle Mode)		@0?FM\r'	Finish Mode	STOP	@0FMST\r'	
					Next	@0FMNT\r'	
					Recue	@0FMRC\r'	
	Repeat Mode		@0?RE\r'	Repeat Mode	ON	@0RE00\r'	
					OFF	@0RE01\r'	
	Auto Cue	ON/OFF	@0?AC\r'	Auto Cue	OFF	@0AC00\r'	
				XX	@0ACXX\r'	xx:Auto Cue Level Example) -48dB:xx=48	
SKIP BACK		@0?SB\r'	SKIP BACK	XXX(time)	@0SBXXX\r'	xxx=005:0.5sec...	
Search Mode		@0?sM\r'	Search Mode	Normal	@0sMNO\r'		
				Silent	@0sMSL\r'		
Auto Fade In		@0?FI\r'	Fade In	XXX(time)	@0FIXXX\r'	xx:Set time Off:xx = 00 0.5sec:xx = 05, 1.0sec:xx = 10, 1.5sec:xx = 15	
Auto Fade Out		@0?FO\r'	Fade Out	XXX(time)	@0FOXXX\r'	xx:Set time Off:xx = 00 0.5sec:xx = 05, 1.0sec:xx = 10, 1.5sec:xx = 15	
Start Delay		@0?sD\r'	Start Delay	xxx	@0sDxxx\r'	xxx:set time(10msec) Off:xxx = 000 100msec:xxx = 010, 200msec:xxx = 020, 300msec:xxx = 030	
EOM(End Of Message)		@0?ED\r'	EOM(End Of Message)	XX(Time)	@0EDXX\r'	xx=OF:Off, 00:0sec, 05:5sec • Unit : to 60sec.	
Master Key (Key Con Pitch)		@0?KY\r'	Key Control	ON	@0KY00\r'		
				OFF	@0KY01\r'		
Preset Display	Time Display		@0?TD\r'	Time Display	HH:MM:SS	@0TDHMS\r'	
					MMM:SS:FF	@0TDMSF\r'	
	File Sort		@0?FR\r'	File Sort	Date/Time	@0FRDA\r'	
					Alphabetical	@0FRAL\r'	
	Dimmer		@0?DM\r'	Dimmer	ON	@0DM00\r'	
					OFF	@0DM01\r'	
	Display Dimmer		@0?DD\r'	Display Dimmer	100%	@0DD00\r'	
				75%	@0DD01\r'		
				50%	@0DD02\r'		
				25%	@0DD03\r'		
				0%	@0DD04\r'		

Status request command (Host → This unit)			Status message (this unit → host)		
Request	Command	Ans.	Command	Remarks	
Preset Display	LED Dimmer	@0?LD\r'	LED Dimmer	100% @0LD00\r' 75% @0LD01\r' 50% @0LD02\r' 25% @0LD03\r'	
	Screen Saver	@0?Ss\r'	Screen Saver	ON @0Ss00\r' OFF @0Ss01\r'	
Preset Remote	Fadar Start	@0?FD\r'	Fedar Start	Play @0FDPL\r'	
				PlayPause @0FDPU\r'	
				PlayNext @0FDNE\r'	
				Play&Lock @0FDLO\r'	
				Play&LockPause @0FDLP\r'	
				Play&LockNext @0FDLN\r'	
				StartPause @0FDSP\r'	
				StartPauseTrack @0FDST\r'	
				Manual Track @0FDMT\r'	
				Parallel Port	@0?PA\r'
Preset Other	KeyBoard	@0?KB\r'	KeyBoard	Englaish(US) @0KBUS\r'	
				Englaish(UK) @0KBUK\r'	
				France @0KBFR\r'	
				German @0KBGE\r'	
				Italia @0KBIT\r'	
				Spanish @0KBSP\r'	
				Nederland @0KBNE\r'	
				Swedish @0KBSW\r'	
				Japanese @0KBJP\r'	
				Archive	Archive Mode
AUTO @0ARAT\r'					
Schedule @0ARSC\r'					
Schedule	@0?as\r'	Schedule	DayOfWeek @0asDWxxxxxxxhhmm\r'	xxxxxx:Setting on a day of the week The initial ("S", "M", "T", "W", "T", "F", "S") of the day of the week to reserve is connected, and the day of the week which is not reserved is connected by "_." hhmm:Time set If it is "Every time", it is displayed by "***". Example) Every day 12:15 SMTWTFS1215 Example) It starts in 15 minutes every hour except Wednesday and Friday. SMT_T_S**15	
			DateTime @0asDTYYMMDDhhmm\r'	YYMMDDhhmm:Set Time(Year,Month,Day,Hour,M inute) If it is "Every month" or "Every year", it is displayed by "***".. Example) 2012Y6M3D12:15 1206031215 Example) 2012Y Every month3D12:15	

Status request command (Host → This unit)			Status message (this unit → host)			Remarks	
Request	Command	Ans.	Command	Ans.			
Archive	Archive Server IP	@0?AI\r'	Archive Server IP	xxx.xxx.xxx.xxx	@0AIxxxxxxxxxxxx\r'	xxxxxxxxxxxx:Archive Server IP Example)IP = 192.168.000.007.:xxxxxxxxxx xx=192168000007	
	Archive Folder	@0?AO\r'	Archive Folder	XXXXXXXXXXXX	@0AOXXXXXXXXXXXX\r'	XXXXXXXXXXXX:Archive Folder Name	
	Archive User Name	@0?AU\r'	Archive User Name	XXXXXXXXXXXX	@0AUXXXXXXXXXXXX\r'	XXXXXXXXXXXX:Archive User Name	
	Archive Password	@0?AP\r'	Archive Password	XXXXXXXXXXXX	@0APXXXXXXXXXXXX\r'	XXXXXXXXXXXX:Archive Password	
	Auto Deletion	@0?AD\r'	Auto Deletion	OFF XXh	@0ADOF\r' @0ADXX\r'	XX h(set time 1h= 01) 1h, 3h, 6h, 12h, 24h	
	Clear After Archive	@0?CA\r'	Clear After Archive	ON OFF	@0CA00\r' @0CA01\r'		
Rec Timer	Rec Timer	Timer No:XX	@0?ShXX\r'	Rec Timer	DayOfWeek	@0ShDWxxxxxxxxHHMMhmmXXXX\r'	XX:Reserve No → 01-30 xxxxxx:Setting on a day of the week The initial ("S", "M", "T", "W", "T", "F", "S") of the day of the week to reserve is connected, and the day of the week which is not reserved is connected by "_." hhmm:Time set If it is "Every time", it is displayed by "***". Example) Every day 12:15 SMTWTFS1215 Example) It starts in 15 minutes every hour except Wednesday and Friday. SMT_T_S**15 hhmm:Recording time=hour, minute XXXX:UserArea(Min words number=0, Max words number=32words)
					DateTime	@0ShDTYYMMDDHHMMhmmXXXX\r'	XX:Reserve No → 01-30 YYMMDDhhmm:Set Time(Year,Month,Day,Hour,M inute) If it is "Every month" or "Every year", it is displayed by "***".. Example) 2012Y6M3D12:15 1206031215 Example) 2012Y Every month3D12:15 hhmm:Recording Time= heure, minute XXXX:UserArea(Min words=0, Max Words=32Words)

Status request command (Host → This unit)				Status message (this unit → host)			
Request		Command	Ans.	Command		Remarks	
Play Timer	Play Timer	Timer No:XX	@0?TPXX\r'	Play Timer	DayOfWeek	@0TPDWxxxxxxxxHHMMFFFF\r'	XX:Reserve No→ 01-30 xxxxxx:Setting on a day of the week The initial ("S", "M", "T", "W", "T", "F", "S") of the day of the week to reserve is connected, and the day of the week which is not reserved is connected by "_." hhmm:Time set If it is "Every time", it is displayed by "***". Example) Every day 12:15 SMTWTFS1215 Example) It starts in 15 minutes every hour except Wednesday and Friday. SMT_T_S**15 FFFFFFFF:file name(full path)*4
					DateTime	@0TPDTYYMMDDHHMMFFFF\r'	XX:Reserve No→ 01-30 YYMMDDhhmm:Set Time(Year,Month,Day,Hour,M minute) If it is "Every month" or "Every year", it is displayed by "***".. Example) 2012Y6M3D12:15 1206031215 Example) 2012Y Every month3D12:15 FFFFFFFF:file name(full path)*4
	Current Timer		@0?Ct\r'	Current Timer	Rec Timer	@0CtRExx\r'	xx:Timer No. (01~30)
					Play Timer	@0CtPLxx\r'	xx:Timer No. (01~30)
	Reserved Timer		@0?Rt\r'	Reserved Timer	Rec Timer	@0RtRExx\r'	xx:Timer No. (01~30)
				Play Timer	@0RtPLxx\r'	xx:Timer No. (01~30)	
System Setting	Play Timer Priority		@0?tp\r'	Play Timer Priority	ON	@0tp00\r'	
					OFF	@0tp01\r'	
	Rec Folder		@0?Rf\r'	Rec Folder	Current	@0RfCU\r'	
					Fixed	@0RfFXNNNNNNNN\r'	NNNNNNN:Fullpath
	Signal Pass Thru		@0?Sp\r'	Signal Pass Thru	ON	@0Sp00\r'	
					OFF	@0Sp01\r'	
	User area		@0?US\r'	User area	ON	@0US00\r'	
			@0?UA\r'		OFF	@0US01\r'	
					xxxxxxxxxxxxxxxx	@0UAxxxxxxxxxxxxxxxx\r'	xxxxxxxxxxxxxxxx:User Area name(0-32 words) 0 word:no set vlue
	File name form		@0?Ff\r'	File name form	MN_DT_UA	@0FfMDU\r'	
					MN_UA_DT	@0FfMUD\r'	
					DT_MN_UA	@0FfDMU\r'	
					DT_UA_MN	@0FfDUM\r'	
				UA_MN_DT	@0FfUMD\r'		
				UA_DT_MN	@0FfUDM\r'		
Mono		@0?MO\r'	Mono	ON	@0MO00\r'		
				OFF	@0MO01\r'		

Status request command (Host → This unit)			Status message (this unit → host)			
Request	Command	Ans.	Command	Remarks		
System Setting	Digital Out Fs	@0?dF\r'	Digital Out Fs	AUTO 44.1KHz 48KHz Ext(AES)	@0dFAT\r' @0dF44\r' @0dF48\r' @0dFEX\r'	
	Line/Mic LCh	@0?LML\r'	Line/Mic LCh	Line Mic	@0LMLLN\r' @0LMLMC\r'	
	Line/Mic RCh	@0?LMR\r'	Line/Mic RCh	Line Mic	@0LMRLN\r' @0LMRMC\r'	
	Phantom LCh	@0?PhL\r'	Phantom LCh	ON OFF	@0PhL00\r' @0PhL01\r'	
	Phantom RCh	@0?PhR\r'	Phantom RCh	ON OFF	@0PhR00\r' @0PhR01\r'	
	Mic In Sens L-Ch	@0?MsL\r'	Mic In Sens L-Ch	XX	@0MsLXX\r'	XX:L-Ch Mic Senc value (XX:16-40)
	Mic In Sens R-Ch	@0?MsR\r'	Mic In Sens R-Ch	XX	@0MsRXX\r'	XX:R-Ch Mic Senc value (XX:16-40)
	Volume Input	@0?VI\r'	Volume Input	Fixed Variable	@0VIFX\r' @0VIVA\r'	
	Ref (XLR/RCA) (FS Reference)	@0?Fr\r'	Ref (XLR/RCA) (FS Reference)	XX	@0FrXX\r'	XX:Set value(dBu) XX=24:XLR=+24dBu / RCA=+10dBV XX=20:XLR=+20dBu / RCA=+6dBV XX=18:XLR=+18dBu / RCA=+4dBV
	Input Trim L	@0?ItL\r'	Input Trim L	XXX	@0ItLXXX\r'	XXX:Trim setting value(+2.0dB~ -2.0dB) XXX=+20:+2.0
	Input Trim R	@0?ItR\r'	Input Trim R	XXX	@0ItRXXX\r'	XXX:Trim setting value(+2.0dB~ -2.0dB) XXX=+20:+2.0
	Output Trim L	@0?OtL\r'	Output Trim L	XXX	@0OtLXXX\r'	XXX:Trim setting value(+2.0dB~ -2.0dB) XXX=+20:+2.0
	Output Trim R	@0?OtR\r'	Output Trim R	XXX	@0OtRXXX\r'	XXX:Trim setting value(+2.0dB~ -2.0dB) XXX=+20:+2.0
	Time Form	@0?TF\r'	Time Form	12h 24h	@0TF12\r' @0TF24\r'	
	DateForm	@0?DF\r'	DateForm	MDY DMY YMD	@0DFMD\r' @0DFDM\r' @0DFYM\r'	
	Display Contrast (Brightness)	@0?BN\r'	Display Contrast (Brightness)	XX	@0BNXX\r'	XX:01-10
	Language	@0?LN\r'	Language	English Japan	@0LNUS\r' @0LNJP\r'	
	Machine Name	@0?MN\r'	Machine Name	xxxxxxxxxxxx	@0MNxxxxxxxxxxxx\r'	xxxxxxxxxxxx:Machine Name A to Z, a to z, 0 to 9 Max12 words
	IP Address	@0?IP\r'	IP Address	xxx.xxx.xxx.xxx	@0IPxxxxxxxxxxxx\r'	xxxxxxxxxxxx:IP Address Example)IP = 192.168.000.002.:xxxxxxxxxx xx=192168000002
	Sub net mask	@0?SM\r'	Sub net mask	xxx.xxx.xxx.xxx	@0SMxxxxxxxxxxxx\r'	xxxxxxxxxxxx:Sub net mask Example)Sub net mask = 255.255.255.000.: xxxxxxxxxxxx=255255255000
Gateway	@0?GW\r'	Gateway	xxx.xxx.xxx.xxx	@0GWxxxxxxxxxxxx\r'	xxxxxxxxxxxx:Gateway IP Example)IP = 192.168.000.005.:xxxxxxxxxx xx=192168000005	

Status request command (Host → This unit)			Status message (this unit → host)			Remarks
Request	Command	Ans.	Command	Ans.		
System Setting	DNS	@0?DN\r'	DNS	xxx.xxx.xxx.xxx	@@DNxxxxxxxxxxxx\r'	xxxxxxxxxxxx:DNS Example)IP = 192.168.000.006.:xxxxxxxxxx xx=192168000006
	IP Control Port	@0?Ip\r'	IP Control Port	XXXXX	@0IpXXXX\r'	XXXXX:PortNo. 00000~65535
	IP Control Auth	@0?Ia\r'	IP Control Auth	ON OFF	@0Ia00\r' @0Ia01\r'	
	Network Standby	@0?Ns\r'	Network Standby	ON OFF	@0Ns00\r' @0Ns01\r'	
	NTP Server	@0?NP\r'	NTP Server	xxx.xxx.xxx.xxx	@0NPxxxxxxxxxxxx\r'	xxxxxxxxxxxx:NTP Server IP Example)IP = 192.168.000.007.:xxxxxxxxxx xx=192168000007 OFF:DISABLE00000
	NTP Cycle	@0?NC\r'	NTP Cycle	hhmm	@0NChhmm\r'	hhmm:00:15~24:00
	Syslog	@0?SI\r'	Syslog	xxx.xxx.xxx.xxx	@0SIxxxxxxxxxxxx\r'	xxxxxxxxxxxx:IP Address Example)IP = 192.168.000.007.:xxxxxxxxxx xx=192168000007 OFF:DISABLE00000
	Time Zone	@0?TZ\r'	Time Zone	xxxxx	@0TZxxxx\r'	+13:00 ~ -12:00 xx=+0830:+8:30 • Unit : +14:00 ~ -12:00
	Daylight Saving	@0?dS\r'	Daylight Saving	ON OFF	@0dS00\r' @0dS01\r'	
	DST Offset	@0?do\r'	DST Offset	hhmm	@0dohhmm\r'	hhmm:00:00~06:00(15min Step)
	DST Start Date	@0?ds\r'	DST Start Date	MMDDhhmm	@0dsMMDDhhmm\r'	
	DST End Date	@0?de\r'	DST End Date	MMDDhhmm	@0deMMDDhhmm\r'	
	ProdMgr Detectable	@0?Pd\r'	ProdMgr Detectable	ON OFF	@0Pd00\r' @0Pd01\r'	
	ProdMgr Power Ctrl	@0?PP\r'	ProdMgr Power Ctrl	ON OFF	@0PP00\r' @0PP01\r'	
	Auto Reboot	@0?Ar\r'	Auto Reboot	ON OFF	@0Ar00\r' @0Ar01\r'	
	Card Cheak	@0?CK\r'	Card Cheak	XX.XXX (MB/S)	@0CKXXXX\r'	XX.XXX WriteSpeed(MB/S)
	Version etc	Version	@0?VN\r'	Version	xxxxxxx:Version No(8 digits) mmmmmmm: model name	@0VNxxxxxxxxmmmmmm\r'

Status request command (Host → This unit)			Status message (this unit → host)			Remarks	
Request		Command	Ans.	Command			
Update (for RCF400S Update)	Update File ?		@0?UF\r'	Update File ?	OK NG	@0UFOK\r' @0UFNG\r'	
	Update start		@0?UD\r'	Update Data	xxxxx NG	@0UDXXXXX\r' @0UD\r'	XXXX:Update file information
Update (For unit Update) (For IP Remote)	Update File data send start	Update File size:xxxxxxx	@0?UTxxxxxxx\r'	Update File transfer start	OK NG	@0UTOK\r' @0UTNG\r'	for IP Remote STOP mode only NG is returned excluding STOP.
	Password Login	xx:User ID yyyy>Password	@0?Llxx:yyyyyy\r'	Password Login	OK NG	@0LIOK\r' @0LING\r'	for IP Remote xx:User ID xx = AD :Admin for IP Remote
IP Remote authentication							
Other	MAC Address		@0?MA\r'	MAC Address	XX.XXX (MB/S)	@0MAXXXXXXXXXXX\r'	XXXXX:MAC Address

NOTE

※ is State :When Stop, it is possible to set.

※2 "Track No." is a number of the playback order. The file is managed by "Track No." in serial communications. "Track No." is changed by "File Sort".

※3 Preset is managed by not Preset Name but Preset No. (1-3) in serial communications.

※4 Character-code:ISO/IEC 8859-1

Status Information List

Status information (this unit → host)					Remarks
	Ans.		Command		
When current media change.	Card	Card	No Card	@0CDNC\r'	
			Card In	@0CDCI\r'	
			Card Error	@0CDCE\r'	
			Unformed	@0CDUF\r'	
			Write Protect	@0CDWP\r'	
	Disc	Disc	No Disc	@0CDNC\r'	
			Disc In	@0CDCI\r'	
			Disc Error	@0CDCE\r'	
When status change.	Status	Rec	D-In Unlock	@0STRU\r'	
			Recording	@0STRE\r'	
			RecPause	@0STRP\r'	
		STOP	STOP	@0STST\r'	
			Cue	@0STCU\r'	
			during AutoCue	@0STAC\r'	
			Scheduled	@0STSH\r'	
		Play	PLAY	@0STPL\r'	
			PLAYPAUSE	@0STPP\r'	
			REPEAT PLAY PAUSE	@0STPR\r'	
			FF	@0STFF\r'	
			RWD	@0STRW\r'	
			A-B Repeat	@0STAB\r'	
			Cue Execute	@0STCE\r'	CUE state
		Other	Loading	@0STLD\r'	
			Busy	@0STBY\r'	
			File List	@0STFL\r'	
			TrackEdit/Preset	@0STED\r'	
			Operation Error	@0STER\r'	
	Time Mode(Display Mode)	Time Mode(Display Mode)	RecRemainTime	@0TMRE\r'	
			TotalTrackNumber	@0TMTN\r'	
			Total Mark Number	@0TMTM\r'	
			Algo	@0TMAG\r'	
			Current Date/Time	@0TMND\r'	
			TrackTime(Elapsed Time)	@0TMTT\r'	
			Current Date	@0TMCD\r'	
			Current Time	@0TMCT\r'	
			Recorded Time	@0TMRT\r'	
			Recorded Data	@0TMRD\r'	
			File name	@0TMFN\r'	
			TrackRemainTime	@0TMTR\r'	
			Disc Total Time	@0TMTD\r'	
			Recorded Channel	@0TMCH\r'	
			File information	@0TMFI\r'	
			Level Meter	@0TMLV\r'	
			File List	@0TMFL\r'	
OFF			@0TMOF\r'		

Status information (this unit → host)				Command	Remarks
	Ans.				
When current media change.	Media	Media	USB	@0MEUS\r'	
			SD1	@0MES1\r'	
			SD2	@0MES2\r'	
			NET	@0MENE\r'	
When current track change.	Cue Track No.	XXXX		@0CnXXXX\r'	XXXX:Track No.
When total folder number change.	Total Folder Number	XXXX		@0TfXXXX\r'	XXXX:Total Folder number
When folder change.	Select Folder	XXXXXXXXXXXX		@0SFXXXXXXXXXXXX\r'	XX...:Folder name
When total track number change.	Total Track Number	XXXX		@0TtXXXX\r'	4 digits
When error occurs		Error		@0ERnnxxx\r'	"ss:display Time(00~99) 00:Until Error of Status finish 01:1Second 02:2S 03:3S xxx...:Message (In the number of words, 1-30 words and the codes are ISO/IEC 8859-1)"

License

ENGLISH

This section describes software license used for DN-700R/RC-F400S. To maintain the correct content, the original (English) is used.

FRANÇAIS

Cette section concerne la licence du logiciel utilisé avec le lecteur DN-700R/RC-F400S.

Le document d'origine (en anglais) est utilisé afin d'assurer l'exactitude du contenu.

ESPAÑOL

Esta sección describe el contenido de la licencia del software para el DN-700R/RC-F400S.

Para mantener el contenido correcto, se utiliza el original (Inglés).

DEUTSCH

Dieser Abschnitt beschreibt die für den DN-700R/RC-F400S verwendete Software-Lizenz.

Um den korrekten Inhalt zu erhalten, wird das Original (Englisch) verwendet.

ITALIANO

Questa sezione descrive la licenza software usata per il DN-700R/RC-F400S.

Per mantenere il giusto contenuto, viene usata la forma originale (in inglese).

SVENSKA

Denna sektion beskriver programvarulicenserna som används för DN-700R/RC-F400S.

För att behålla det korrekta innehållet används originalspråket (engelska).

Copyright (c) 1990-2003

Wada Laboratory, the University of Tokyo. All rights reserved.

Copyright (c) 2003-2004

Electronic Font Open Laboratory (/efont/). All rights reserved.

Redistribution and use in source and binary forms, with or without modification, are permitted provided that the following conditions are met:

1. Redistributions of source code must retain the above copyright notice, this list of conditions and the following disclaimer.
2. Redistributions in binary form must reproduce the above copyright notice, this list of conditions and the following disclaimer in the documentation and/or other materials provided with the distribution.
3. Neither the name of the Wada Laboratory, the University of Tokyo nor the names of its contributors may be used to endorse or promote products derived from this software without specific prior written permission.

THIS SOFTWARE IS PROVIDED BY WADA LABORATORY, THE UNIVERSITY OF TOKYO AND CONTRIBUTORS "AS IS" AND ANY EXPRESS OR IMPLIED WARRANTIES, INCLUDING, BUT NOT LIMITED TO, THE IMPLIED WARRANTIES OF MERCHANTABILITY AND FITNESS FOR A PARTICULAR PURPOSE ARE DISCLAIMED. IN NO EVENT SHALL THE LABORATORY OR CONTRIBUTORS BE LIABLE FOR ANY DIRECT, INDIRECT, INCIDENTAL, SPECIAL, EXEMPLARY, OR CONSEQUENTIAL DAMAGES (INCLUDING, BUT NOT LIMITED TO, PROCUREMENT OF SUBSTITUTE GOODS OR SERVICES; LOSS OF USE, DATA, OR PROFITS; OR BUSINESS INTERRUPTION) HOWEVER CAUSED AND ON ANY THEORY OF LIABILITY, WHETHER IN CONTRACT, STRICT LIABILITY, OR TORT (INCLUDING NEGLIGENCE OR OTHERWISE) ARISING IN ANY WAY OUT OF THE USE OF THIS SOFTWARE, EVEN IF ADVISED OF THE POSSIBILITY OF SUCH DAMAGE.



SDHC Logo is a trademark of SD-3C, LLC.

[NFLC]

(1) This product is installed with "NetFront Living Connect" home network interconnection software made by ACCESS Co., Ltd.

(2) Logos specified by ACCESS Co., Ltd. (ACCESS company logo and NetFront logo)

(3) ACCESS and NetFront are the trademarks or registered trademarks of ACCESS Co., Ltd in Japan and other countries.

(4) Copyright (c) 2012 ACCESS CO., LTD.

[GD]

Portions copyright 1994, 1995, 1996, 1997, 1998, 1999, 2000, 2001, 2002, 2003, 2004 by Cold Spring Harbor Laboratory. Funded under Grant P41-RR02188 by the National Institutes of Health.

Portions copyright 1996, 1997, 1998, 1999, 2000, 2001, 2002, 2003, 2004 by Boutell.Com, Inc.

Portions relating to GD2 format copyright 1999, 2000, 2001, 2002, 2003, 2004 Philip Warner.

Portions relating to PNG copyright 1999, 2000, 2001, 2002, 2003, 2004 Greg Roelofs.

Portions relating to gdttf.c copyright 1999, 2000, 2001, 2002, 2003, 2004 John Ellson (ellson@graphviz.org).

Portions relating to gdft.c copyright 2001, 2002, 2003, 2004 John Ellson (ellson@graphviz.org).

Portions relating to JPEG and to color quantization copyright 2000, 2001, 2002, 2003, 2004, Doug Becker and copyright (C) 1994, 1995, 1996, 1997, 1998, 1999, 2000, 2001, 2002, 2003, 2004 Thomas G. Lane. This software is based in part on the work of the Independent JPEG Group. See the file README-JPEG.TXT for more information.

Portions relating to GIF compression copyright 1989 by Jef Poskanzer and David Rowley, with modifications for thread safety by Thomas Boutell.

Portions relating to GIF decompression copyright 1990, 1991, 1993 by David Koblas, with modifications for thread safety by Thomas Boutell.

Portions relating to WBMP copyright 2000, 2001, 2002, 2003, 2004 Maurice Szmurlo and Johan Van den Brande.

Portions relating to GIF animations copyright 2004 Jaakko Hyvatti (jaakko.hyvatti@iki.fi)

Permission has been granted to copy, distribute and modify gd in any context without fee, including a commercial application, provided that this notice is present in user-accessible supporting documentation.

This does not affect your ownership of the derived work itself, and the intent is to assure proper credit for the authors of gd, not to interfere with your productive use of gd. If you have questions, ask. "Derived works" includes all programs that utilize the library. Credit must be given in user-accessible documentation.

This software is provided "AS IS." The copyright holders disclaim all warranties, either express or implied, including but not limited to implied warranties of merchantability and fitness for a particular purpose, with respect to this code and accompanying documentation.

Although their code does not appear in the current release, the authors also wish to thank Hutchison Avenue Software Corporation for their prior contributions.

ACCESS™ NetFront™ Living Connect

(1)"This product contains NetFront Living Connect of ACCESS CO., LTD."

(2)"ACCESS and NetFront are trademarks or registered trademarks of ACCESS CO., LTD. in Japan and in other countries."

(3)"Copyright (c) 2012 ACCESS CO., LTD."

expat

Copyright (c) 1998, 1999, 2000 Thai Open Source Software Center Ltd

Permission is hereby granted, free of charge, to any person obtaining a copy of this software and associated documentation files (the "Software"), to deal in the Software without restriction, including without limitation the rights to use, copy, modify, merge, publish, distribute, sublicense, and/or sell copies of the Software, and to permit persons to whom the Software is furnished to do so, subject to the following conditions:

The above copyright notice and this permission notice shall be included in all copies or substantial portions of the Software.

THE SOFTWARE IS PROVIDED "AS IS", WITHOUT WARRANTY OF ANY KIND, EXPRESS OR IMPLIED, INCLUDING BUT NOT LIMITED TO THE WARRANTIES OF MERCHANTABILITY, FITNESS FOR A PARTICULAR PURPOSE AND NONINFRINGEMENT.

IN NO EVENT SHALL THE AUTHORS OR COPYRIGHT HOLDERS BE LIABLE FOR ANY CLAIM, DAMAGES OR OTHER LIABILITY, WHETHER IN AN ACTION OF CONTRACT, TORT OR OTHERWISE, ARISING FROM, OUT OF OR IN CONNECTION WITH THE SOFTWARE OR THE USE OR OTHER DEALINGS IN THE SOFTWARE.

md5

/* Copyright (C) 1991-2, RSA Data Security, Inc. Created 1991. All rights reserved.

License to copy and use this software is granted provided that it is identified as the "RSA Data Security, Inc. MD5 Message-Digest Algorithm" in all material mentioning or referencing this software or this function.

License is also granted to make and use derivative works provided that such works are identified as "derived from the RSA Data Security, Inc. MD5 Message-Digest Algorithm" in all material mentioning or referencing the derived work.

RSA Data Security, Inc. makes no representations concerning either the merchantability of this software or the suitability of this software for any particular purpose. It is provided "as is" without express or implied warranty of any kind.

These notices must be retained in any copies of any part of this documentation and/or software.

*/

zlib

/* zlib.h -- interface of the 'zlib' general purpose compression library version 1.2.7, May 2nd, 2012

Copyright (C) 1995-2012 Jean-loup Gailly and Mark Adler

This software is provided 'as-is', without any express or implied warranty. In no event will the authors be held liable for any damages arising from the use of this software.

Permission is granted to anyone to use this software for any purpose, including commercial applications, and to alter it and redistribute it freely, subject to the following restrictions:

1. The origin of this software must not be misrepresented; you must not claim that you wrote the original software. If you use this software in a product, an acknowledgment in the product documentation would be appreciated but is not required.
2. Altered source versions must be plainly marked as such, and must not be misrepresented as being the original software.
3. This notice may not be removed or altered from any source distribution.

Jean-loup Gailly
jloup@gzip.org

Mark Adler
madler@alumni.caltech.edu

*/

libpng

This copy of the libpng notices is provided for your convenience. In case of any discrepancy between this copy and the notices in the file png.h that is included in the libpng distribution, the latter shall prevail.

COPYRIGHT NOTICE, DISCLAIMER, and LICENSE:

If you modify libpng you may insert additional notices immediately following this sentence.

libpng versions 1.2.6, August 15, 2004, through 1.2.29, May 8, 2008, are Copyright (c) 2004, 2006-2008 Glenn Randers-Pehrson, and are distributed according to the same disclaimer and license as libpng-1.2.5 with the following individual added to the list of Contributing Authors

Cosmin Truta

libpng versions 1.0.7, July 1, 2000, through 1.2.5 - October 3, 2002, are Copyright (c) 2000-2002 Glenn Randers-Pehrson, and are distributed according to the same disclaimer and license as libpng-1.0.6 with the following individuals added to the list of Contributing Authors

Simon-Pierre Cadieux
Eric S. Raymond
Gilles Vollant

and with the following additions to the disclaimer:

There is no warranty against interference with your enjoyment of the library or against infringement. There is no warranty that our efforts or the library will fulfill any of your particular purposes or needs. This library is provided with all faults, and the entire risk of satisfactory quality, performance, accuracy, and effort is with the user.

libpng versions 0.97, January 1998, through 1.0.6, March 20, 2000, are Copyright (c) 1998, 1999 Glenn Randers-Pehrson, and are distributed according to the same disclaimer and license as libpng-0.96, with the following individuals added to the list of Contributing Authors:

Tom Lane
Glenn Randers-Pehrson
Willem van Schaik

libpng versions 0.89, June 1996, through 0.96, May 1997, are Copyright (c) 1996, 1997 Andreas Dilger

Distributed according to the same disclaimer and license as libpng-0.88, with the following individuals added to the list of Contributing Authors:

John Bowler
Kevin Bracey
Sam Bushell
Magnus Holmgren
Greg Roelofs
Tom Tanner

libpng versions 0.5, May 1995, through 0.88, January 1996, are Copyright (c) 1995, 1996 Guy Eric Schalnat, Group 42, Inc.

For the purposes of this copyright and license, "Contributing Authors" is defined as the following set of individuals:

Andreas Dilger
Dave Martindale
Guy Eric Schalnat
Paul Schmidt
Tim Wegner

The PNG Reference Library is supplied "AS IS". The Contributing Authors and Group 42, Inc. disclaim all warranties, expressed or implied, including, without limitation, the warranties of merchantability and of fitness for any purpose. The Contributing Authors and Group 42, Inc. assume no liability for direct, indirect, incidental, special, exemplary, or consequential damages, which may result from the use of the PNG Reference Library, even if advised of the possibility of such damage.

Permission is hereby granted to use, copy, modify, and distribute this source code, or portions hereof, for any purpose, without fee, subject to the following restrictions:

1. The origin of this source code must not be misrepresented.
2. Altered versions must be plainly marked as such and must not be misrepresented as being the original source.
3. This Copyright notice may not be removed or altered from any source or altered source distribution.

The Contributing Authors and Group 42, Inc. specifically permit, without fee, and encourage the use of this source code as a component to supporting the PNG file format in commercial products. If you use this source code in a product, acknowledgment is not required but would be appreciated.

A "png_get_copyright" function is available, for convenient use in "about" boxes and the like:

```
printf("%s",png_get_copyright(NULL));
```

Also, the PNG logo (in PNG format, of course) is supplied in the files "pngbar.png" and "pngbar.jpg" (88x31) and "pngnow.png" (98x31).

Libpng is OSI Certified Open Source Software. OSI Certified Open Source is a certification mark of the Open Source Initiative.

Glenn Randers-Pehrson
glennrp at users.sourceforge.net
May 8, 2008

Dimensions

Unit: in. (mm)

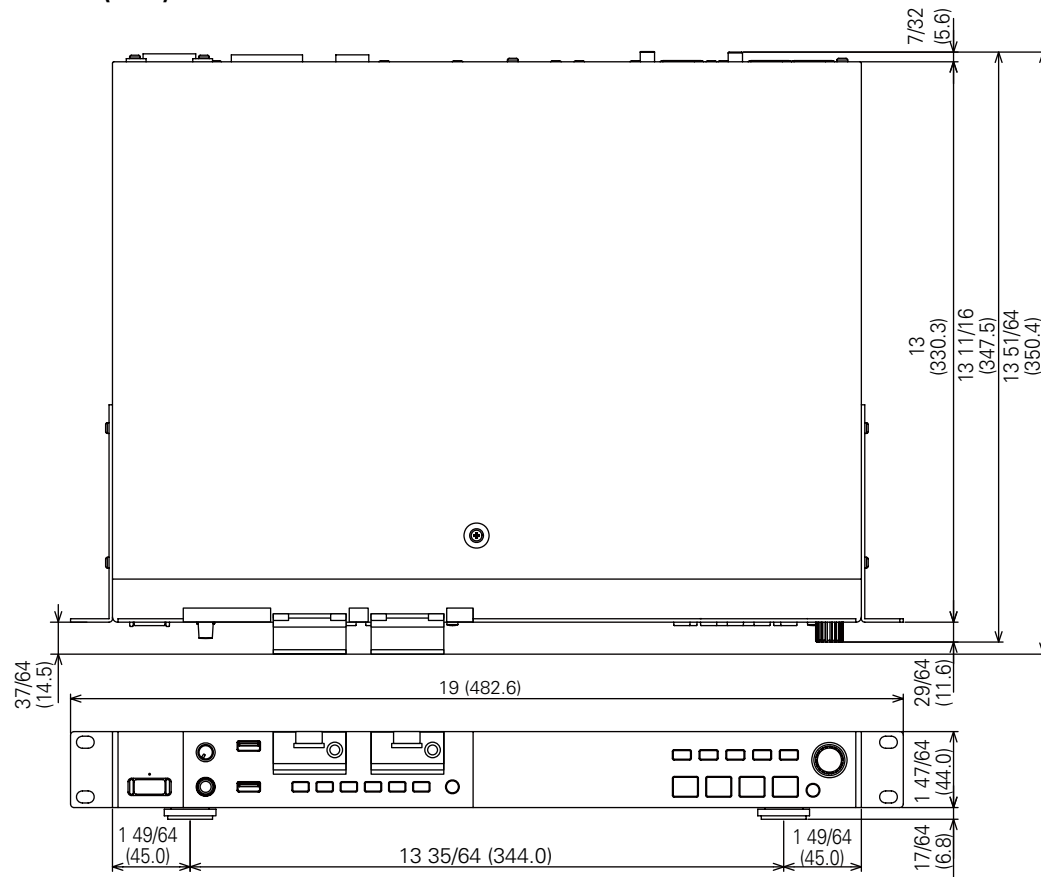

Weight: 7 lbs 14.99 oz (3.6 kg)

D&M Holdings Inc.