

DCi Series – Analog Input Models

Operation Manual



DCi 8|600

DCi 8|300

DCi 4|1250

DCi 4|600

DCi 4|300

DCi 2|1250

DCi 2|600

DCi 2|300

Obtaining Other Language Versions: To obtain information in another language about the use of this product, please contact your local Crown Distributor. If you need assistance locating your local distributor, please contact Crown at 574-294-8000.





This manual does not include all of the details of design, production, or variations of the equipment. Nor does it cover every possible situation which may arise during installation, operation or maintenance.

The information provided in this manual was deemed accurate as of the publication date. However, updates to this information may have occurred. To obtain the latest version of this manual, please visit the Crown website at www.crownaudio.com.

Trademark Notice: Com-Tech, BCA, Crown, Crown Audio, Amcron and Multi-Mode are registered trademarks of Crown International. DriveCore, DriveCore Install, IQwic, PIP and PIP2 are trademarks of Crown International. Other trademarks are the property of their respective owners.

Some models may be exported under the name Amcron®

Important Safety Instructions

1. Read these instructions.
2. Keep these instructions.
3. Heed all warnings.
4. Follow all instructions.
5. Do not use this apparatus near water.
6. Clean only with a dry cloth.
7. Do not block any ventilation openings. Install in accordance with the manufacturer's instructions.
8. Do not install near any heat sources such as radiators, heat registers, stoves, or other apparatus that produce heat.
9. Do not defeat the safety purpose of the Grounding-type plug. A polarized plug has two blades with one wider than the other and should not be used with this product. A grounding-type plug has two blades and a third grounding prong and is the proper plug for this product. The wide blade or the third prong is provided for your safety. If the provided plug does not fit into your outlet, consult an electrician for replacement of the obsolete outlet.
10. Protect the power cord from being walked on or pinched, particularly at plugs, convenience receptacles, and the point where they exit from the apparatus.
11. Only use attachments/accessories specified by the manufacturer.
12.  Unplug this apparatus during lightning storms or when unused for long periods of time.
13. Refer all servicing to qualified service personnel. Servicing is required when the apparatus has been damaged in any way, such as power-supply cord or plug is damaged, liquid has been spilled or objects have fallen into the apparatus, the apparatus has been exposed to rain or moisture, does not operate normally, or has been dropped.
14. Use the mains plug to disconnect the apparatus from the mains.
15. **WARNING: TO REDUCE THE RISK OF FIRE OR ELECTRIC SHOCK, DO NOT EXPOSE THIS APPARATUS TO RAIN OR MOISTURE.**
16.  **DO NOT EXPOSE THIS EQUIPMENT TO DRIPPING OR SPLASHING AND ENSURE THAT NO OBJECTS FILLED WITH LIQUIDS, SUCH AS VASES, ARE PLACED ON THE EQUIPMENT.**
17. **THE MAINS PLUG OF THE POWER SUPPLY CORD SHALL REMAIN READILY OPERABLE.**
18.  **TO PREVENT ELECTRIC SHOCK DO NOT REMOVE TOP COVER. NO USER SERVICEABLE PARTS INSIDE. REFER SERVICING TO QUALIFIED SERVICE PERSONNEL.**
19.  **TO COMPLETELY DISCONNECT THIS EQUIPMENT FROM THE AC MAINS, DISCONNECT THE POWER SUPPLY CORD PLUG FROM THE AC RECEPTACLE. THE MAINS PLUG OF THE POWER SUPPLY CORD SHALL REMAIN READILY OPERABLE.**

WATCH FOR THESE SYMBOLS:



The lightning bolt triangle is used to alert the user to the risk of electric shock.



The exclamation point triangle is used to alert the user to important operating or maintenance instructions.



IMPORTANT



DriveCore Install Series amplifiers require Class 2 output wiring.

MAGNETIC FIELD

CAUTION! Do not locate sensitive high-gain equipment such as preamplifiers or tape decks directly above or below the unit. Because this amplifier has a high power density, it has a strong magnetic field which can induce hum into unshielded devices that are located nearby. The field is strongest just above and below the unit.

If an equipment rack is used, we recommend locating the amplifier(s) in the bottom of the rack and the preamplifier or other sensitive equipment at the top.

FCC COMPLIANCE NOTICE

This device complies with part 15 of the FCC rules. Operation is subject to the following two conditions: (1) This device may not cause harmful interference, and (2) this device must accept any interference received, including interference that may cause undesired operation.

CAUTION: Changes or modifications not expressly approved by the party responsible for compliance could void the user's authority to operate the equipment.

NOTE: This equipment has been tested and found to comply with the limits for a Class B digital device, pursuant to part 15 of the FCC Rules. These limits are designed to provide reasonable protection against harmful interference in a residential installation. This equipment generates, uses, and can radiate radio frequency energy and, if not installed and used in accordance with the instruction manual, may cause harmful interference to radio communications. However, there is no guarantee that interference will not occur in a particular installation. If this equipment does cause harmful interference to radio or television reception, which can be determined by turning the equipment off and on, the user is encouraged to try to correct the interference by one or more of the following measures:

- Reorient or relocate the receiving antenna.
- Increase the separation between the equipment and receiver.
- Connect the equipment into an outlet on a circuit different from that to which the receiver is connected.
- Consult the dealer or an experienced radio/TV technician for help.

DECLARATION OF CONFORMITY

Issued By: Harman International.
1718 W. Mishawaka Rd.
Elkhart, IN 46517 U.S.A.

European Representative's Name and Address:

David J. Budge
10 Harvest Close
Yateley, GU46 6YS
United Kingdom

Equipment Type: Commercial Audio Power Amplifiers

Family Name: DCi

Model Names: DCi 2|300, DCi 2|600, DCi 2|1250, DCi 4|300, DCi 4|600, DCi 4|1250, DCi 8|300, DCi 8|600

EMC Standards:

EN 55103-1:2009 EMC Compatibility – Product Family Standard for Audio, Video, Audio-Visual and Entertainment Lighting Control Apparatus for Professional Use, Part 1: Emissions

EN 55103-1:2009 Magnetic Field Emissions-Annex A @ 10 cm and 20 cm

EN 61000-3-2:2006 Limits for Harmonic Current Emissions (equipment input current less than or equal to 16A

EN 61000-3-3:2008 Limitation of Voltage Fluctuations and Flicker in Low-Voltage Supply systems Rated Current less than or equal to 16A

EN 55022:2010 Limits and Methods of Measurement of Radio Disturbance Characteristics of ITE: Radiated & Conducted, Class B Limits

EN 55103-2:2009 EMC Compatibility – Product Family Standard for Audio, Video, Audio-Visual and Entertainment Lighting Control Apparatus for Professional Use, Part 2: Immunity

EN 61000-4-2:2008 Ed 2.0 EMC Compatibility – Product Family Standard for Audio, Video, Audio-Visual and Entertainment Lighting Control Apparatus for Professional Use, Part 2: Immunity

EN 61000-4-3:2010 Ed 3.2 Radiated, Radio-Frequency, Electromagnetic Immunity (Environment E2, criteria A)

EN 61000-4-4:2007 Radiated, Radio-Frequency, EMC Immunity (Environment E2, Criteria A)

EN 61000-4-5:2006 Surge Immunity (Criteria B)

EN 61000-4-6:2006 Immunity to Conducted Disturbances Induced by Radio-Frequency Fields (Criteria A)

EN 61000-4-11:2004 Voltage Dips, Short Interruptions and Voltage Variation

Safety Standard:

IEC 60065:2001 Ed 7 +A1:2005 +A2:2010 Safety Requirements – Audio, Video, and Similar Electronic Apparatus

CAN/CSA 60065-03 +A1 +A2 Safety Requirements – Audio, Video, and Similar Electronic Apparatus

UL Std No 60065-03 (2012) Safety Requirements – Audio, Video, and Similar Electronic Apparatus

I certify that the product identified above conforms to the requirements of the EMC Council Directive 2004/108/EC and the Low Voltage Directive 2006/95/EC.

Signed



Jeff Denman
Sr. Director of Manufacturing

Date of Issue: October 1, 2013

Due to line current harmonics, we recommend that you contact your supply authority before connection.

Table of Contents

Important Safety Instructions	2
Declaration of Conformity.....	3
Table of Contents.....	4
Welcome	5
Installation	6
Set-up and System Configuration	7
Front & Back Panel Features	13
Global & Per Channel Settings	14
Protection System	15
Troubleshooting	16
DCi Specifications	18
AC Power Draw and Thermal Dissipation.....	21
Service.....	29
Warranty	31
Crown Audio Factory Service Information	32
Product Registration	33

Welcome

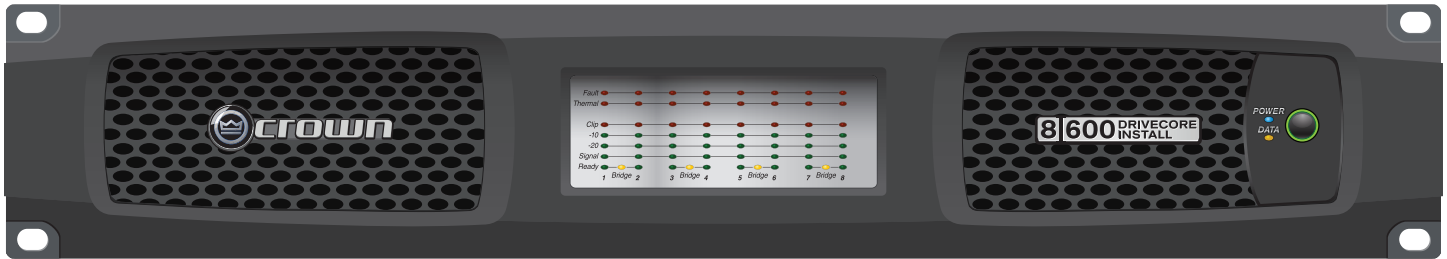

Thank you for purchasing a new Crown DriveCore install™ Series installation amplifier, one in a complete line of high-performance amplifiers based on exclusive DriveCore™ technology. DCi Series amplifiers are designed, engineered and manufactured to the industry's highest quality standards, and provide system integrators with the advanced features and flexibility required for challenging 21st century installed sound applications. Versatile, compact and highly energy-efficient, DCi Series amplifiers continue the unbroken Crown tradition of leadership in professional and commercial power amplifier technology.

Features

- Exclusive DriveCore Technology – The patented DriveCore integrated circuit combines hundreds of discrete circuits into one chip for better performance, lower power consumption and improved reliability.
- Power Saving Modes – Power consumption in sleep mode is less than 1W.
- Auto Standby – Amplifier goes into Sleep mode after 30 minutes of no input signal.
- Remote Power Off – Sleep mode activated via AUX port.
- 70 V / 100 V Direct Drive – Each channel individually selectable for low-Z or high-Z operation.
- 100 V Direct Drive Capability – Higher voltage allows more speakers per output and reduced wiring costs.
- TLC Protection – Protects amplifier from excessive heat and maintains operation by intelligently applying gain reduction when necessary.
- Advanced Protection Circuits – Amplifier and loads are protected against shorted outputs, DC, mismatched loads, overheating, over- or under-voltage, and high frequency overload.
- Three Year, No-Fault Transferable Warranty – Your investment is fully protected.
- Complies with Green Edge by Harman – Environmentally friendly practices in design, manufacturing, and packaging complement energy-efficient operation.
- PFC Power Supply – the next generation power supply design guarantees minimum rated power delivered for drastically lower current draw.

How to Use This Manual

This manual provides you with the necessary basic information to safely and correctly set up and operate your amplifier. However, it does not cover every aspect of installation, setup, or operation that might occur under every condition. For additional information, please consult Crown's Amplifier Application Guide (available online at www.crownaudio.com), Crown Technical Support, your system installer, or the retailer where this amplifier was purchased.

Installation

Unpacking

Unpack your amplifier and inspect for any damage that may have occurred during transit. If damage is found, notify the shipping company immediately. Only you can initiate a claim for shipping damage, though Crown will be happy to help as needed. If the product arrived showing signs of damage, save the shipping carton for the shipper's inspection.

We also recommend that you save all packing materials for use if you ever need to transport the unit. Never ship the unit without the factory carton and packing materials.

Additional Materials

FOR INSTALLATION, YOU WILL NEED (not supplied):

- Input wiring cables
- Output wiring cables
- Flathead screwdriver
- Phillips screwdriver
- Rack for mounting amplifier (or a stable surface for stacking)



WARNING: Before you start to set up your amplifier, read and observe the Important Safety Instructions found at the beginning of this manual.

Install the Amplifier



CAUTION: Before you begin, make sure your amplifier is disconnected from the power source and that all level controls (see Page 14) are set to INF.

All DCi Series amplifiers are 3.5 in. (8.9 cm) high and 19 in. (48.3 cm) wide. All are 14.25 in. (36.2 cm) deep except the DCi8|600 and 4|1250 which is 17 in. (43.2 cm) deep. (See Figure 1)

Mount the unit in a standard 19-inch (48.3 cm) equipment rack (EIA RS-310B). You can also place a single amp on a solid, stable surface or stack multiple amps.

NOTE: Amplifiers should be supported at both the front and rear of the rack.

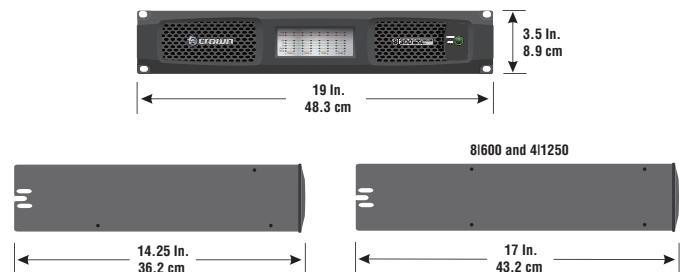

Figure 1

Ensure Proper Cooling

When using an equipment rack, mount units directly on top of each other. Close any open spaces in the rack with blank panels. (Open spaces will reduce cooling efficiency.) DO NOT block front or rear air vents.

The rack should be a minimum of two inches (5.1 cm) away from the amplifier, and the back of the rack should be a minimum of four inches (10.2 cm) from the amplifier back panel.

Air flow is front to back as illustrated in Figure 2.

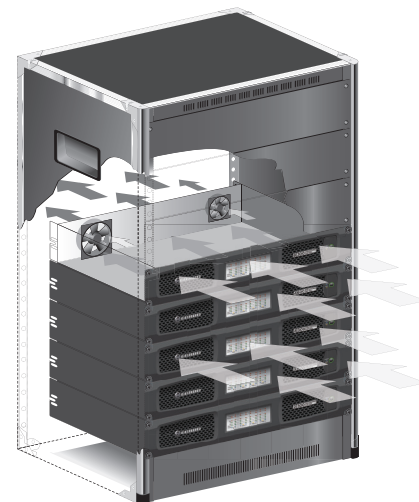

Figure 2

Set-up and System Configuration

Wire Input Connectors

Crown recommends using pre-built or professionally wired balanced line (two-conductor plus shield). Balanced wiring provides better rejection of unwanted noise and hum; however, unbalanced line may also be used. For more information, refer to the Crown Amplifier Application Guide, available online at www.crownaudio.com.

Use 6-pin plug-in cable ends at the amp input connectors. A male connector is supplied for each input of your model of amplifier. Additional connectors are available from Crown (P/N 5024623).

Figure 3 shows connector pin assignments for balanced wiring and Figure 4 shows connector pin assignments for unbalanced wiring. Note that for bridged operation, only the connectors for odd-numbered channels (1,3,5,7) for each bridged pair need be wired. See Page 9 and 11.

Figure 3

BALANCED LINE

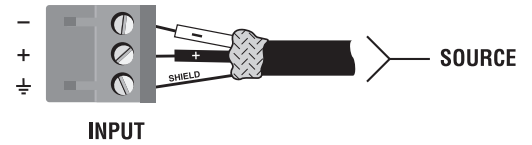

UNBALANCED LINE

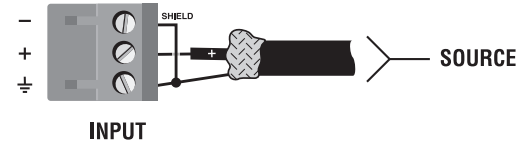

Figure 4

Wire Output Connectors

Crown has designed an output cover that does not need to be removed to connect the output wiring.

Crown recommends using the included spade connectors and two- or four-conductor, heavy gauge speaker wire. You may use terminal forks up to 10 AWG or bare wire for your output connectors (see Figure 5). For best results, Crown recommends Panduit part #PV10-6LF-L or equivalent terminal fork. For bare wire, it is highly recommended that output wiring is tinned. To reduce strain on input and output wiring, Crown recommends the use of horizontal lacer bars. For best results, Crown recommends Middle Atlantic part# LBP-4R90 or equivalent horizontal lacer bar.

To prevent the possibility of short-circuits, wrap or otherwise insulate exposed loudspeaker cable connectors.

For low-impedance loads, select the appropriate size of wire based on the distance from amplifier to speaker.

Distance	Wire Size
Up to 25 ft. (7.6m)	16 AWG
26-40 ft. (7.9-12.2m)	14 AWG
41-60 ft. (12.5-18.3m)	12 AWG
> 60 ft (18.3m)	10 AWG

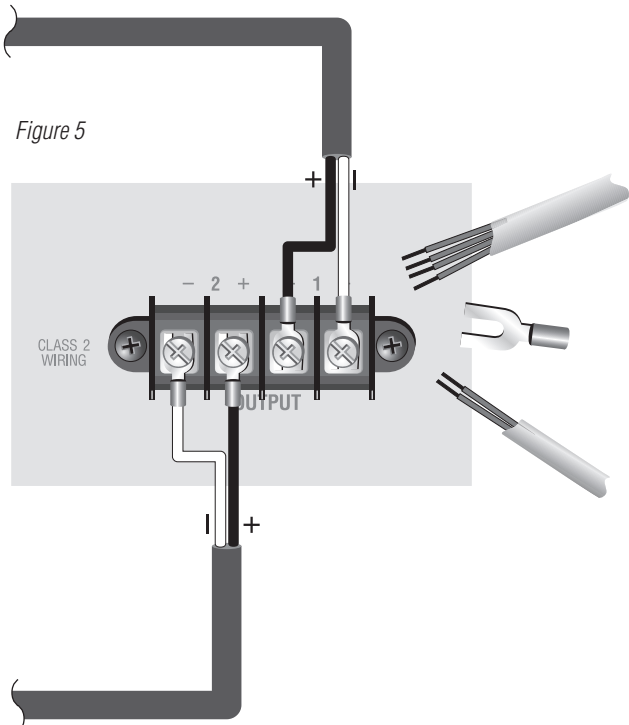

Figure 5



CAUTION: Never use shielded cable for output wiring.



CAUTION: Never connect the speaker return to the chassis of the amplifier, or damage to the amplifier may result.



NOTE: Custom wiring should only be performed by qualified personnel. Class 2 output wiring is required.

Set-up and System Configuration

Connect Loudspeakers and Configure for Loudspeaker Load

Determine load impedances and power requirements

Before making any connections, carefully check and review the total impedance for loudspeaker systems to be connected to each amplifier output. If multiple loudspeakers are connected to one output (in series, parallel or series-parallel) for Lo-Z operation, be certain the total system impedance is within allowed specification for the output. When multiple loudspeakers are connected to one output for Hi-Z operation, be certain total tapped power is below the rated power output for the channel. For additional information, please consult Crown's Amplifier Application Guide (available online at www.crownaudio.com).

Note: Illustrations and some text references are for channel pair 1 - 2 only. Connections and settings are identical for channels 3 – 4 on four-channel models and for channels 5 – 6 and 7 – 8 on eight-channel models. Each channel pair may be configured independently on multichannel models.

Dual Mode Low-Z (8, 4 or 2 Ohm)

Typical input and output wiring, along with Attenuator and Mode DIP Switch settings are shown in Figure 6. Make sure DIP Switches are in the default OFF (down) position.

INPUTS: Connect the input with wiring in place for each channel. If the same signal is to drive both outputs of a channel pair ("mono"), the signal must be split externally and applied to both inputs.

OUTPUTS: Maintain proper polarity (+/–) on output connectors. Connect the Channel 1 speaker's positive (+) lead to amplifier Channel 1 positive terminal; repeat for negative (–). Repeat Channel 2 wiring as for Channel 1, and for any subsequent channel pairs on multichannel models. Refer to Page 7 for output connector terminal assignments.

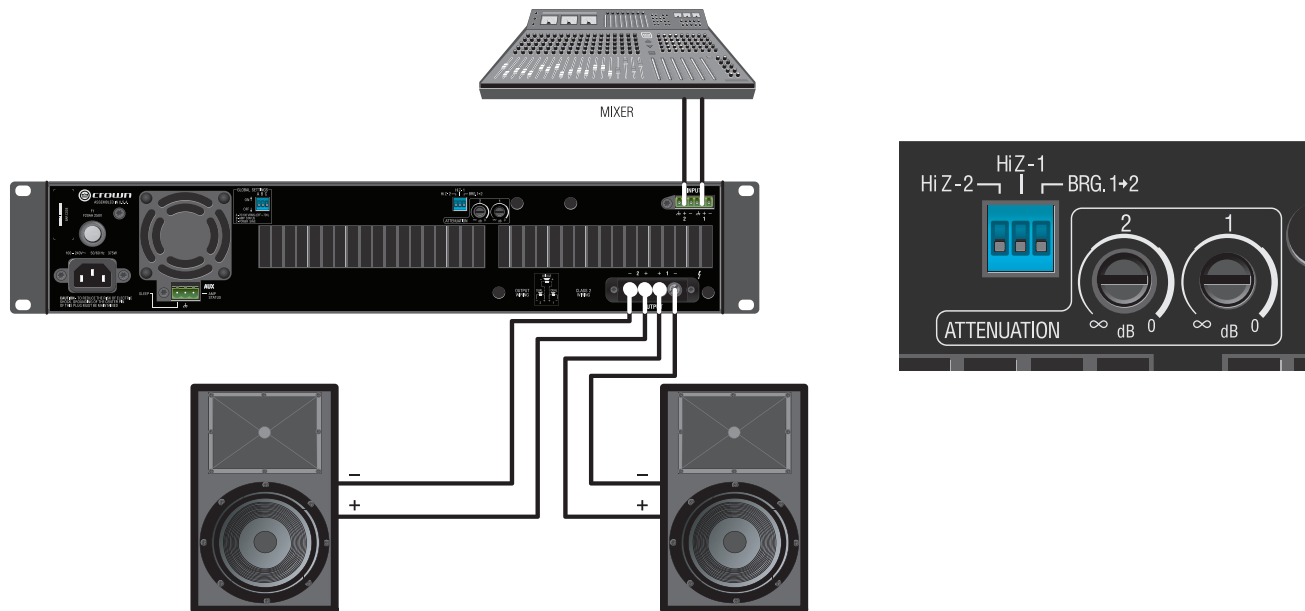

Figure 6 System Wiring Dual Mode

Always route the input and output wires in separate bundles.

Set-up and System Configuration

Bridge Mode (16, 8, or 4 Ohm)

Typical input and output wiring, along with Attenuator and Mode DIP Switch settings are shown in Figure 7. Make sure the “Hi-Z” selector switches are in the OFF (down) position and the Bridge (BRG) switch is in the ON (up) position. NOTE: Only the Hi-Z selector switches assigned to odd-numbered channels (1,3,5,7) are active in Bridge mode; switches assigned to even-numbered channels (2,4,6,8) are disabled.

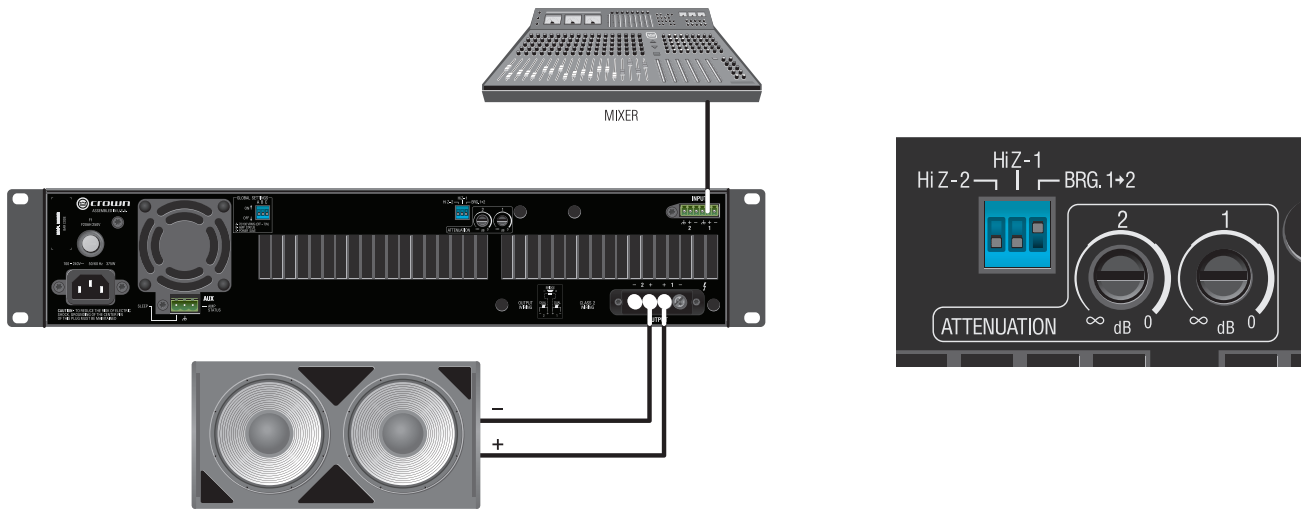

Figure 7 System Wiring Bridge Mode

Always route the input and output wires in separate bundles.

Set-up and System Configuration

Dual Mode Hi-Z (70V/100V)

Typical input and output wiring, along with Attenuator and Mode DIP Switch settings are shown in Figure 8. Make sure the “Hi-Z” selector switches are in the ON (up) position and the Bridge (BRG) switch is in the OFF (down) position. A 35Hz high pass filter is selected automatically when the amplifier channel is in Hi-Z or Bridged Hi-Z mode. The filter can be changed to 70Hz, please contact your local Crown service center for detailed instruction for this modification. Remember, DCi amplifiers allow each channels Hi-Z or Low-Z mode of operation to be selected independently, while 70V/100V selection is global.

NOTE: For 70V systems, be sure that Global DIP Switch A is in the OFF position. For 100V systems, be sure that Global DIP Switch A is in the ON position.

INPUTS: Connect the input with wiring in place for each channel. If the same signal is to drive both outputs of a channel pair (“mono”), the signal must be split externally and applied to both inputs.

OUTPUTS: Connect the outputs as shown to a Hi-Z (70V / 100V) loudspeaker system.

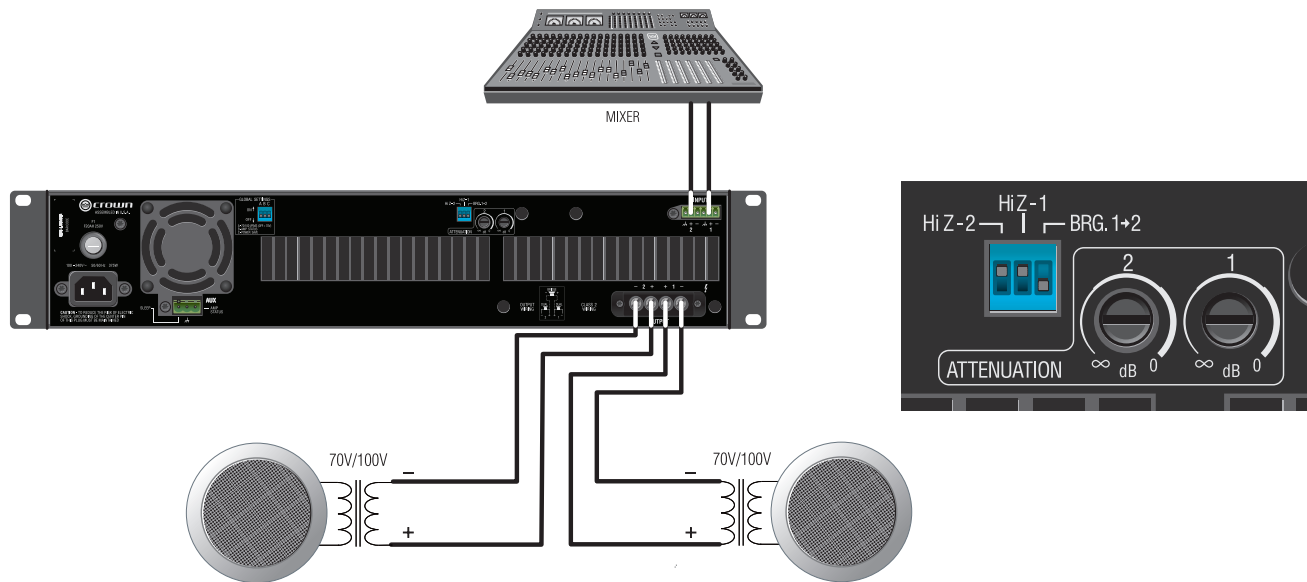

Figure 8 System Wiring for 70V/100V Operation

Always route the input and output wires in separate bundles.

Set-up and System Configuration

Bridge Mode Hi-Z (140V/200V)

Typical input and output wiring, along with Attenuator and Mode DIP Switch settings are shown in Figure 9. Make sure the “Hi-Z” selector switch for the connected input channel is in the ON (up) position and the Bridge (BRG) switch for the channel pair also is in the ON (up) position. A 35Hz high pass filter is selected automatically when the amplifier channel is in Hi-Z or Bridged Hi-Z mode. The filter can be changed to 70Hz, please contact your local Crown service center for detailed instruction for this modification. NOTE: Only the Hi-Z selector switches assigned to odd-numbered channels (1,3,5,7) are active in Bridge mode; switches assigned to even-numbered channels (2,4,6,8) are disabled.

INPUTS: Connect the input to the odd-numbered channels (1,3,5,7) only. Even-numbered inputs are disabled when the Bridge DIP Switch is ON.

OUTPUTS: Connect the speaker across the positive terminals of each channel pair. Do not use the negative terminals of the channel pair when the pair is being operated in Bridge-Mono mode.

NOTE: For global selection of 70V (140V bridged) or 100V (200V bridged) operation, refer to Page 14.

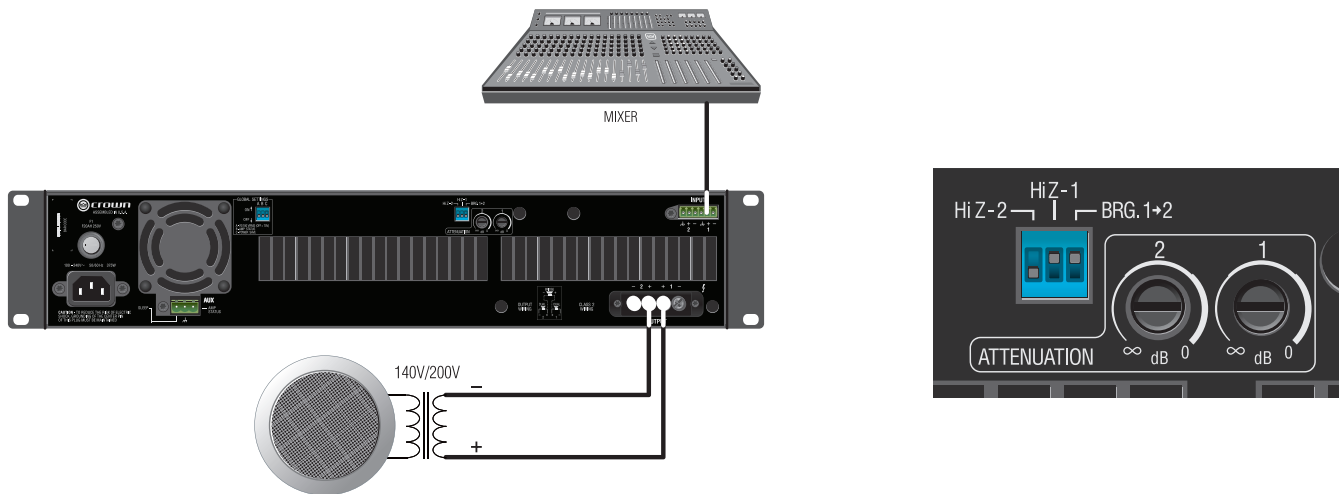

Figure 9 System Wiring for 70V/100V Operation

Always route the input and output wires in separate bundles.

Set-up and System Configuration

Connect to AC Mains

Connect your amplifier to the AC mains power source (power outlet) using the supplied AC power cord set. First, connect the IEC end of the cord set to the IEC connector on the amplifier; then, plug the other end of the cord set to the AC mains.



WARNING: The third prong of this connector (ground) is an important safety feature. Do not attempt to disable this ground connection by using an adapter or other methods.

Make certain the AC mains voltage and current ratings are sufficient to deliver full power to all amplifiers. If the AC line voltage varies out of an acceptable range, the amplifier's power supply turns off and the blue Power LED flashes. The amplifier will turn back on when the AC line voltage returns to safe operating levels.

DriveCore Install Amplifiers utilize a universal power supply. The AC voltage requirements are 100VAC - 240VAC, 50/60Hz (+/-10%). If the voltage exceeds these requirements, then the Power LED will flash and the amplifier will stop passing audio until the voltage is within the requirements.

Startup Procedure

When first turning on your amplifier:

1. Turn down the level of your audio source.
2. Turn down the level controls of the amplifier to INF Page 14.
3. Turn on the "Power" switch. The Power indicator should light.
4. Turn up the level of your audio source to an optimum level. Ensure that at no point in the signal chain is the signal being clipped in any way.
5. Turn up the level controls on the amplifier to the desired loudness or power level.

IMPORTANT: Before making any wiring or installation changes, turn off the amplifier and disconnect the power cord.

For help with determining your system's optimum gain structure (signal levels) please refer to the Crown Amplifier Application Guide, available online at www.crownaudio.com.

Precautions

Your amplifier is protected from internal and external faults, but you should still take the following precautions for optimum performance and safety:

1. Configure the amplifier for proper operation, including input and output wiring hookup. Improper wiring can result in serious operating difficulties. For information on wiring and configuration, please consult Page 7 of this manual. For advanced setup techniques, consult Crown's Amplifier Application Guide available online at www.crownaudio.com.
2. Use care when making connections, selecting signal sources and controlling the output level. The load you save may be your own!
3. Do not short the ground lead of an output cable to the input signal ground. This may form a ground loop and cause oscillations.
-  **4. Never connect the output to a power supply, battery or power main. Electrical shock may result.**
5. Tampering with the circuitry or making unauthorized circuit changes may be hazardous and invalidate all agency listings.
6. Do not operate the amplifier with the RED Clip LEDs constantly flashing.
7. Do not overdrive the mixer, which will cause clipped signal to be sent to the amplifier. Such signals will be reproduced with extreme accuracy, and loudspeaker damage may result.
8. Do not operate the amplifier with less than the rated load impedance. Due to the amplifier's output protection, such a configuration may result in premature clipping and speaker damage.

Remember: Crown is not liable for damage that results from overdriving other system components.

Front Panel Features

Indicators:

Fault Indicator (red): Flashes when the amplifier output channel has stopped operating. (See Page 16 Troubleshooting.)

Thermal Indicator (red): Illuminates when the channel reaches 80 degrees Celsius, indicating the onset of protection compression.

Clip Indicator (red): Illuminates when any of the following conditions are present: Onset of audible clipping, clipped signal detected at input, clipped signal detected at output, engagement of TLC protection circuit.

Level and Signal Indicators (green): Three LEDs indicate signal presence and level as follows: -10 = 10 dB below rated output -20 = 20 dB below rated output Signal = -40dBu input level

Ready Indicator (green): When this indicator is activated, the amplifier is ready to pass audio.

Power Indicator (blue)

Illuminates when the amplifier is ON and acceptable AC line voltage is present.

Blinks when AC line voltage is outside $\pm 10\%$ range.

Flashes for 4 seconds if Power button pressed when amplifier is in sleep mode. (page 16)

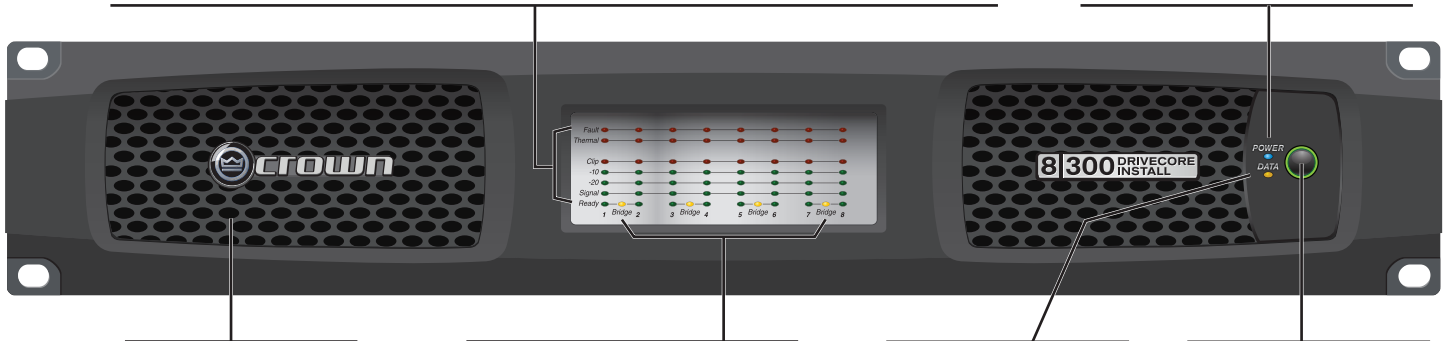

Cooling Vent Grille
Provides cooling air flow. Do not block or cover these vents.

Bridge Mode Indicator (yellow)
Illuminates when Bridge Mode is activated for the channel pair, only odd number channel will be active

Data Indicator (yellow)
Illuminates when data present on the network. (Not used in analog input versions.)

Power Button
Power Ring Indicator (Green) - Illuminates when the amplifier is plugged into a wall outlet with acceptable power.

Note: Eight channel model shown. Indications per channel pair are identical for 2 and 4 channel models.

Back Panel Features

Power Fuse

F20AH 250V, replace with same type fuse. Littelfuse 314 Series. DCi81600 & 411250 incorporate the use of a resettable breaker instead of fuse.

Global Setting DIP Switches

Settings for 70/100 VRMS (Hi-Z operation) operation mode, AMP STATUS and POWER SAVE. These DIP switches affect all output channels. (Refer to Page 14)

Channel Pair DIP Switches

One block of three DIP Switches for each channel pair. Allows selection of Lo-Z or Hi-Z operation per channel and bridging of designated channel pairs. (Refer to Page 14)

Input Attenuators

One 21-position detented potentiometer per channel. Logarithmic audio taper. Attenuation range -95 dB to 0 dB

Input Connectors

One 6-pin plug-in connector per input. High impedance balanced. (Refer to Page 7)

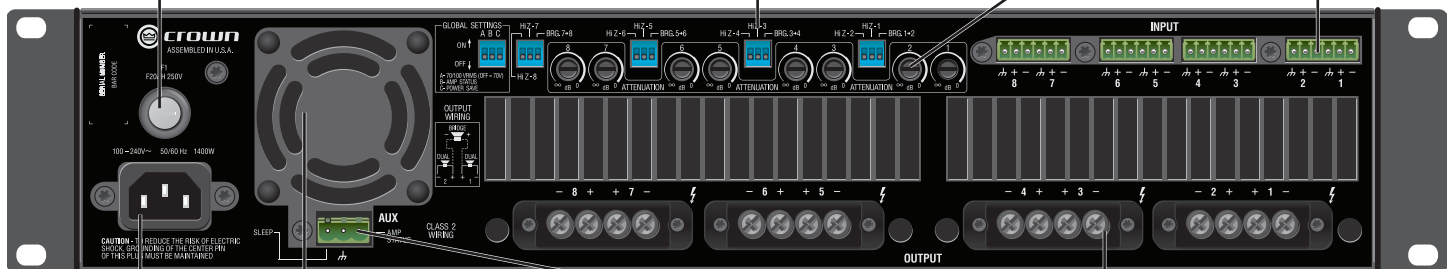

AC Power Inlet:

Standard IEC type 320 inlet for detachable connector 100 - 240 V~. The DCi81600 and 411250 utilize a 20A IEC connector. All other models use a 15A connector.

Cooling Fan Outlet

Outlets for cooling air flow. Do not block or cover these outlets.

Auxiliary Connector

3-pin plug-in type connector, Enables SLEEP mode and monitoring of AMP STATUS unless the amplifier is in any of these conditions: OFF, SLEEP, or FAULT. (see Page 14)

Output Connectors

One four-pole touch-proof terminal strip per channel pair. Accepts up to 10 AWG wire or terminal forks.

Note: This image reflects the DCi 81300 back panel

Global Settings

70/100 VRMS (switch A)

This switch selects either 70 or 100 VRMS operation for all outputs currently selected for Hi-Z mode. (See the section below, Hi-Z.) Default position is 70 V (OFF). In 70 V and 100 V mode, a voltage limiter circuit is enabled. NOTE: When bridged Hi-Z mode is implemented, selected voltages are doubled to 140V or 200V.

Amplifier Status (switch B)

The Amplifier Status works with life safety or supervisory monitoring and control systems where notification of an amplifier fault is necessary. The Amplifier Status produces a signal (“heartbeat”) when the amplifier is operating within standard working parameters. If the amplifier enters a fault or thermal condition, the Amplifier Status signal will terminate. This feature is always on and available when the amplifier is ready to deliver audio in selected mode through the AMP STATUS line on the AUX port.

The Amplifier Status signal is selectable:

- ON – the microcontroller will send a 2 Hz pulse to the “AMP STATUS” AUX port line.
- OFF – the microcontroller will send a logic high level to the “AMP STATUS” AUX port line.

The voltage output of the Aux Port is 5VDC at 0.9 milliamps. This TTL or similar signal can then be connected to an interface to indicate the amplifier status to a supervisory control system.

Amp status can be used in a variety of life safety applications

Power Save (switch C)

The Power Save switch enables the Auto-Standby function. In OFF position, the Auto Standby feature is disabled; amplifier power on/off is controlled by the front panel switch or the AUX port ground closure.

In the ON position, Auto Standby is enabled. If the amplifier input does not see signal for 30 minutes, the amplifier will power down to consume less than 1W of power. When -40dBu of input signal is applied, then the amplifier will power up for activation. The power up sequence will take approximately 4 - 5 seconds.

Per Channel Settings

Note: The following text and illustrations refer to one channel pair, channels 1 and 2. Settings and functions are identical for other channels pairs (3/4, 5/6, 7/8) in multichannel models.

Hi-Z

Each channel of the channel pair is individually selectable for Lo-Z or Hi-Z operation. When Hi-Z operation is selected (ON, up) a 35Hz high pass filter is selected automatically. The filter can be changed to 70Hz. Contact your local Crown service center for detailed instruction for this change. When a channel pair is configured for bridged Hi-Z mode, only switches assigned to the odd-numbered channels (1,3,5,7) are active; switches for the even-numbered channels (2,4,6,8) are disabled.

Channel Attenuators

Each channel is supplied with a logarithmic 21-position detented input attenuator. Use a flat-blade screwdriver to set input level. Attenuation is from -95 dB (full counter-clockwise) to 0 dB (full clockwise).

Position	0	1	2	3	4	5	6	7	8	9	10
Typical Attenuation	0	0.1	3	6	8	9.5	11	12.5	14	15.5	16.5

Position	11	12	13	14	15	16	17	18	19	20
Typical Attenuation	17.5	19	20.5	22.5	24.5	27.5	32	42	90	95

Protection System

Thermal Indicator

If the amplifier becomes too hot for safe operation, the channel that is generating too much heat will be shut down until the temperature drops below the thermal limit. The front-panel thermal indicator will illuminate at 80 degrees Celsius, indicating the onset of compression affecting the audio signal. The amplifier will continue to run in this state until either the temperature is reduced to a safe operating range, or if the temperature continues to rise, the channel will shut off to protect itself above 98 degrees Celsius.

Fault

The amplifier will enter a Fault state if the amplifier senses an unsafe condition. This protection is for both internal and external faults. It is critical to check all wiring to and from the amplifier to ensure the fault is not caused by external conditions. If wiring is verified as correct and the fault condition persists, see Page 29 for servicing information.

Auto Insertion High-Pass Filters

A 35 Hz high-pass filter is inserted automatically when a channel is selected for Hi-Z operation. The filter can be changed to a 70Hz high pass filter. Please contact Crown Service Department for further information.

AC Under/Over Voltage Protection

If the AC line voltage drops below 10% or rises above 10% of the nominal operating voltage of the amplifier, the amplifier's power supply turns off and the blue Power LED flashes. The amplifier will turn back on when the AC line voltage returns to safe operating levels.

Fuse

A fuse (F1) located near the IEC power inlet protects the amplifier from excessive AC current draw. The fuse is field replaceable. Replace with same type fuse; Littelfuse 314 Series F20AH 250V. The 8|600 and 4|1250 utilize a resettable breaker instead of a fuse. Please contact Crown Service department for more information.

Fan-cooled Chassis

DCi Series amplifiers are cooled by quiet, variable speed fans. The fans will pull air from the front of the amplifier to the rear of the amplifier.

Universal Switching Power Supply

The DCi Series incorporates a new switching power supply designed for extremely high efficiency and high output power. The supply includes Power Factor Correction (PFC), a Series Resonant Converter (SRC) and accepts AC supply voltages from 100 V~ to 240 V~. Microprocessor controlled diagnostic and control capabilities both optimize performance, and enhance long-term reliability.

Troubleshooting

CONDITION: Power indicator is off. Mains indicator is on.

POSSIBLE REASON

- The amplifier's Power switch is off.

Key

- Off
- ◐ Flashing
- Off/Flashing/On
- ☀ Lit

"Off/Flashing/On" above means that the LED can be off, or flashing, or on.

CONDITION: Power indicator is off. Mains indicator is off.

POSSIBLE REASON

- The power supply fuse has tripped.
- The amplifier has lost AC Power.
- The amplifier is not plugged in to the power receptacle.

CONDITION: Power indicator is flashing.

POSSIBLE REASON:

- The AC line voltage has dropped below 10% or has risen above 10% of the nominal line voltage of the power supply.
- When the Amp is in Sleep Mode as set by the AUX Port, the amplifier will not power up until the ground closure on the AUX Port is released. When the power button is pushed in this condition, the Power Indicator will flash for 2 – 3 seconds.

CONDITION: Thermal indicator is on.

POSSIBLE REASON:

- The amplifier is becoming too hot for safe operation. Allow amplifier to cool. Check for loads less than 2 ohms, and for excessive input levels. Check for proper ventilation and proper mode-switch setting.

CONDITION: Fault indicator is flashing.

POSSIBLE REASON:

- There are a number of conditions that result in the Fault indicator flashing: temperature above 98C, DC/LF protection is engaged, HF detect, output short circuit detected. These conditions should all be checked and attempted to be resolved before the amp is shipped back for service.

Troubleshooting

Fault —●—

Thermal —●—

Clip —●—

-10 —●—

-20 —●—

Signal —●—

Ready —●—

Bridge

Power —●—

Data —○—

CONDITION: Distorted sound.

POSSIBLE REASON:

- Load is wired incorrectly or Stereo/Bridge mode switch is set incorrectly. Check both.
- Input is overloaded by a signal level that is too high. Turn down your amplifier level controls, or turn down the input signal, until the clip light goes out.

Note: If the signal sounds distorted even though the Clip LED is off, the input signal may be distorted before it reaches the amplifier input. Check gain staging and output levels of the mixer or preamp.

Key	●	Off
	◐	Flashing
	○	Off/Flashing/On
	☀	Lit

“Off/Flashing/On” above means that the LED can be off, or flashing, or on.

Fault —●—

Thermal —●—

Clip —●—

-10 —●—

-20 —●—

Signal —●—

Ready —●—

Bridge

Power —●—

Data —○—

CONDITION: No sound, even though the amp has power. Power LED is on without flashing and the amp is receiving an input signal. Signal indicator is flashing.

POSSIBLE REASON:

- Speakers not connected.
- Open circuit due to speaker failure.

Fault —●—

Thermal —●—

Clip —○—

-10 —○—

-20 —○—

Signal —○—

Ready —●—

Bridge

Power —●—

Data —○—

- Based on the front panel LEDs, determine which channel has a short. Remove the associated input connector to ensure that no voltage will be present on the output. Remove the shorted load (and possibly attached cables) and have it checked by a qualified technician. If the shorted condition remains after the load is removed, the unit should be sent into a qualified service center.

Fault —●—

Thermal —●—

Clip —●—

-10 —●—

-20 —●—

Signal —●—

Ready —●—

Bridge

Power —●—

Data —●—

- Ready LED is off. Channel has been set to Sleep mode via the Aux port or Power Save mode.

Troubleshooting

Fault — ●
Thermal — ●
Clip — ●
-10 — ●
-20 — ●
Signal — ●
Ready — ☀️

Power ☀️
Data ○



Bridge ○

CONDITION: No input signal.
 Signal indicator is not flashing even though audio is applied, and the channel is ready.

POSSIBLE REASON:

- Input signal level is very low.

Key

- Off
- ☀️ Flashing
- Off/Flashing/On
- ☀️ Lit

“Off/Flashing/On” above means that the LED can be off, or flashing, or on.

Power ☀️
Data ●



Bridge ☀️

CONDITION: Bridge LED is lit.
POSSIBLE REASON:

- Amplifier is in bridge-mono mode.

DCi Specifications

Dual-Mode - All Channels Driven

DCi Model	Channels	2 Ohms	4 Ohms	8 Ohms	16 Ohms	70Vrms	100Vrms
2I300	2	150W	300W	300W	150W	300W	300W
2I600	2	300W	600W	600W	300W	600W	600W
4I300	4	150W	300W	300W	150W	300W	300W
4I600	4	300W	600W	600W	300W	600W	600W
8I300	8	150W	300W	300W	150W	300W	300W
8I600	8	300W	600W	600W	300W	600W	600W
2I1250	2	1250W	1250W	1250W	625W	1250W	1250W
4I1250	4	1250W	1250W	1250W	625W	1250W	1250W

Minimum Guaranteed Power (20 Hz - 20 kHz)

Bridge Mono Mode - All Channels Driven

DCi Model	4 Ohm	8 Ohms	16 Ohm	140Vrms	200Vrms
2I300	300W	600W	600W	600W	600W
2I600	600W	1200W	1200W	1200W	1200W
4I300	300W	600W	600W	600W	600W
4I600	600W	1200W	300W	1200W	1200W
8I300	300W	600W	600W	600W	600W
8I600	600W	1200W	1200W	1200W	1200W
2I1250	2500W	2500W	2500W	2500W	2500W
4I1250	2500W	2500W	2500W	2500W	2500W

Minimum Guaranteed Power (20 Hz - 20 kHz)

DCi Specifications

Input Sensitivity

DCi Model	8 Ohm	70V	100V
2I300	1.0V	1.4V	2.0V
2I600	1.4V	1.4V	2.0V
4I300	1.0V	1.4V	2.0V
4I600	1.4V	1.4V	2.0V
8I300	1.0V	1.4V	2.0V
8I600	1.4V	1.4V	2.0V
2I1250	2.0V	1.4V	2.0V
4I1250	2.0V	1.4V	2.0V

Dimensions

DCi Model	Width	Height	Depth
2I300	19 in. (48.3 cm)	3.5 in. (8.9 cm)	14.25 in. (36.2 cm)
2I600	19 in. (48.3 cm)	3.5 in. (8.9 cm)	14.25 in. (36.2 cm)
4I300	19 in. (48.3 cm)	3.5 in. (8.9 cm)	14.25 in. (36.2 cm)
4I600	19 in. (48.3 cm)	3.5 in. (8.9 cm)	14.25 in. (36.2 cm)
8I300	19 in. (48.3 cm)	3.5 in. (8.9 cm)	14.25 in. (36.2 cm)
8I600	19 in. (48.3 cm)	3.5 in. (8.9 cm)	17 in. (43.2 cm)
2I1250	19 in. (48.3 cm)	3.5 in. (8.9 cm)	14.25 in. (36.2 cm)
4I1250	19 in. (48.3 cm)	3.5 in. (8.9 cm)	17 in. (43.2 cm)

DCi Specifications

Performance Specifications

	2 300	2 600	4 300	4 600	8 300	8 600	2 1250	4 1250
Voltage Gain (at maximum level setting) 4/8 Ohm, 70V and 100V Operation	34dB							
Frequency Response (8 Ohms, 20 Hz - 20 kHz)	±0.25dB							
Signal to Noise Ratio (ref. rated power, (8 Ohms, 20 Hz - 20 kHz)	>108 dB							
Total Harmonic Distortion (at full rated power, from 20 Hz - 20 kHz)	0.35%							
Intermodulation Distortion (60Hz and 7 kHz at 4:1, from - 30dB to full rated Power)	≤0.35%							
Damping Factor (20 Hz to 100 Hz)	>1000							
Crosstalk (below rated power, 20 Hz to 1 kHz)	>80 dB							
Common Mode Rejection (20 Hz to 1 kHz, typical)	>70 dB							
DC Output Offset (with inputs shorted)	±10mV							
Input Impedance (Nominally balanced, nominally unbalanced)	10 kOhms, 5 kOhms							
Maximum Input Level Before Compression	+20dBu							
Maximum Input Level Before Clipping	+26dBu							
Required AC Mains (±10%)	100V - 240V~ 50/60Hz							
Cooling	Continuously variable speed forced air, front-to-back airflow							
Load Impedance Stereo/Dual Mode	2 - 16 Ohms; 70Vrms and 100Vrms							
Load Impedance Bridge Mono	4 - 16 Ohms; 140Vrms and 200Vrms							
Maximum Fan Noise (re dB SPL @ 1M)	45	45	45	45	47	47	47	47
Weight	18.8 lbs (8.53kg)	18.8 lbs (8.53kg)	20.1 lbs (9.12kg)	20.1 lbs (9.12kg)	23.5 lbs (10.66kg)	30 lbs (13.60kg)	20.1 lbs (9.12kg)	30 lbs (13.60kg)
IEC Power Connector	15A IEC	15A IEC	15A IEC	15A IEC	15A IEC	20A IEC	15A IEC	20A IEC

AC Power Draw and Thermal Dissipation

AC Power Draw and Thermal Dissipation:

Pink noise 12dB crest factor, bandwidth limited 22Hz to 22kHz.

Typical line impedance used.

Data based on all channels driven.

DCI 21300 - Bridge									
		120 V~ 60 Hz				230 V~ 50 Hz			
Condition	Load	Line Current (amps)	Power Dissipated as Heat			Line Current (amps)	Power Dissipated as Heat		
			watts	BTU	kcal/hr		watts	BTU	kcal/hr
At Idle Awake	N/A	0.6	70	239	60	0.4	70	240	60
1/8 Power Pink Noise Typical of program material just at clip	4 ohms	1.0	80	273	69	0.6	83	283	71
	8 ohms	1.4	86	294	74	0.8	88	300	76
	16 ohms	1.4	80	274	69	0.8	84	287	72
	140V (32.67 ohms)	1.3	78	265	67	0.8	80	273	69
	200V (66.67 ohms)	1.3	78	267	67	0.8	80	274	69
1/3 Power Pink Noise Typical of program material at extreme clip	4 ohms	1.8	107	364	92	1.0	102	348	88
	8 ohms	2.8	126	430	108	1.5	117	400	101
	16 ohms	2.7	108	367	93	1.4	101	345	87
	70V (32.67 ohms)	2.6	101	345	87	1.4	95	323	81
	100V (66.67 ohms)	2.6	99	338	85	1.4	94	321	81

DCI 21300 - Dual									
		120 V~ 60 Hz				230 V~ 50 Hz			
Condition	Load	Line Current (amps)	Power Dissipated as Heat			Line Current (amps)	Power Dissipated as Heat		
			watts	BTU	kcal/hr		watts	BTU	kcal/hr
At Idle Awake	N/A	0.6	70	238	60	0.4	70	238	60
1/8 Power Pink Noise Typical of program material just at clip	2 ohms	1.0	77	262	66	0.6	79	269	68
	4 ohms	1.4	84	287	72	0.8	84	288	73
	8 ohms	1.4	79	271	68	0.8	81	277	70
	70V (16.33 ohms)	1.3	79	268	68	0.8	80	273	69
	100V (33.33 ohms)	1.4	81	275	69	0.8	81	277	70
1/3 Power Pink Noise Typical of program material at extreme clip	2 ohms	1.8	99	338	85	1.0	96	329	83
	4 ohms	2.9	118	403	102	1.5	111	380	96
	8 ohms	2.6	102	347	87	1.4	96	327	83
	70V (16.33 ohms)	2.8	104	356	90	1.3	93	317	80
	100V (33.33 ohms)	2.6	105	358	90	1.4	98	336	85

AC Power Draw and Thermal Dissipation

AC Power Draw and Thermal Dissipation:

Pink noise 12dB crest factor, bandwidth limited 22Hz to 22kHz.

Typical line impedance used.

Data based on all channels driven.

DCI 21600 - Bridge									
		120 V~ 60 Hz				230 V~ 50 Hz			
Condition	Load	Line Current (amps)	Power Dissipated as Heat			Line Current (amps)	Power Dissipated as Heat		
			watts	BTU	kcal/hr		watts	BTU	kcal/hr
At Idle Awake	N/A	0.6	70	239	60	0.4	73	249	63
1/8 Power Pink Noise Typical of program material just at clip	2 ohms	1.5	93	318	80	0.8	97	330	83
	4 ohms	2.2	109	372	94	1.2	104	355	89
	8 ohms	2.1	101	345	87	1.1	94	320	81
	70V (16.33 ohms)	2.1	98	334	84	1.1	92	313	79
	100V (33.33 ohms)	2.1	92	316	80	1.1	90	308	78
1/3 Power Pink Noise Typical of program material at extreme clip	2 ohms	2.9	143	487	123	1.5	138	472	119
	4 ohms	4.8	174	592	149	2.6	171	585	147
	8 ohms	4.5	143	487	123	2.4	138	470	119
	70V (16.33 ohms)	4.5	143	488	123	2.4	135	462	116
	100V (33.33 ohms)	4.5	130	442	112	2.3	125	425	107

DCI 21600 - Dual									
		120 V~ 60 Hz				230 V~ 50 Hz			
Condition	Load	Line Current (amps)	Power Dissipated as Heat			Line Current (amps)	Power Dissipated as Heat		
			watts	BTU	kcal/hr		watts	BTU	kcal/hr
At Idle Awake	N/A	0.6	72	246	62	0.4	70	240	60
1/8 Power Pink Noise Typical of program material just at clip	2 ohms	1.5	93	318	80	0.8	91	310	78
	4 ohms	2.2	106	362	91	1.2	99	339	85
	8 ohms	2.1	95	324	82	1.1	90	307	77
	70V (16.33 ohms)	2.1	94	320	81	1.1	89	304	77
	100V (33.33 ohms)	2.1	93	318	80	1.1	87	297	75
1/3 Power Pink Noise Typical of program material at extreme clip	2 ohms	2.9	133	454	114	1.5	126	430	108
	4 ohms	4.7	156	533	134	2.4	147	502	126
	8 ohms	4.5	131	448	113	2.4	125	427	108
	70V (16.33 ohms)	4.5	132	450	113	2.4	123	421	106
	100V (33.33 ohms)	4.5	127	435	110	2.4	121	413	104

AC Power Draw and Thermal Dissipation

AC Power Draw and Thermal Dissipation:

Pink noise 12dB crest factor, bandwidth limited 22Hz to 22kHz.

Typical line impedance used.

Data based on all channels driven.

DCI 2 1250 - Bridge									
		120 V~ 60 Hz				230 V~ 50 Hz			
Condition	Load	Line Current (amps)	Power Dissipated as Heat			Line Current (amps)	Power Dissipated as Heat		
			watts	BTU	kcal/hr		watts	BTU	kcal/hr
At Idle Awake	N/A	0.8	96	329	83	0.5	91	311	78
1/8 Power Pink Noise Typical of program material just at clip	4 ohms	4.1	175	598	151	2.1	141	483	122
	8 ohms	4.2	142	485	122	2.2	127	434	109
	16 ohms	4.1	155	529	133	2.0	105	360	91
	140V (8 ohms)	3.9	143	486	123	2.1	141	481	121
	200V (16 ohms)	3.6	111	378	95	2.1	132	451	114
1/3 Power Pink Noise Typical of program material at extreme clip	4 ohms	9.6	276	943	238	5.0	233	796	201
	8 ohms	9.8	218	743	187	4.8	211	719	181
	16 ohms	9.5	204	696	176	4.9	209	715	180
	140V (8 ohms)	9.1	224	763	192	4.6	200	682	172
	200V (16 ohms)	8.7	160	546	138	4.7	208	711	179

DCI 2 1250 - Dual									
		120 V~ 60 Hz				230 V~ 50 Hz			
Condition	Load	Line Current (amps)	Power Dissipated as Heat			Line Current (amps)	Power Dissipated as Heat		
			watts	BTU	kcal/hr		watts	BTU	kcal/hr
At Idle Awake	N/A	0.8	97	330	83	0.5	91	311	78
1/8 Power Pink Noise Typical of program material just at clip	2 ohms	6.2	198	675	170	3.0	182	621	157
	4 ohms	5.1	143	489	123	2.5	138	469	118
	8 ohms	4.2	106	361	91	2.3	154	526	133
	70V (4 ohms)	4.1	132	450	113	2.1	126	430	108
	100V (8 ohms)	3.8	122	418	105	2.1	143	487	123
1/3 Power Pink Noise Typical of program material at extreme clip	2 ohms	11.4	275	938	237	6.4	314	1072	270
	4 ohms	10.4	220	750	189	5.2	235	802	202
	8 ohms	9.4	221	754	190	4.6	179	611	154
	70V (4 ohms)	9.0	260	886	223	4.6	197	672	169
	100V (8 ohms)	8.7	196	669	169	4.5	176	602	152

AC Power Draw and Thermal Dissipation

AC Power Draw and Thermal Dissipation:

Pink noise 12dB crest factor, bandwidth limited 22Hz to 22kHz.

Typical line impedance used.

Data based on all channels driven.

DCI 41300 - Bridge									
		120 V~ 60 Hz				230 V~ 50 Hz			
Condition	Load	Line Current (amps)	Power Dissipated as Heat			Line Current (amps)	Power Dissipated as Heat		
			watts	BTU	kcal/hr		watts	BTU	kcal/hr
At Idle Awake	N/A	1.0	119	405	102	0.6	121	414	104
1/8 Power Pink Noise Typical of program material just at clip	4 ohms	1.0	221	755	190	1.0	139	475	120
	8 ohms	1.4	298	1018	257	1.4	153	523	132
	16 ohms	1.4	300	1023	258	1.4	145	495	125
	140V (32.67 ohms)	1.3	289	987	249	1.3	137	467	118
	200V (66.67 ohms)	1.3	291	994	250	1.3	141	480	121
1/3 Power Pink Noise Typical of program material at extreme clip	4 ohms	3.5	199	681	172	1.8	190	649	164
	8 ohms	5.3	225	768	194	2.8	222	759	191
	16 ohms	5.1	201	685	173	2.7	190	647	163
	140V (32.67 ohms)	4.9	179	612	154	2.5	170	582	147
	200V (66.67 ohms)	5.0	185	633	160	2.5	174	594	150

DCI 41300 - Dual									
		120 V~ 60 Hz				230 V~ 50 Hz			
Condition	Load	Line Current (amps)	Power Dissipated as Heat			Line Current (amps)	Power Dissipated as Heat		
			watts	BTU	kcal/hr		watts	BTU	kcal/hr
At Idle Awake	N/A	1.0	118	401	101	0.6	119	408	103
1/8 Power Pink Noise Typical of program material just at clip	2 ohms	1.9	141	480	121	1.0	136	465	117
	4 ohms	2.6	156	532	134	1.4	149	507	128
	8 ohms	2.6	149	509	128	1.4	142	484	122
	70V (16.33 ohms)	2.5	143	489	123	1.3	139	475	120
	100V (33.33 ohms)	2.5	149	507	128	1.3	142	485	122
1/3 Power Pink Noise Typical of program material at extreme clip	2 ohms	3.4	194	661	167	1.8	184	629	159
	4 ohms	5.5	219	749	189	2.9	211	719	181
	8 ohms	5.0	191	653	165	2.6	181	618	156
	70V (16.33 ohms)	4.9	183	624	157	2.6	177	604	152
	100V (33.33 ohms)	5.0	197	673	170	2.6	191	652	164

AC Power Draw and Thermal Dissipation

AC Power Draw and Thermal Dissipation:

Pink noise 12dB crest factor, bandwidth limited 22Hz to 22kHz.

Typical line impedance used.

Data based on all channels driven.

DCI 41600 - Bridge									
		120 V~ 60 Hz				230 V~ 50 Hz			
Condition	Load	Line Current (amps)	Power Dissipated as Heat			Line Current (amps)	Power Dissipated as Heat		
			watts	BTU	kcal/hr		watts	BTU	kcal/hr
At Idle Awake	N/A	1.0	117	400	101	0.6	118	404	102
1/8 Power Pink Noise Typical of program material just at clip	4 ohms	2.9	185	631	159	1.5	173	592	149
	8 ohms	4.4	207	708	178	2.2	196	670	169
	16 ohms	4.0	183	625	158	2.1	175	596	150
	140V (16 ohms)	3.9	179	609	154	2.1	173	592	149
	200V (33.33 ohms)	3.9	167	571	144	2.1	163	556	140
1/3 Power Pink Noise Typical of program material at extreme clip	4 ohms	5.7	278	949	239	3.0	269	918	231
	8 ohms	9.6	344	1174	296	4.9	322	1099	277
	16 ohms	9.0	292	996	251	4.6	235	802	202
	140V (16 ohms)	9.0	289	988	249	4.6	259	884	223
	200V (33.33 ohms)	8.8	260	886	223	4.5	231	790	199

DCI 41600 - Dual									
		120 V~ 60 Hz				230 V~ 50 Hz			
Condition	Load	Line Current (amps)	Power Dissipated as Heat			Line Current (amps)	Power Dissipated as Heat		
			watts	BTU	kcal/hr		watts	BTU	kcal/hr
At Idle Awake	N/A	1.0	118	402	101	0.6	120	410	103
1/8 Power Pink Noise Typical of program material just at clip	2 ohms	3.0	182	622	157	1.5	168	575	145
	4 ohms	4.3	200	682	172	2.2	191	652	164
	8 ohms	4.0	174	595	150	2.2	168	573	144
	70V (16.33 ohms)	4.0	175	596	150	2.1	168	573	144
	100V (33.33 ohms)	4.0	169	578	146	2.1	162	554	140
1/3 Power Pink Noise Typical of program material at extreme clip	2 ohms	5.6	264	902	227	2.9	249	849	214
	4 ohms	9.4	316	1079	272	4.8	287	980	247
	8 ohms	8.9	266	907	229	4.6	240	820	207
	70V (16.33 ohms)	8.8	268	916	231	4.6	240	820	207
	100V (33.33 ohms)	8.8	256	872	220	4.6	231	789	199

AC Power Draw and Thermal Dissipation

AC Power Draw and Thermal Dissipation:

Pink noise 12dB crest factor, bandwidth limited 22Hz to 22kHz.

Typical line impedance used.

Data based on all channels driven.

DCI 4 1250 - Bridge									
		120 V~ 60 Hz				230 V~ 50 Hz			
Condition	Load	Line Current (amps)	Power Dissipated as Heat			Line Current (amps)	Power Dissipated as Heat		
			watts	BTU	kcal/hr		watts	BTU	kcal/hr
At Idle Awake	N/A	1.5	178	607	153	0.9	180	615	155
1/8 Power Pink Noise Typical of program material just at clip	4 ohms	8.2	287	980	247	4.1	281	961	242
	8 ohms	7.8	254	866	218	4.0	232	791	200
	16 ohms	8.0	262	896	226	4.1	224	766	193
	140V (8 ohms)	7.7	266	908	229	4.0	234	799	201
	200V (16 ohms)	7.8	256	874	220	3.9	255	871	220
1/3 Power Pink Noise Typical of program material at extreme clip	4 ohms	18.0	528	1802	454	9.4	497	1697	428
	8 ohms	17.9	416	1419	358	9.5	362	1237	312
	16 ohms	17.6	401	1367	345	8.9	308	1052	265
	140V (8 ohms)	17.1	375	1278	322	8.7	364	1242	313
	200V (16 ohms)	17.0	366	1250	315	8.8	313	1067	269

DCI 4 1250- Dual									
		120 V~ 60 Hz				230 V~ 50 Hz			
Condition	Load	Line Current (amps)	Power Dissipated as Heat			Line Current (amps)	Power Dissipated as Heat		
			watts	BTU	kcal/hr		watts	BTU	kcal/hr
At Idle Awake	N/A	1.5	178	607	153	0.9	180	615	155
1/8 Power Pink Noise Typical of program material just at clip	2 ohms	10.4	363	1237	312	4.4	259	884	223
	4 ohms	9.0	253	862	217	4.4	257	878	221
	8 ohms	8.4	268	913	230	4.3	244	832	210
	70V (4 ohms)	7.2	204	695	175	4.0	238	811	205
	100V 8 ohms)	7.9	216	738	186	3.8	216	738	186
1/3 Power Pink Noise Typical of program material at extreme clip	2 ohms	20.6	531	1813	457	9.9	458	1564	394
	4 ohms	19.5	497	1697	428	9.8	393	1342	338
	8 ohms	18.0	421	1436	362	9.1	331	1130	285
	70V (4 ohms)	16.6	384	1311	331	8.6	337	1150	290
	100V (8 ohms)	17.0	377	1286	324	8.7	313	1069	270

AC Power Draw and Thermal Dissipation

AC Power Draw and Thermal Dissipation:

Pink noise 12dB crest factor, bandwidth limited 22Hz to 22kHz.

Typical line impedance used.

Data based on all channels driven.

DCI 81300 - Bridge									
		120 V~ 60 Hz				230 V~ 50 Hz			
Condition	Load	Line Current (amps)	Power Dissipated as Heat			Line Current (amps)	Power Dissipated as Heat		
			watts	BTU	kcal/hr		watts	BTU	kcal/hr
At Idle Awake	N/A	1.9	221	755	190	1.0	216	739	186
1/8 Power Pink Noise Typical of program material just at clip	4 ohms	3.5	273	932	235	1.9	248	847	213
	8 ohms	4.9	292	998	252	2.6	276	943	238
	16 ohms	4.8	267	910	229	2.6	259	885	223
	140V (32.67 ohms)	4.7	262	893	225	2.5	242	824	208
	200V (66.67 ohms)	4.6	254	867	219	2.5	252	858	216
1/3 Power Pink Noise Typical of program material at extreme clip	2 ohms	6.7	381	1300	328	3.4	341	1165	294
	4 ohms	10.4	436	1488	375	5.4	401	1369	345
	8 ohms	9.8	374	1277	322	5.1	337	1152	290
	70V (16.33 ohms)	9.4	335	1142	288	4.9	291	995	251
	100V (33.33 ohms)	9.6	347	1185	299	4.7	297	1013	255

DCI 81300 - Dual									
		120 V~ 60 Hz				230 V~ 50 Hz			
Condition	Load	Line Current (amps)	Power Dissipated as Heat			Line Current (amps)	Power Dissipated as Heat		
			watts	BTU	kcal/hr		watts	BTU	kcal/hr
At Idle Awake	N/A	1.8	214	731	184	1.0	216	738	186
1/8 Power Pink Noise Typical of program material just at clip	2 ohms	3.3	223	762	192	1.9	243	831	210
	4 ohms	5.0	288	982	248	2.7	279	951	240
	8 ohms	4.9	270	920	232	2.5	263	896	226
	70V (16.33 ohms)	4.8	267	911	230	2.5	262	895	226
	100V (33.33 ohms)	4.8	274	936	236	2.6	272	927	234
1/3 Power Pink Noise Typical of program material at extreme clip	2 ohms	5.7	263	897	226	3.4	331	1131	285
	4 ohms	10.3	417	1423	359	5.3	392	1337	337
	8 ohms	10.0	372	1269	320	5.0	341	1165	294
	70V (16.33 ohms)	9.9	366	1250	315	5.0	346	1180	297
	100V (33.33 ohms)	10.0	395	1348	340	5.1	361	1233	311

AC Power Draw and Thermal Dissipation

AC Power Draw and Thermal Dissipation:

Pink noise 12dB crest factor, bandwidth limited 22Hz to 22kHz.

Typical line impedance used.

Data based on all channels driven.

DCI 81600 - Bridge									
		120 V~ 60 Hz				230 V~ 50 Hz			
Condition	Load	Line Current (amps)	Power Dissipated as Heat			Line Current (amps)	Power Dissipated as Heat		
			watts	BTU	kcal/hr		watts	BTU	kcal/hr
At Idle Awake	N/A	1.8	210	718	181	1.0	211	721	182
1/8 Power Pink Noise Typical of program material just at clip	4 ohms	5.5	328	1118	282	2.8	318	1084	273
	8 ohms	8.2	332	1132	285	4.2	305	1042	263
	16 ohms	8.1	303	1032	260	3.8	266	909	229
	140V (32.67 ohms)	7.4	279	952	240	3.8	270	923	233
	200V (66.67 ohms)	7.3	262	895	226	3.8	253	862	217
1/3 Power Pink Noise Typical of program material at extreme clip	2 ohms	10.5	451	1538	388	5.4	437	1493	376
	4 ohms	17.7	516	1760	444	9.0	440	1503	379
	8 ohms	17.3	425	1449	365	8.8	374	1278	322
	70V (16.33 ohms)	16.9	412	1408	355	8.6	368	1255	316
	100V (33.33 ohms)	16.7	369	1258	317	8.5	311	1061	267

DCI 81600 - Dual									
		120 V~ 60 Hz				230 V~ 50 Hz			
Condition	Load	Line Current (amps)	Power Dissipated as Heat			Line Current (amps)	Power Dissipated as Heat		
			watts	BTU	kcal/hr		watts	BTU	kcal/hr
At Idle Awake	N/A	1.9	215	733	185	1.0	207	705	178
1/8 Power Pink Noise Typical of program material just at clip	2 ohms	5.8	333	1136	286	2.9	325	1110	280
	4 ohms	8.5	356	1214	306	4.3	336	1147	289
	8 ohms	8.2	311	1061	267	4.2	290	990	250
	70V (16.33 ohms)	7.5	283	964	243	3.9	287	979	247
	100V (33.33 ohms)	7.8	281	959	242	4.0	267	912	230
1/3 Power Pink Noise Typical of program material at extreme clip	2 ohms	11.0	466	1589	401	5.7	486	1658	418
	4 ohms	19.0	587	2004	505	9.6	558	1906	481
	8 ohms	17.5	448	1529	385	8.8	388	1324	334
	70V (16.33 ohms)	17.1	441	1504	379	8.6	379	1294	326
	100V (33.33 ohms)	16.6	381	1301	328	8.5	344	1173	296

Service

Crown amplifiers are quality units that rarely require servicing. Before returning your unit for service, please contact Crown Technical Support to verify the need for servicing.

This unit has very sophisticated circuitry which should only be serviced by a fully trained technician. This is one reason why each unit bears the following label:



CAUTION: To prevent electric shock, do not remove covers. No user serviceable parts inside. Refer servicing to a qualified technician.

Complete the Crown Audio Factory Service Information form, in the back of this manual, when returning a Crown product to the factory or authorized service center. The form must be included with your product inside the box or in a packing slip envelope securely attached to the outside of the shipping carton. Do not send this form separately.

International and Canada Service

Service may be obtained from an authorized service center. (Contact your local Crown/Amcron representative or our office for a list of authorized service centers.) To obtain service, simply present the bill of sale as proof of purchase along with the defective unit to an authorized service center. They will handle the necessary paperwork and repair. Remember to transport your unit in the original factory pack

US Service

Service may be obtained in one of two ways: from an authorized service center or from the factory. You may choose either. It is important that you have your copy of the bill of sale as your proof of purchase.

Service at a US Service Center

This method usually saves the most time and effort. Simply present your bill of sale along with the defective unit to an authorized service center to obtain service. They will handle the necessary paperwork and repair. Remember to transport the unit in the original factory pack. A list of authorized service centers in your area can be obtained from Crown Factory Service, or online from <http://www.crownaudio.com/support/servcent.htm>.

Factory Service

Crown accepts no responsibility for non-serviceable product that is sent to us for factory repair. Contact Crown Customer Service to verify the product is still serviceable prior to returning for factory service.

For more information, please contact us directly.

A Service Return Authorization (SRA) is required for product being sent to the factory for repair. An SRA can be completed online at <http://www.crownaudio.com/rma.html>. If you do not have access to the web, please call Crown's Customer Service at 574.294.8200 or 800.342.6939 extension 4907 in North America, Puerto Rico and the Virgin Islands only.

For warranty service, we will pay for ground shipping both ways in the United States. Contact Crown Customer Service to obtain prepaid shipping labels prior to sending the unit. Or, if you prefer, you may prepay the cost of shipping, and Crown will reimburse you. Send copies of the shipping receipts to Crown to receive reimbursement.

Your repaired unit will be returned via UPS ground. Please contact us if other arrangements are required.

Factory Service Shipping Instructions:

1. Service Return Authorization (SRA) is required for product being sent to the factory for service. Please complete the SRA by going to www.crownaudio.com/support/factserv.htm. If you do not have access to our website, call 1.800.342.6939, extension 4907 and we'll create the SRA for you.
2. See packing instructions that follow.
3. Ship product to:
CROWN AUDIO FACTORY SERVICE
1718 W MISHAWKA RD.
ELKHART, IN 46517

Service

4. Use a bold black marker and write the SRA number on three sides of the box.
5. Record the SRA number for future reference. The SRA number can be used to check the repair status.

Packing Instructions

Important: These instructions must be followed. If they are not followed, Crown Audio, Inc. assumes no responsibility for damaged goods and/or accessories that are sent with your unit.

1. Fill out and include the Crown Audio Factory Service Information sheet in the back of this manual.
2. Do not ship any accessories (manuals, cords, hardware, etc.) with your unit. These items are not needed to service your product. We will not be responsible for these items.
3. When shipping your Crown product, it is important that it has adequate protection. We recommend you use the original pack material when returning the product for repair. If you do not have the original box, please call Crown at 1-800-342-6939 or 1-574-294-8210 and order new pack material. (Do not ship your unit in a wood or metal cabinet.)
4. If you provide your own shipping pack, the minimum recommended requirements for materials are as follows:
 - a. 275 P.S.I. burst test, Double-Wall carton that allows for 2-inch solid Styrofoam on all six sides of unit or 3 inches of plastic bubble wrap on all six sides of unit.
 - b. Securely seal the package with an adequate carton sealing tape.
 - c. DO NOT USE LIGHT BOXES OR "PEANUTS". DAMAGE CAUSED BY POOR PACKAGING WILL NOT BE COVERED UNDER WARRANTY.

Enclose the completed Crown Audio Factory Service Information form (or securely attach it to the outside of carton) and re-seal the shipping pack with a sturdy carton sealing tape.

Payment of Non-Warranty Repairs

Payment on out-of-warranty repairs must be received within 30 days of the repair date. Units unclaimed after 30 days become the property of Crown Audio Inc.

If you have any questions, please contact Crown Factory Service.

Crown Factory Service

1718 W. Mishawaka Rd.,
Elkhart, Indiana 46517 U.S.A.

Telephone:

574-294-8200
800-342-6939 (North America, Puerto Rico, and Virgin Islands only)

Facsimile:

574-294-8301 (Technical Support)
574-294-8124 (Factory Service)

Web site:

<http://www.crownaudio.com>

Warranty



SUMMARY OF WARRANTY

Crown International, 1718 West Mishawaka Road, Elkhart, Indiana 46517-4095 U.S.A. warrants to you, the ORIGINAL PURCHASER and ANY SUBSEQUENT OWNER of each NEW Crown product, for a period of three (3) years from the date of purchase by the original purchaser (the “warranty period”) that the new Crown product is free of defects in materials and workmanship. We further warrant the new Crown product regardless of the reason for failure, except as excluded in this Warranty.

**Warranty is only valid within the United States of America. For information on Warranty outside of the U.S.A., please contact your local distributor.*

ITEMS EXCLUDED FROM THIS CROWN WARRANTY

This Crown Warranty is in effect only for failure of a new Crown product which occurred within the Warranty Period. It does not cover any product which has been damaged because of any intentional misuse, accident, negligence, or loss which is covered under any of your insurance contracts. This Crown Warranty also does not extend to the new Crown product if the serial number has been defaced, altered, or removed.

WHAT THE WARRANTOR WILL DO

We will remedy any defect, regardless of the reason for failure (except as excluded), by repair, replacement, or refund. We may not elect refund unless you agree, or unless we are unable to provide replacement, and repair is not practical or cannot be timely made. If a refund is elected, then you must make the defective or malfunctioning product available to us free and clear of all liens or other encumbrances. The refund will be equal to the actual purchase price, not including interest, insurance, closing costs, and other finance charges less a reasonable depreciation on the product from the date of original purchase. Warranty work can only be performed at our authorized service centers or at the factory. Warranty work for some products can only be performed at our factory. We will remedy the defect and ship the product from the service center or our factory within a reasonable time after receipt of the defective product at our authorized service center or our factory. All expenses in remedying the defect, including surface shipping costs in the United States, will be borne by us. (You must bear the expense of shipping the product between any foreign country and the port of entry in the United States including the return shipment, and all taxes, duties, and other customs fees for such foreign shipments.)

HOW TO OBTAIN WARRANTY SERVICE

You must notify us of your need for warranty service within the warranty period. All components must be shipped in a factory pack, which, if needed, may be obtained from us free of charge. Corrective action will be taken within a reasonable time of the date of receipt of the defective product by us or our authorized service center. If the repairs made by us or our authorized service center are not satisfactory, notify us or our authorized service center immediately.

DISCLAIMER OF CONSEQUENTIAL AND INCIDENTAL DAMAGES

YOU ARE NOT ENTITLED TO RECOVER FROM US ANY INCIDENTAL DAMAGES RESULTING FROM ANY DEFECT IN THE NEW CROWN PRODUCT. THIS INCLUDES ANY DAMAGE TO ANOTHER PRODUCT OR PRODUCTS RESULTING FROM SUCH A DEFECT. SOME STATES DO NOT ALLOW THE EXCLUSION OR LIMITATIONS OF INCIDENTAL OR CONSEQUENTIAL DAMAGES, SO THE ABOVE LIMITATION OR EXCLUSION MAY NOT APPLY TO YOU.

WARRANTY ALTERATIONS

No person has the authority to enlarge, amend, or modify this Crown Warranty. This Crown Warranty is not extended by the length of time which you are deprived of the use of the new Crown product. Repairs and replacement parts provided under the terms of this Crown Warranty shall carry only the unexpired portion of this Crown Warranty.

DESIGN CHANGES

We reserve the right to change the design of any product from time to time without notice and with no obligation to make corresponding changes in products previously manufactured.

LEGAL REMEDIES OF PURCHASER

THIS CROWN WARRANTY GIVES YOU SPECIFIC LEGAL RIGHTS, YOU MAY ALSO HAVE OTHER RIGHTS WHICH VARY FROM STATE TO STATE. No action to enforce this Crown Warranty shall be commenced after expiration of the warranty period.

THIS STATEMENT OF WARRANTY SUPERSEDES ANY OTHERS CONTAINED IN THIS MANUAL FOR CROWN PRODUCTS.
03/13

Crown Audio Factory Service Information

Shipping Address: Crown Audio Factory Service, 1718 W. Mishawaka Rd., Elkhart, IN 46517

PLEASE PRINT CLEARLY

SRA #: _____ (If sending product to Crown factory service.)
Model: _____ Serial Number: _____ Purchase Date: _____

PRODUCT RETURN INFORMATION

Individual or Business Name: _____
Phone #: _____ Fax #: _____ E-Mail: _____
Street Address (please, no P.O. Boxes): _____
City: _____ State/Prov: _____ Postal Code: _____ Country: _____
Nature of problem: _____

Other equipment in your system: _____

If warranty is expired, please provide method of payment. Proof of purchase may be required to validate warranty.

PAYMENT OPTIONS

- I have open account payment terms. Purchase order required. PO#: _____ COD
- Credit Card (Information below is required; however if you do not want to provide this information at this time, we will contact you when your unit is repaired for the information.)

Credit card information:

Type of credit card: MasterCard Visa American Express Discover

Type of credit card account: Personal/Consumer Business/Corporate

Card # _____ Exp. date: _____ *Card ID #: _____

*Card ID # is located on the back of the card following the credit card #, in the signature area. On American Express, it may be located on the front of the card. This number is required to process the charge to your account. If you do not want to provide it at this time, we will call you to obtain this number when the repair of your unit is complete.

Name on credit card: _____

Billing address of credit card: _____



PRODUCT REGISTRATION

Crown Audio, Inc.
1718 W. Mishawaka Rd.
Elkhart, IN 46517-9439
Phone: 574-294-8000
Fax: 574-294-8329
www.crownaudio.com

Warranty is only valid within the country in which the product is purchased.

When this form is used to register your product, it may be mailed or faxed.

Crown Audio, Inc. Fax: 574-294-8329
1718 W Mishawaka Rd
Elkhart IN 46517

Please note that some information is required. Incomplete registrations will not be processed. * Indicates required information.

OWNER'S INFORMATION – PLEASE PRINT

* First name: _____ Middle initial: _____ * Last name: _____
Company: _____
* Mailing address: _____
* City: _____ * State: _____ * Zip Code: _____
* Country: _____ E-mail address: _____
* Phone # (include area code): _____ Fax #: _____

PRODUCT INFORMATION

* MODEL e.g. IT8000, CDi1000, PCC16	* SERIAL # e.g. 800000000	* PURCHASE DATE mo/day/yr
_____	_____	___/___/___
_____	_____	___/___/___
_____	_____	___/___/___
_____	_____	___/___/___

Product purchased from: *(Business/Individual) _____ Country: _____

Comments: _____

CUT ON THIS LINE

