

Crestron **SWAMP(I)-24X8**  
Sonnex<sup>®</sup> Multiroom Audio System

---

Operations Guide



## Important Safety Instructions

- Read these instructions.
- Keep these instructions.
- Heed all warnings.
- Follow all instructions.
- Do not use this apparatus near water.
- Clean only with dry cloth.
- Do not block any ventilation openings. Install in accordance with the manufacturer's instructions.
- Do not install near any heat sources such as radiators, heat registers, stoves, or other apparatus (including amplifiers) that produce heat.
- Do not defeat the safety purpose of the polarized or grounding-type plug. A polarized plug has two blades with one wider than the other. A grounding-type plug has two blades and a third grounding prong. The wide blade or the third prong are provided for your safety. If the provided plug does not fit into your outlet, consult an electrician for replacement of the obsolete outlet.
- Protect the power cord from being walked on or pinched particularly at plugs, convenience receptacles, and the point where they exit from the apparatus.
- Only use attachments/accessories specified by the manufacturer.
- Use only with the cart, stand, tripod, bracket or table specified by the manufacturer or sold with the apparatus. When a cart is used, use caution when moving the cart/apparatus combination to avoid injury from tip-over. 
- Unplug this apparatus during lightning storms or when unused for long periods of time.
- Refer all servicing to qualified service personnel. Servicing is required when the apparatus has been damaged in any way, such as power-supply cord or plug is damaged, liquid has been spilled or objects have fallen into the apparatus, the apparatus has been exposed to rain or moisture, does not operate normally, or has been dropped.
- Disconnect power prior to connecting or disconnecting equipment.
- Do not install in direct sunlight.
- The apparatus must be installed in a way that the power cord can be removed either from the wall outlet or from the device itself in order to disconnect the mains power.
- Prevent foreign objects from entering the device.

### WARNING:

---

TO REDUCE THE RISK OF FIRE OR ELECTRIC SHOCK, DO NOT EXPOSE THIS APPARATUS TO RAIN OR MOISTURE. THE APPARATUS SHALL NOT BE EXPOSED TO DRIPPING OR SPLASHING. OBJECTS FILLED WITH LIQUIDS, SUCH AS VASES, SHOULD NOT BE PLACED ON THE APPARATUS.

---

### WARNING:

---

TO PREVENT ELECTRIC SHOCK, DO NOT REMOVE COVER. THERE ARE NO USER SERVICEABLE PARTS INSIDE. ONLY QUALIFIED SERVICE PERSONNEL SHOULD PERFORM SERVICE.

---



The lightning flash with arrowhead symbol, within an equilateral triangle, is intended to alert the user to the presence of uninsulated "dangerous voltage" within the product's enclosure that may be of sufficient magnitude to constitute a risk of electric shock to persons.



The exclamation point within an equilateral triangle is intended to alert the user to the presence of important operating and maintenance (servicing) instructions in the literature accompanying the appliance.

### WARNING:

---

THIS IS AN APPARATUS WITH CLASS I CONSTRUCTION. IT SHALL BE CONNECTED TO AN ELECTRICAL OUTLET WITH AN EARTHING GROUND TERMINAL.

---

### IMPORTANT:

---

These devices can be used with Class 2 output wiring.

---

## Regulatory Compliance

These products conform to UL 60065; certified to CSA C22.2 No. 60065.03.



As of the date of manufacture, the SWAMP-24X8 and SWAMPI-24X8 have been tested and found to comply with specifications for CE marking.



---

## Federal Communications Commission (FCC) Compliance Statement

This device complies with part 15 of the FCC Rules. Operation is subject to the following conditions:

(1) This device may not cause harmful interference and (2) this device must accept any interference received, including interference that may cause undesired operation.

**CAUTION:** Changes or modifications not expressly approved by the manufacturer responsible for compliance could void the user's authority to operate the equipment.

**NOTE:** This equipment has been tested and found to comply with the limits for a Class B digital device, pursuant to part 15 of the FCC Rules. These limits are designed to provide reasonable protection against harmful interference in a residential installation. This equipment generates, uses and can radiate radio frequency energy and, if not installed and used in accordance with the instructions, may cause harmful interference to radio communications. However, there is no guarantee that interference will not occur in a particular installation. If this equipment does cause harmful interference to radio or television reception, which can be determined by turning the equipment off and on, the user is encouraged to try to correct the interference by one or more of the following measures:

- Reorient or relocate the receiving antenna
- Increase the separation between the equipment and receiver
- Connect the equipment into an outlet on a circuit different from that to which the receiver is connected
- Consult the dealer or an experienced radio/TV technician for help

---

## Industry Canada (IC) Compliance Statement

CAN ICES-3(B)/NMB-3(B)

---

The specific patents that cover Crestron products are listed at [patents.crestron.com](http://patents.crestron.com).

Crestron, the Crestron logo, ADMS Intermedia Delivery System, AIR, Aspire, Cresnet, Crestron Home, Crestron Studio, Crestron Toolbox, Essence, Excite, Fusion RV, Saros, Sonnex, Sonnex Speaker Protect, and SSP are either trademarks or registered trademarks of Crestron Electronics, Inc. in the United States and/or other countries. iPod is either a trademark or registered trademark of Apple Computer, Inc., in the United States and/or other countries. Other trademarks, registered trademarks, and trade names may be used in this document to refer to either the entities claiming the marks and names or their products. Crestron disclaims any proprietary interest in the marks and names of others. *Crestron is not responsible for errors in typography or photography.*

This document was written by the Technical Publications department at Crestron.  
©2014 Crestron Electronics, Inc.



# Contents

<b>Sonnex Multiroom Audio System: SWAMP(I)-24X8</b>	<b>1</b>
Introduction .....	1
Features and Functions .....	1
Applications.....	7
Specifications .....	8
Physical Description .....	11
Setup .....	17
Network Wiring.....	17
Sonnex Link Wiring .....	17
Identity Code .....	17
Installation.....	18
Hardware Hookup .....	20
Configuration.....	26
Source Setup.....	26
Zone Setup.....	27
Expander Status .....	35
Amplifier Status .....	36
Network Setup.....	36
Control Setup.....	39
About.....	40
Uploading and Upgrading.....	41
Establishing Communication.....	41
Programs and Firmware .....	42
Program Checks .....	43
Operation .....	44
Power.....	44
Operating Modes .....	44
Volume Control.....	45
Problem Solving .....	46
Troubleshooting.....	46
Check Network Wiring.....	46
Reference Documents.....	47
Further Inquiries .....	47
Future Updates .....	47
Return and Warranty Policies .....	49
Merchandise Returns / Repair Service .....	49
Crestron Limited Warranty.....	49



# Sonnex Multiroom Audio System: SWAMP(I)-24X8

---

## Introduction

The SWAMP-24X8 is the centerpiece of a fully scalable audio distribution system that delivers high-output audiophile sound quality to every room with significantly reduced cabling, low power consumption, advanced DSP, and integrator-friendly setup. The Sonnex<sup>®</sup> Multiroom Audio System takes audio distribution to a higher level, facilitating massive systems with up to 74 zones and over 30,000 watts of power.

Employing a unique system topology, Sonnex minimizes speaker wiring distances by allowing expansion units to be placed central to the rooms they serve. Twenty-four stereo channels of uncompressed digital audio and control are routed to each expander over a single inexpensive shielded CAT5e cable.\* Gone is all the clutter of amplifier interconnects and input loop-thru cables, integrating eight zones of high-performance power amplification and signal processing, plus input switching for a generous 24 analog and digital sources, all in one compact 4-space rack-mountable package.

The SWAMP-24X8 and SWAMPI-24X8 are functionally identical. For simplicity within this guide, the term “SWAMP-24X8” is used except where noted.

## Features and Functions

- Advanced multiroom audio distribution for homes and businesses
- Robust, high-efficiency audiophile grade amplification built in
- 140 watts/channel @ 8 ohms , 400 watts/channel bridged
- Provides eight amplified stereo zone outputs
- Provides two additional S/PDIF stereo zone outputs

*(Continued on following page)*

\* For connection of the Sonnex Link between the SWAMP-24X8 and each expander, use Crestron<sup>®</sup> DM-CBL-8G or high-quality CAT5e shielded twisted-pair cable. The maximum cable length using DM-CBL-8G or CAT5e is 200 ft (61 m) per run. For longer distances, use the S-EXT1-S Sonnex Link over Fiber Extender (sold separately).

## Features and Functions

*(Continued)*

- Additional line-level, S/PDIF, and “CH” CAT5 balanced outputs available<sup>1</sup>
- 70/100 Volt “constant-voltage” output options available
- Output bussing enables linked operation of multiple adjacent zones
- Bridgeable outputs provide extra power for pools and other large areas
- Sonnex Link provides a 1-wire, plug-and-play interface to eight SWAMPE expanders up to 200 feet (61 meters) away<sup>2,3</sup>
- Sonnex Link over Fiber Extender S-EXT1-S (sold separately) enables distances up to 2000 feet (610 meters)
- Includes 12 unbalanced, 4 balanced/unbalanced, and 8 S/PDIF inputs
- Supports direct audio connection of the CEN-IDOCV Docking Interface (sold separately) and other “CH” CAT5 sources<sup>4</sup>
- Allows audio return channel capability and extension of line-level and S/PDIF signals using AUD-EXT Audio Extenders
- User adjustable volume, bass, treble, loudness, and selectable tone profiles
- Installer adjustable 5-band graphic or parametric EQ per zone
- Dynamic Range Control maintains even listening levels in both quiet and loud ambient environments
- Speaker Profiles allow upload of custom preset speaker settings
- Sonnex Speaker Protect<sup>®</sup> output limiting affords extra headroom while preventing component damage
- Individual zone power control and global standby
- Setup and adjustment via front panel or Sonnex Tools software
- Remote fault monitoring
- Seamless Crestron<sup>®</sup> system integration
- Heavy duty detachable terminal blocks ease speaker wire termination
- Low power consumption, cool-running operation
- 4-space 19” rack-mountable

1. Additional S/PDIF and analog line outputs may be added using the SWE-8 Sonnex Multiroom Audio Unamplified Expander (sold separately).
2. For connection of the Sonnex Link between the SWAMP-24X8 and each expander, use Crestron DM-CBL-8G or high-quality CAT5e shielded twisted-pair cable. The maximum cable length using DM-CBL-8G or CAT5e is 200 ft (61 m) per run. For longer distances, use the S-EXT1-S Sonnex Link over Fiber Extender (sold separately).
3. If using Cresnet<sup>®</sup> as the control system interface, system expansion is limited to one expander. Support for more than one expander requires Ethernet as the control system interface.
4. CH (Crestron Home<sup>®</sup>) CAT5 balanced audio is supported using balanced inputs 13 – 16. All other inputs require an ABAR-1 CAT5 Balanced Audio Receiver.



### ***Integrated Audiophile Amplifier***

The amplifiers in the SWAMP-24X8 use a custom hybrid amplifier design that achieves the warmth and neutrality of a fine Class AB amplifier with all of the efficiency benefits of modern Class D.

Each of the SWAMP-24X8's 16 channels (configured as eight stereo zones) delivers 140 watts into 8 ohms, or 240 watts into 4 ohms. For large, noisy areas around the pool or patio, or in a game room or gym, any two adjacent outputs can be bridged (Zone 1 + Zone 2, Zone 3 + Zone 4, Zone 5 + Zone 6, Zone 7 + Zone 8) to produce 400 watts per channel at 8 ohms. The SWAMP-24X8 uses only four rack spaces while maintaining effective cooling with no need for extra clearance above or below. Each zone is individually controllable, saving further energy by turning off any unused channels.

### ***24x8 Matrix Switcher***

Designed with flexibility and expansion in mind, the Sonnex Multiroom Audio System provides numerous inputs to manage a multitude of stereo audio sources, both analog and digital.

- A total of 24 discrete inputs are spread across an array of connectors, including unbalanced RCA, balanced terminal blocks, and S/PDIF coaxial. Sonnex easily handles the multizone outputs from a Crestron ADMS Intermedia Delivery System™ or TunerRack Modular Multi-Tuner (CEN-TRACK), plus digital television receivers and other devices.
- Audio return channels are easily added using Crestron AUD-EXT Audio Extenders to receive signals from remote AV receivers located up to 2000 feet (610 m) away.
- Sonnex even accepts a direct input from the CEN-IDOCV Interface for iPod® and other Crestron Home® CAT5 Balanced sources without requiring a separate converter.<sup>1</sup>

For ease of use, descriptive names for every source input and zone output can be displayed on the front panel LCD and pushbuttons. Via the front panel controls, or from a Crestron touch screen or remote, any input can be selected for listening in any zone or group. Additional features include mono summing for distribution to non-stereo zones, scaling factor settings for defining minimum and maximum volume levels, source signal detection, and source gain compensation to assure a consistent level when switching between disparate sources.

### ***Bonus Zones***

In addition to its eight amplified zone outputs, the SWAMP-24X8 provides two additional S/PDIF digital outputs for sharing stereo sources with centralized audio processors and AV receivers.<sup>2</sup> These outputs can even be extended to feed remote AV receivers anywhere in the house using AUD-EXT Audio Extenders.

1. CH (Crestron Home) CAT5 balanced audio is supported using balanced inputs 13 – 16. All other inputs require an ABAR-1 CAT5 Balanced Audio Receiver.
2. Additional S/PDIF and analog line outputs may be added using the SWE-8 Sonnex Multiroom Audio Unamplified Expander (sold separately).

### ***Sonnex Digital Audio Transport***

Among the many features that set Sonnex apart from all other multiroom systems is the Sonnex Audio Transport. On the rear of the SWAMP-24X8 are eight Sonnex Link ports, enabling the connection of up to eight Sonnex Multiroom Audio Expanders (SWAMPE-4 or SWAMPE-8).<sup>1</sup> Each link transports professional-quality 24-bit, 48 kHz digital audio from all 24 inputs simultaneously to each expander, supporting wiring distances up to 200 feet (61 meters) over a single CAT5e shielded twisted-pair (STP) cable.<sup>2</sup>

While the expanders can be installed centrally with the SWAMP-24X8, the ease of running just one tiny wire instead of 16 heavy speaker cables clearly affords a much better decentralized system approach. Installing each expander local to the rooms it serves, whether on a different floor, another wing, or a completely separate building, significantly reduces the amount of speaker wiring needed to install. The benefits of reducing speaker wiring include faster, easier, and less expensive installation, as well as overall higher performance and efficiency by minimizing the signal loss inherent in long speaker runs.

### ***Plug and Play Expansion***

Control for each expander is also embedded in the Sonnex Link, dramatically simplifying installation and setup through a true 1-wire interface. There is no need to set addresses or write any special programming. Simply connect each expander to the SWAMP-24X8 and instantly control the complete system from the SWAMP-24X8's front panel or Sonnex Tools software.

### ***Advanced DSP***

To truly deliver an ultimate listening experience in every room, Sonnex includes built-in digital signal processing, providing a virtual arsenal of controls and adjustments, intelligently deployed to streamline both the installer setup procedure and day-to-day user operation. Key setup functions are accessible via the front panel, while more advanced settings are provided via Sonnex Tools software. Naturally, the essential user controls can be made available on any Crestron touch screen, keypad, handheld remote, or mobile device as part of a complete Crestron system.

The following features are included in Sonnex DSP:

- User Controls allow a Crestron touch screen or other user interface to provide the essential controls for day-to-day listening. Controls include room volume, bass, treble, balance, loudness, mute, zone on/off, and five selectable tone profiles. Through the control system program, many advanced user functions are possible including priority modes (who can control which sources), zone grouping (source sharing), paging, do-not-disturb, alarm clock, sleep timer, and much more.
- Tone Profiles allow users to select from five preset EQ curves including Classical, Jazz, Pop, Rock, or Spoken Word, each tailored for a different type of material or listening preference.

1. If using Cresnet as the control system interface, system expansion is limited to one expander. Support for more than one expander requires Ethernet as the control system interface.

2. For connection of the Sonnex Link between the SWAMP-24X8 and each expander, use Crestron DM-CBL-8G or high-quality CAT5e shielded twisted-pair cable. The maximum cable length using DM-CBL-8G or CAT5e is 200 ft (61 m) per run. For longer distances, use the S-EXT1-S Sonnex Link over Fiber Extender.

- Dynamic Range Control (DRC) is a user-selectable feature to help keep everything at a consistent level, whether in a quiet bedroom, a loud swimming pool, or an outdoor patio, facilitating a more cohesive listening experience.
- Sonnex Speaker Protect® (SSP) output limiting assures maximum headroom while preventing damage to the amplifier or speakers. SSP® output limiting lets the installer set the protection to match the speakers' power handling capability, achieving a transparent effect right up to the limits of the speaker device.

---

**CAUTION:** As speaker ratings vary greatly across manufacturers, there is no guarantee that SSP protects against speaker damage in all situations.

---

- 5-Band Equalizer provides the choice of graphic or parametric 5-band EQ. Using Sonnex Tools software and a wireless laptop, the installer can easily move from room to room, sculpting the sound for optimal audio clarity and impact.

### ***Speaker Profiles***

The Speaker Profiles feature in Sonnex Tools alleviates many repetitive adjustments from room-to-room, and project-to-project, by allowing installers to save a complete set of EQ and SSP settings for each type of speaker, room, and customer. Tuning a complete project can be as simple as loading the appropriate Speaker Profile for each zone, effectively pre-tuning the whole system before a single note of music or test signal is even played.

### ***Output Bussing***

The spacious, open floor plans typical of today's homes and businesses commonly present multiple adjacent listening zones with no sonic boundary between them such as a kitchen and dinette, a living room and dining room, or an outdoor pool and terrace. One click in Sonnex Tools instantly busses adjacent zones together to function as one group while preserving the individual speaker profile settings. Volume offset adjustments easily allow for balancing the levels of each bussed zone for smooth, even coverage of the complete space.

### ***Passive Subwoofer Support***

Sonnex provides extended low frequency performance in any room, providing high-performance bi-amplification capability to support a passive in-wall, in-floor, or freestanding subwoofer. Configuring Sonnex to handle a 2.1 speaker system is both simple and powerful, offering the choice of 2<sup>nd</sup> or 4<sup>th</sup> order active crossover filters for each sub and satellite output, plus up to four parametric EQ filters for room correction and tonal enhancement. With 400 watts available in bridged mode, there is plenty of power on hand to fill any room with deep, gratifying bass.\*

Active (powered) subwoofers are supported using the SWE-8 Sonnex Multiroom Audio Unamplified Expander (sold separately).

\* Passive subwoofer support requires one zone output to drive the main left and right (i.e., satellite) speakers, plus one additional zone output to drive a subwoofer with 140 watts @ 8 ohms, or two additional zone outputs bridged to drive a subwoofer with 400 watts @ 8 ohms.

### ***Unamplified Outputs***

For applications requiring line level zone outputs, Crestron offers the SWE-8 Sonnex Multiroom Audio Unamplified Expander (sold separately). Each SWE-8 provides an assortment of analog line level, S/PDIF digital, and Crestron Home (CH) CAT5 balanced audio outputs, offering a solution for routing audio to AV receivers, powered subwoofers, headphone amplifiers, phone systems (for music-on-hold), and other audio equipment.

### ***70/100 V Option***

Any amplified zone output can be converted to 70- or 100-volt output using one or more Sonnex Output Transformers (SAT-70V/100V-2 or SAT-70V/100V-4, sold separately). A 70/100 V (constant-voltage) speaker system allows for the connection of numerous speakers per circuit and long wire runs using small-gauge wire. Typical applications include outdoor speaker zones, commercial retail spaces, hallways, and common areas.

### ***Intelligent Monitoring and Protection***

To help ensure the most seamless user experience and long-lived operation, Sonnex includes several ways to keep tabs on its operating status and health. On its own, Sonnex possesses the intelligence to protect itself from many types of faults including over temperature, over current, over voltage, under voltage, and dc offset on any channel. In the event of a fault, the front panel LCD provides clear fault indication to speed the troubleshooting of incorrect wiring, poor rack ventilation, and other unforeseen issues. Fault alerts may also be sent to a system touch screen or mobile device, and integrators can even monitor and track the data remotely through Crestron's Fusion RV<sup>®</sup> software to ensure a rapid service response.

### ***Ultimate Integration***

Without question, Sonnex delivers unprecedented intelligence from source to speaker. Via Cresnet<sup>®\*</sup> or high-speed Ethernet, Sonnex affords incredible integration potential as part of a complete Crestron system, enabling seamless control of every room and source through a wide selection of touch screens, keypads, wireless remotes, computers, and mobile devices. Complete setup is afforded via USB or Ethernet, using Sonnex Tools software, part of the Crestron Toolbox<sup>™</sup> installer toolkit.

\* If using Cresnet as the control system interface, system expansion is limited to one expander. Support for more than one expander requires Ethernet as the control system interface.

### Applications

The following diagram shows a SWAMP-24X8 in a multizone application.

*SWAMP-24X8 in a Multizone Application*

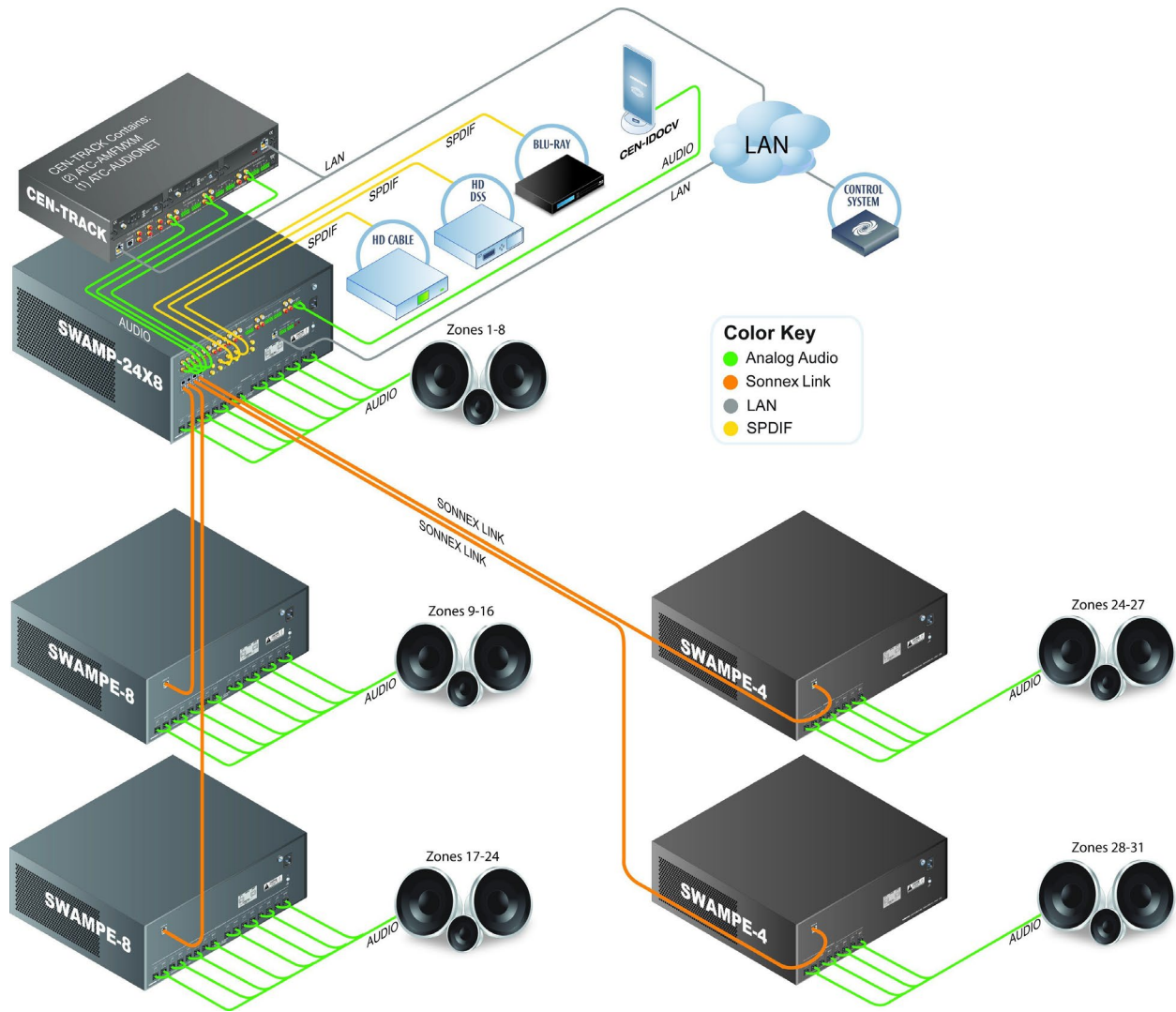

## Specifications

Specifications for the SWAMP(I)-24X8 are listed in the following table.

### *SWAMP(I)-24X8 Specifications*

<b>SPECIFICATION</b>	<b>DETAILS</b>
Audio	
Features	24 x 10 stereo matrix switcher, 8-channel stereo DSP, 8-channel stereo power amplifier, Sonnex Digital Audio Transport, speaker profiles, Sonnex Speaker Protect, 5-band graphic or parametric EQ, Dynamic Range Control (DRC), tone profiles, source gain compensation, amp bridging, output bussing, individual zone power control, global standby, source signal detection, amplifier temperature and fault monitoring, priority modes, <sup>1</sup> paging, <sup>1</sup> do-not-disturb, <sup>1</sup> alarm clock, and sleep timer <sup>1</sup>
Input Signal Types	Stereo analog line (unbalanced and balanced), S/PDIF coaxial (2-channel PCM only)
Output Signal Types	Stereo speaker level, S/PDIF coaxial (2-channel PCM only), Sonnex Link
Analog-to-Digital Conversion <sup>2</sup>	24-bit 48 kHz
Source Compensation <sup>2</sup>	±10.0 dB per input
Input Monitoring <sup>2</sup>	Source Signal Detect
Digital-to-Analog Conversion <sup>3</sup>	24-bit 48 kHz
Output Power <sup>3</sup>	140 watts per channel at 8 ohms 240 watts per channel at 4 ohms 400 watts per channel at 8 ohms bridged
Damping Factor <sup>3</sup>	> 200 @ 20 Hz
Amplifier Monitoring <sup>3</sup>	Over Current, Over/Under Voltage, Over Temperature, DC Offset, Clipping
Frequency Response <sup>3</sup>	20 Hz to 20 kHz, ±0.5 dB
Total Harmonic Distortion (THD) <sup>3</sup>	0.02%
S/N Ratio <sup>3</sup>	>105 dB S/PDIF in, >100 dB balanced or unbalanced analog in, A-weighted
Stereo Separation <sup>3</sup>	> 90 dB
Zone Separation <sup>3</sup>	> 95 dB
Zone Volume Level Control <sup>3</sup>	-80.0 to +20.0 dB, adjustable from 0% to 100% plus mute
Bass Control <sup>3</sup>	±12.0 dB
Treble Control <sup>3</sup>	±12.0 dB
Loudness Compensation <sup>3</sup>	On/Off
Dynamic Range Control <sup>3</sup>	On/Off
Balance Control <sup>3</sup>	Left/right adjustable
Mono Summing <sup>3</sup>	Selectable

*(Continued on following page)*

*SWAMP(I)-24X8 Specifications (Continued)*

SPECIFICATION	DETAILS
Audio (continued)	
Power Limiting <sup>3</sup>	Sonnex Speaker Protect (SSP) output limiting; Configurable 40 to 140 watts @ 8 ohms 40 to 240 watts @ 4 ohms 40 to 400 watts @ 8 ohms bridged
Tone Profiles <sup>3</sup>	Flat, Classical, Jazz, Pop, Rock, Spoken Word
EQ Modes <sup>3</sup>	5-band graphic or 5-band parametric EQ
GEQ Center Frequencies <sup>3</sup>	63 Hz, 250 Hz, 1 kHz, 4 kHz, 16 kHz
GEQ Gain <sup>3</sup>	±12.0 dB per band
PEQ Filter Types <sup>3</sup>	EQ, High Pass, Low Pass, Treble Shelf, Bass Shelf, Notch
PEQ Center Frequency <sup>3</sup>	10 to 20,000 Hz per band
PEQ Gain <sup>3</sup>	±12.0 dB per band
PEQ Bandwidth <sup>3</sup>	0.1 to 3.5 octaves per band
Speaker Profiles <sup>3</sup>	Comprises 5-band GEQ and SSP settings
Bus Volume Offset <sup>3</sup>	±12.0 dB per zone for output bussing
Resolution/Bitrate <sup>4</sup>	24-bit 48 kHz
Communications	
Ethernet	For control and console, 10/100 Mbps, auto-switching, auto-negotiating, auto-discovery, full/half duplex, DHCP
Cresnet	For control and console Cresnet slave <sup>5</sup>
Sonnex Link	64-channel (48 utilized) digital audio with embedded control, auto-discovery, auto-negotiating
Power Requirements	
Main Power	
SWAMP-24X8	12 amps @ 120 volts ac, 50/60 Hz
SWAMPI-24X8	6 amps @ 220-240 volts ac, 50/60 Hz
Cresnet Power Usage	None
Environmental	
Temperature	41° to 104° F (5° to 40° C)
Humidity	10% to 90% RH (non-condensing)
Heat Dissipation	475 Btu/h (140 watts @ 8 ohms) 750 Btu/h (240 watts @ 4 ohms)
Enclosure	
Chassis	Metal with black finish, vented sides, variable-speed fan-cooled
Front Panel	Metal, black finish with polycarbonate label overlay
Mounting	Freestanding or 4U 19-inch rack-mountable (feet and rack ears included)

*(Continued on following page)*

*SWAMP(I)-24X8 Specifications (Continued)*

SPECIFICATION	DETAILS
Dimensions	
Height	7.51 in (191 mm) with feet 6.97 in (178 mm) without feet
Width	19.00 in (483 mm) with ears 17.29 in (439 mm) without ears
Depth	18.47 in (470 mm)
Weight	60.0 lb (27.3 kg)
Available Models	
SWAMP-24X8	Sonnex Multiroom Audio System
SWAMPI-24X8	Sonnex Multiroom Audio System – International Version
Available Accessories	
AIR Series	AIR® Surface Mount Outdoor Speakers
ASPIRE Series	Aspire® Speakers
AUD-EXT	Audio Extenders
CBL Series	Crestron Certified Interface Cables
DM-8G-CONN	Cable Connector for DM-CBL-8G
DM-8G-CONN-WG	Cable Connector with Wire Guide for DM-CBL-8G
DM-8G-CRIMP	Crimping Tool for DM-8G-CONN
DM-8G-CRIMP-WG	Crimping Tool for DM-8G-CONN-WG
DM-CBL-8G	High-Performance CAT5e Shielded Twisted-Pair Cable
ESSENCE Series	Essence® Speakers
EXCITE Series	Excite® Speakers
S-EXT1-S	Sonnex Link Over Fiber Extender
SAROS Series	Saros® Speakers
SAT-70V/100V	Sonnex Output Transformer
SWAMPE-4	Sonnex Multiroom Audio Expander, 4-Zone
SWAMPE-8	Sonnex Multiroom Audio Expander, 8-Zone
SWE-8	Sonnex Multiroom Audio Unamplified Expander, 8-Zone

1. Feature enabled via control system program.
2. Typical of 24 stereo inputs.
3. Typical of up to eight amplified stereo zone outputs.
4. Typical of two digital stereo zone outputs.
5. If using Cresnet as the control system interface, system expansion is limited to one expander. Support for more than one expander requires Ethernet as the control system interface.



### Physical Description

This section provides information on the connections, controls, and indicators available on the SWAMP-24X8.

*SWAMP-24X8 Physical View (Front)*



*SWAMP-24X8 Physical View (Rear)*

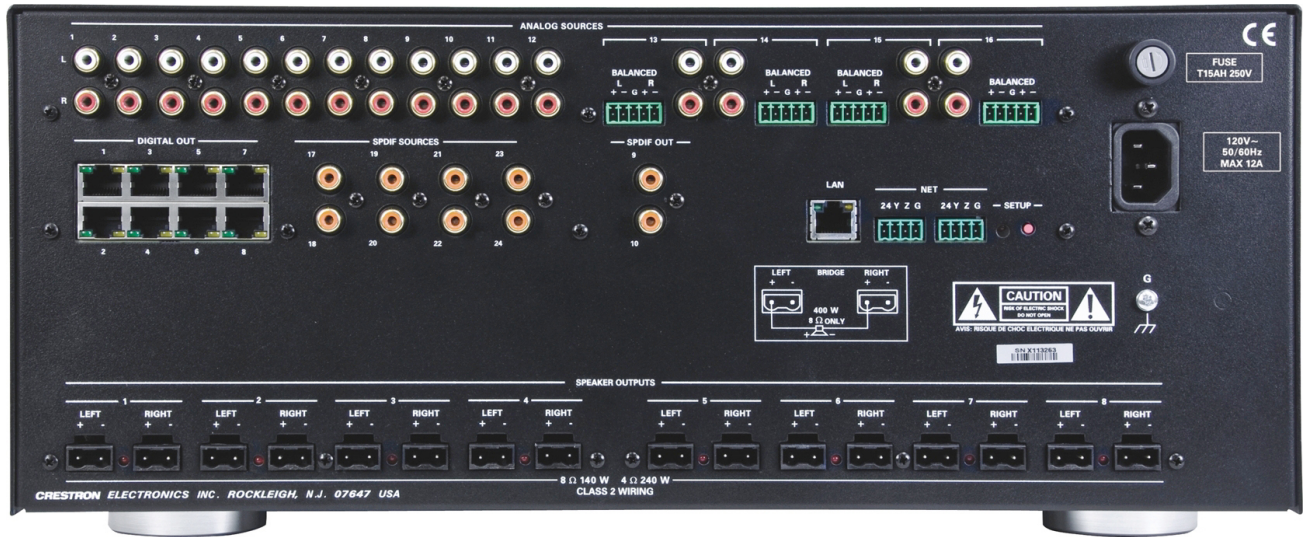

*SWAMP-24X8 Overall Dimensions (Top)*

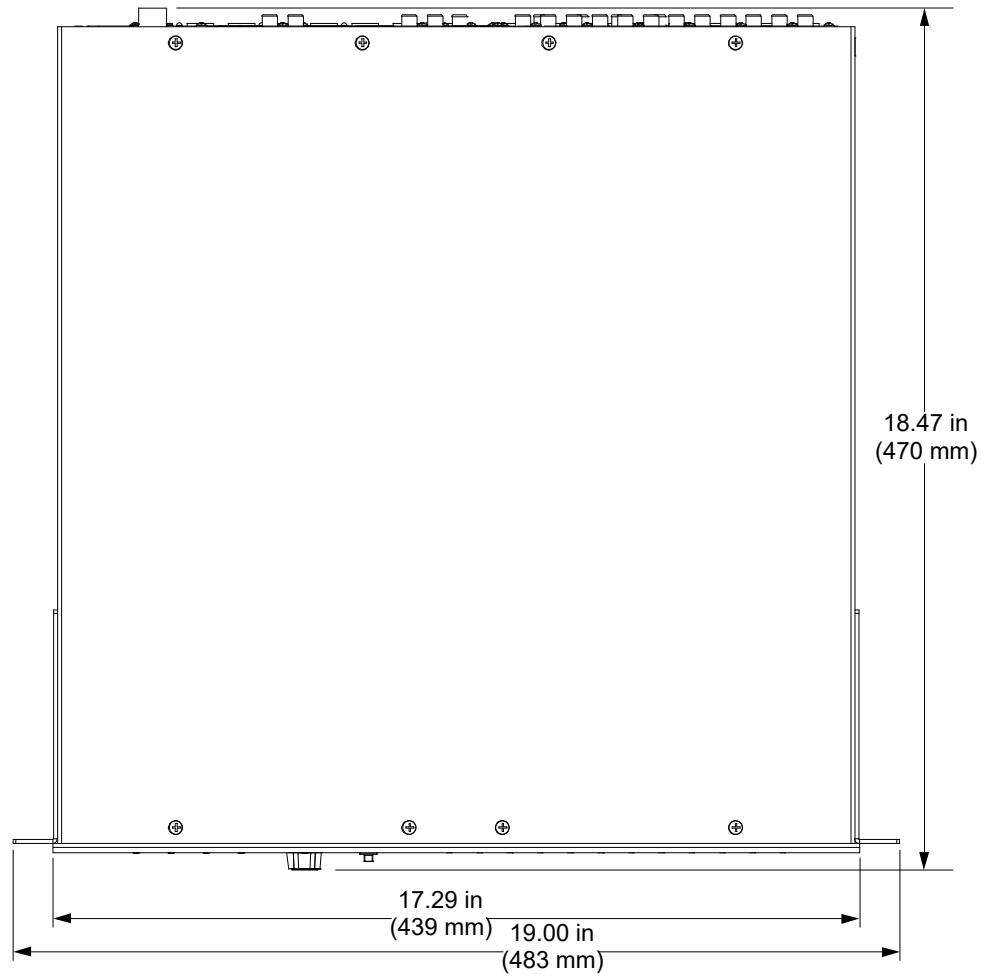

*SWAMP-24X8 Overall Dimensions (Front and Back)*

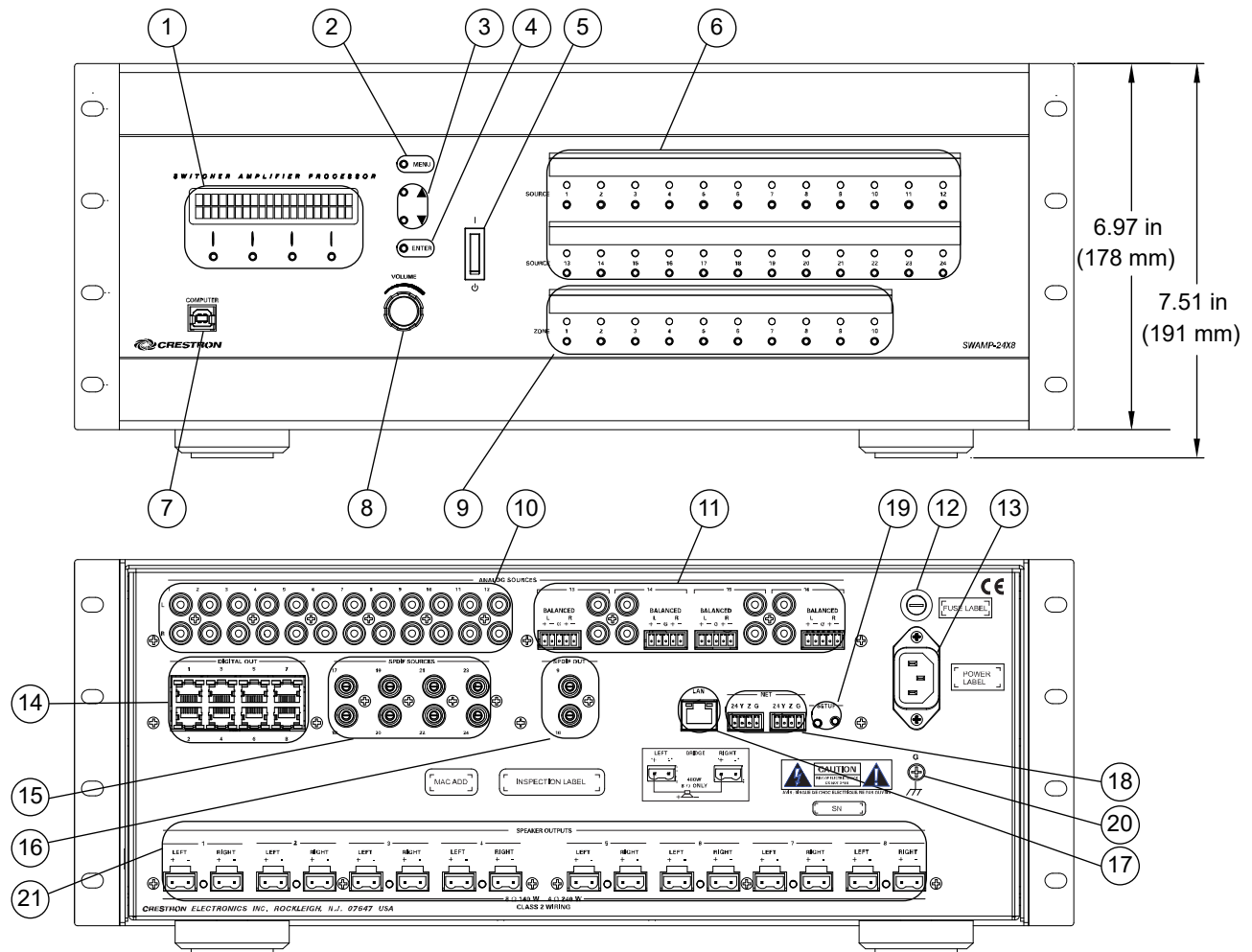



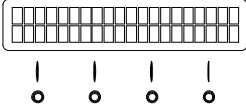



**Connectors, Controls, and Indicators**

#	CONNECTORS, <sup>1</sup> CONTROLS, AND INDICATORS	DESCRIPTION
1	LCD Display and BUTTONS 	Green LCD alphanumeric, adjustable backlight, 2 lines x 20 characters per line; Displays source and zone setup, amplifier and expander status, network and control configuration, volume levels, and other parameters; (4) Push buttons for execution of LCD driven functions
2	MENU	(1) Push button, steps menu back one level

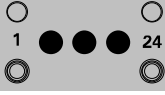
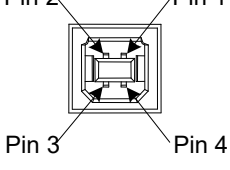

*(Continued on following page)*

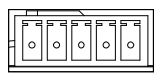
*Connectors, Controls, and Indicators (Continued)*

#	CONNECTORS, <sup>1</sup> CONTROLS, AND INDICATORS	DESCRIPTION										
3	Up, Down  	(2) Push buttons, scroll up or down through menu and adjust menu parameters										
4	ENTER	(1) Push button, executes highlighted menu item or value										
5	On/Off 	(1) Rocker switch, turns power amplifier on and off and resets the unit										
6	SOURCE (1-24) Buttons and LEDs 	(24) Push buttons and green LEDs, select input source for routing and adjustment										
7	COMPUTER 	USB Type B female, USB computer console port (6 ft cable included)										
		<table border="1"> <thead> <tr> <th>PIN</th> <th>DESCRIPTION</th> </tr> </thead> <tbody> <tr> <td>1</td> <td>+5 Vdc</td> </tr> <tr> <td>2</td> <td>Data -</td> </tr> <tr> <td>3</td> <td>Data +</td> </tr> <tr> <td>4</td> <td>Ground</td> </tr> </tbody> </table>	PIN	DESCRIPTION	1	+5 Vdc	2	Data -	3	Data +	4	Ground
PIN	DESCRIPTION											
1	+5 Vdc											
2	Data -											
3	Data +											
4	Ground											
8	VOLUME 	(1) Continuous turn rotary encoder, adjusts menu parameters, defaults to audio volume										
9	ZONE (1-10) Buttons and LEDs 	(10) Push buttons and green LEDs, select output zone for routing and adjustment										
10	ANALOG SOURCES L/R (1-16) 	(32) RCA female comprising (16) unbalanced stereo line level audio inputs; Input Impedance: 10 kilohms; Maximum Input Level: 2 Vrms										
11	ANALOG SOURCES BALANCED (13-16) BALANCED L R + - G + - 	(4) 5-pin 3.5 mm detachable terminal blocks Balanced stereo line level audio inputs (mutually exclusive of corresponding unbalanced inputs); Input Impedance: 20 kilohms; Maximum Input Level: 4 Vrms										

*(Continued on following page)*

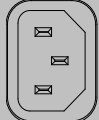
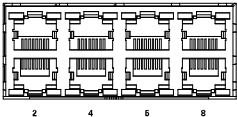
*Connectors, Controls, and Indicators (Continued)*

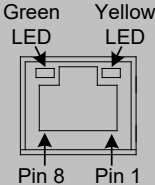
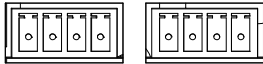
#	CONNECTORS, <sup>1</sup> CONTROLS, AND INDICATORS	DESCRIPTION																		
12	FUSE 	US/North America: T15AH (1/4" x 1-1/4", 250 V, 15 A, time-lag, high-rupture rated) fuse <sup>2</sup> ; International: T8AH (5 mm x 20 mm, 250 V, 8 A, time-lag, high-rupture rated) fuse <sup>2</sup>																		
13	120V~50/60Hz MAX 12A <sup>3</sup> 	(1) IEC 60320 C14, main power inlet; Mates with removable power cord (included)																		
14	DIGITAL OUT (1-8) 	(8) 8-wire RJ-45 female; Sonnex expansion link outputs; Green LED indicates link status; Amber LED indicates data communication on the corresponding output; Connect to Sonnex Multiroom Audio Expanders <sup>4,5</sup> (sold separately)																		
15	S/PDIF SOURCES (17-24) 	(8) RCA female; S/PDIF coaxial digital audio inputs; Input Impedance: 75 ohms																		
16	S/PDIF OUT (9-10) 	(2) RCA female; S/PDIF coaxial digital audio outputs; Output Impedance: 75 ohms																		
17	LAN Green LED    Yellow LED 	(1) 8-wire RJ-45 female; 10BASE-T/100BASE-TX Ethernet port; Green LED indicates link status; Yellow LED indicates Ethernet activity																		
		<table border="1"> <thead> <tr> <th>PIN</th> <th>SIGNALS</th> </tr> </thead> <tbody> <tr> <td>1</td> <td>TX +</td> </tr> <tr> <td>2</td> <td>TX -</td> </tr> <tr> <td>3</td> <td>RX +</td> </tr> <tr> <td>4</td> <td>Connected to pin 5</td> </tr> <tr> <td>5</td> <td>Connected to pin 4</td> </tr> <tr> <td>6</td> <td>RX -</td> </tr> <tr> <td>7</td> <td>Connected to pin 8</td> </tr> <tr> <td>8</td> <td>Connected to pin 7</td> </tr> </tbody> </table>	PIN	SIGNALS	1	TX +	2	TX -	3	RX +	4	Connected to pin 5	5	Connected to pin 4	6	RX -	7	Connected to pin 8	8	Connected to pin 7
PIN	SIGNALS																			
1	TX +																			
2	TX -																			
3	RX +																			
4	Connected to pin 5																			
5	Connected to pin 4																			
6	RX -																			
7	Connected to pin 8																			
8	Connected to pin 7																			
18	NET 24 Y Z G    24 Y Z G 	(2) 4-pin 3.5 mm detachable terminal blocks Cresnet slave ports, paralleled <sup>5</sup>  <b>24:</b> Power (24 Vdc) <b>Y:</b> Data <b>Z:</b> Data <b>G:</b> Ground  <b>NOTE:</b> The NET port does not supply or consume power.																		

*(Continued on following page)*

*Connectors, Controls, and Indicators (Continued)*

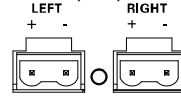
#	CONNECTORS, <sup>1</sup> CONTROLS, AND INDICATORS	DESCRIPTION
19	SETUP (LED and button)	(1) Recessed miniature push button and (1) red LED, used for touch-settable ID (TSID) in conjunction with Crestron Toolbox software
20	GROUND 	(1) 6-32 screw, chassis ground lug
21	SPEAKER OUTPUTS (1-8) 	(16) 2-pin 7.62 mm 15 A detachable terminal blocks; Power amplifier outputs; Wire Size: Terminals accept up to 14 AWG; The following outputs can be bridged together: 1 and 2 (L+R), 3 and 4 (L+R), 5 and 6 (L+R), 7 and 8 (L+R); Red LED indicates bridged operation  <b>NOTE:</b> Outputs can only be bridged into an 8 ohm load.

- Interface connectors for **NET**, **ANALOG SOURCES (BALANCED)**, and **SPEAKER OUTPUTS** ports are provided with the unit.
- Refer to “Fuse Replacement” on page 25 for additional details.
- Port on SWAMP(I)-24X8 is labeled **220-240V~50/60Hz MAX 6A**.
- For connection of the Sonnex Link between the SWAMP-24X8 and each expander, use Crestron DM-CBL-8G or high-quality CAT5e shielded twisted-pair cable. The maximum cable length using DM-CBL-8G or CAT5e is 200 ft (61 m) per run. For longer distances, use the S-EXT1-S Sonnex Link over Fiber Extender (sold separately).
- If using Cresnet as the control system interface, system expansion is limited to one expander. Support for more than one expander requires Ethernet as the control system interface.

---

## Setup

### Network Wiring

When wiring the Cresnet network, consider the following:

- Use Crestron Certified Wire.
- Use Crestron power supplies for Crestron equipment.
- Provide sufficient power to the system.

---

**CAUTION:** Insufficient power can lead to unpredictable results or damage to the equipment. Please use the Crestron Power Calculator to help calculate how much power is needed for the system ([www.crestron.com/calculators](http://www.crestron.com/calculators)).

---

For Cresnet networks with 20 or more devices, use a Cresnet Hub/Repeater (CNXHUB) to maintain signal quality.

---

**NOTE:** If using Cresnet for communications between the SWAMP-24x8 and a control system, only one expander can be connected.

---

For more details, refer to “Check Network Wiring” on page 46.

The SWAMP-24X8 can also use high-speed Ethernet for communications between the device and a control system, computer, digital media server and other IP-based devices.

For general information on connecting Ethernet devices in a Crestron system, refer to the Crestron e-Control® Reference Guide (Doc. 6052), at [www.crestron.com/manuals](http://www.crestron.com/manuals).

### Sonnex Link Wiring

Crestron recommends using Crestron DM-CBL-8G or high-quality CAT5e shielded twisted-pair cable for connections between the SWAMP-24X8 and expanders.

---

**NOTE:** Shielded connectors such as the DM-8G-CONN must be used.

---

DM-CBL-8G wire can carry Sonnex Link signals up to 200 feet (61 meters). If additional length is needed, the S-EXT1-S can extend the Sonnex link up to 2000 feet (610 meters) over one multimode fiber strand. The S-EXT1-S is an optional accessory that provides high performance signal extension.

### Identity Code

---

**NOTE:** The latest software can be downloaded at [www.crestron.com/software](http://www.crestron.com/software).

---

#### Net ID

The Net ID of the SWAMP-24X8 has been factory set to **A1**. The Net IDs of multiple SWAMP-24X8 devices in the same system must be unique. The Net ID can be set from the SWAMP-24X8’s front panel or with Crestron Toolbox. For more details, refer to “Set the Cresnet ID” on page 39 or the Crestron Toolbox help file.

When setting the Net ID, consider the following:

- The Net ID of each unit must match an ID code specified in the Crestron Studio™ or SIMPL Windows program.
- Each network device must have a unique Net ID.

#### IP ID

The IP ID is set from the SWAMP-24X8's front panel or within the SWAMP-24X8's IP table using Crestron Toolbox. For more details, refer to "Set the IP ID" which starts on page 39 or the Crestron Toolbox help file. The IP IDs of multiple SWAMP-24X8 devices in the same system must be unique.

When setting the IP ID, consider the following:

- The IP ID of each unit must match an IP ID specified in the Crestron Studio or SIMPL Windows program.
- Each device using IP to communicate with a control system must have a unique IP ID.

## Installation

#### Ventilation

The SWAMP-24X8 should be used in a well-ventilated area. The venting holes should not be obstructed under any circumstances.

To prevent overheating, do not operate this product in an area that exceeds the environmental temperature range listed in the table of specifications. Consider using forced air ventilation or incrementing the spacing between units to reduce overheating. Contact with thermal insulating materials should be avoided on all sides of the unit.

#### Rack Mounting

The SWAMP-24X8 can be mounted in a rack or stacked with other equipment. Two "ears" are provided with the SWAMP-24X8 so that the unit can be rack mounted. These ears must be installed prior to mounting. Complete the following procedure to attach the ears to the unit. The only tool required is a #1 or #2 Phillips screwdriver.

---

**WARNING:** To prevent bodily injury when mounting or servicing this unit in a rack, observe the following guidelines:

- When mounting this unit in a partially filled rack, load the rack from the bottom to the top with the heaviest component at the bottom of the rack.
- If the rack is provided with stabilizing devices, install the stabilizers before mounting or servicing the unit in the rack.

**NOTE:** Observe the following guidelines when installing equipment in a rack:

- **Elevated Operating Ambient Temperature** - If installed in a closed or multi-unit rack assembly, the operating ambient temperature of the rack environment may be greater than room ambient temperature. Therefore, consideration should be given to installing the equipment in an environment compatible with the maximum ambient temperature (T<sub>ma</sub>) specified by the manufacturer.
- **Reduced Air Flow** - Installation of the equipment in a rack should be such that the amount of airflow required for safe operation of the equipment is not compromised.
- **Mechanical Loading** - Mounting of the equipment in the rack should be such that a hazardous condition is not achieved due to uneven mechanical loading.



- **Circuit Overloading** - Consideration should be given to the connection of the equipment to the supply circuit and the effect that overloading of the circuits might have on overcurrent protection and supply wiring. Appropriate consideration of equipment nameplate ratings should be used when addressing this concern.
- **Reliable Earthing** - Reliable earthing of rack-mounted equipment should be maintained. Particular attention should be given to supply connections other than direct connections to the branch circuit (e.g., use of power strips)

**NOTE:** Feet are preinstalled for tabletop mounting or stacking. If the unit is to be rack mounted, the feet are not required and can be removed to provide more space in the rack.

To install the ears, use the following procedure.

**CAUTION:** To prevent equipment damage, use only the rack ears Crestron provides for this device.

1. There are screws that secure each side of the SWAMPE-8 top cover. Using a #1 or #2 Phillips screwdriver, remove the three screws closest to the front panel from one side of the unit. Refer to the diagram following step 3 for a detailed view.
2. Position a rack ear so that its mounting holes align with the holes vacated by the screws in step 1.
3. Secure the ear to the unit with three screws from step 1, as shown in the following diagram.

***Ear Attachment for Rack Mounting***

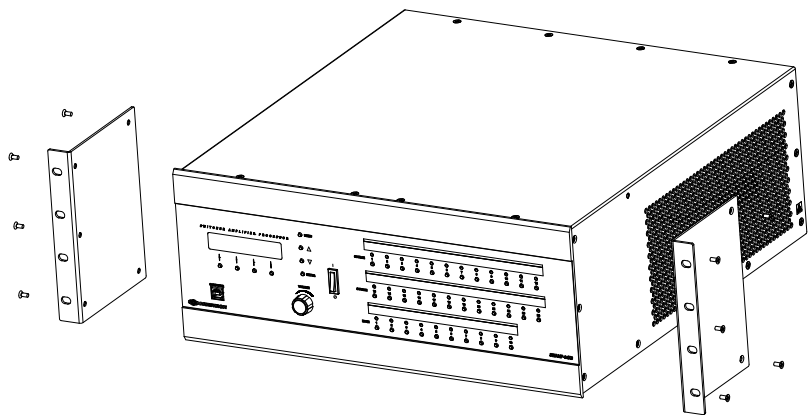

4. Repeat procedure (steps 1 through 3) to attach the remaining ear to the opposite side.

***Stacking***

Four “feet” are preinstalled with the SWAMP-24X8 so that if the unit is not rack mounted, the feet can provide stability when the unit is placed on a flat surface or stacked.

**NOTE:** No more than two SWAMP-24X8 units should be stacked.

## Hardware Hookup

### Connect the Device

Make the necessary connections as called out in the illustration that follows this paragraph. Refer to “Network Wiring” and “Sonnex Link Wiring” on page 17 for additional information. Apply power after all connections have been made.

### Hardware Connections for the SWAMP-24X8

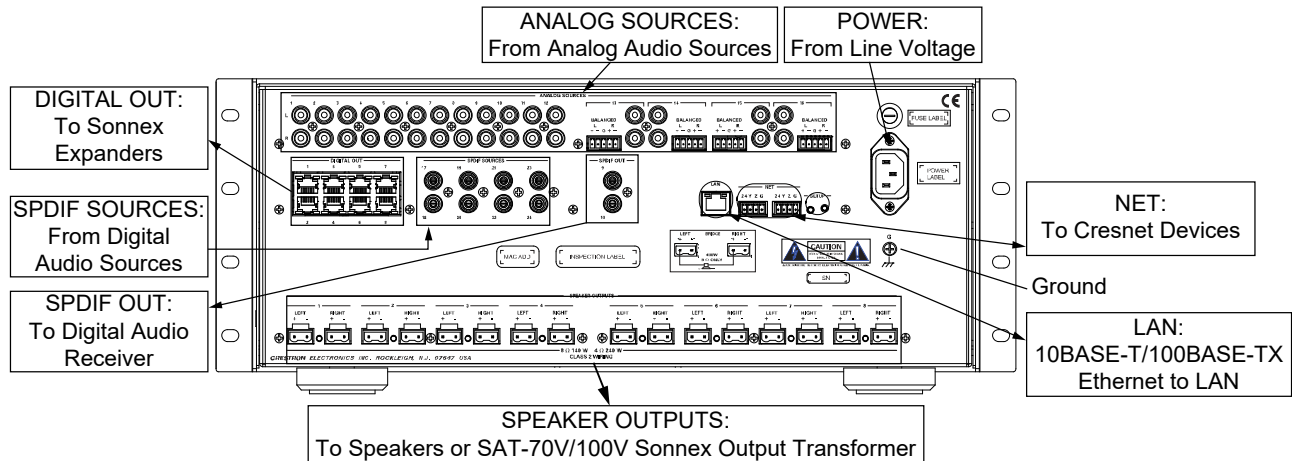

**CAUTION:** Keep the device unplugged until all of the input, network, and speaker wiring is complete.

**CAUTION:** Check the speaker wires for shorts and frayed wiring around the **SPEAKER OUTPUTS** connectors.

**NOTE:** Ensure the unit is properly grounded by connecting the chassis ground lug to an earth ground (building steel).

**NOTE:** To prevent overheating, do not operate this product in an area that exceeds the environmental temperature range listed in the table of specifications.

Four balanced/unbalanced audio inputs are provided, utilizing five-pin terminal block connectors. For connection details, refer to the following table and diagrams.

### Audio Connections

SIGNAL NAME	BALANCED AUDIO INPUT	UNBALANCED AUDIO INPUT
L +	Source L +	Source L +
L -	Source L -	Source L - jumper to GND
G	Shield/Ground	Ground
R +	Source R +	Source R +
R -	Source R -	Source - jumper to GND

*Typical Balanced/Unbalanced Inputs*

Balanced Input

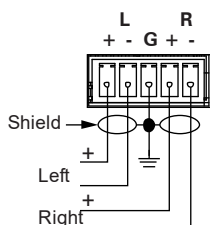

Unbalanced Input

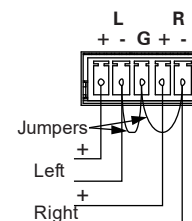

**CH Device Connections**

Devices with a RJ-45 CH output such as the CEN-IDOCV can be connected to the balanced inputs on the SWAMP-24X8 as shown in the following table.

*CH Output to SWAMP-24X8 Balanced Input*

PIN	WIRE COLORS (568B)	AUDIO I/O	BALANCED INPUT CONNECTION
1	WHITE/ORANGE	+ Audio Left Out	L +
2	ORANGE	- Audio Left Out	L -
3	WHITE/GREEN	+ Audio Right Out	R +
4	BLUE	N/A	
5	WHITE/BLUE	N/A	
6	GREEN	- Audio Right Out	R -
7	WHITE/BROWN	N/A	
8	BROWN	N/A	

**Speaker Connections**

Make speaker connections to the SWAMP-24X8 as shown in the following diagram.

*Speaker Connections*

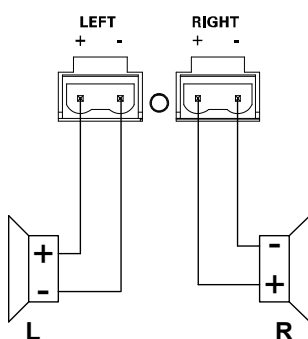

**NOTE:** If the SAT-70V/100V Sonnex Output Transformer is connected to a speaker terminal, use the SAT-70V/100V profile built into the Sonnex Tools application to configure a high-pass filter on the zone that is connected to the SAT-70V/100V. For details, refer to the Sonnex Tools help file.

**Bridge Speaker Outputs**  
(Optional)

The speaker outputs on the SWAMP-24X8 can be bridged to deliver higher power to a speaker. The left channel on an individual output can be bridged with the right channel on the same output. Refer to the following diagram when bridging outputs.

**Bridging Outputs**

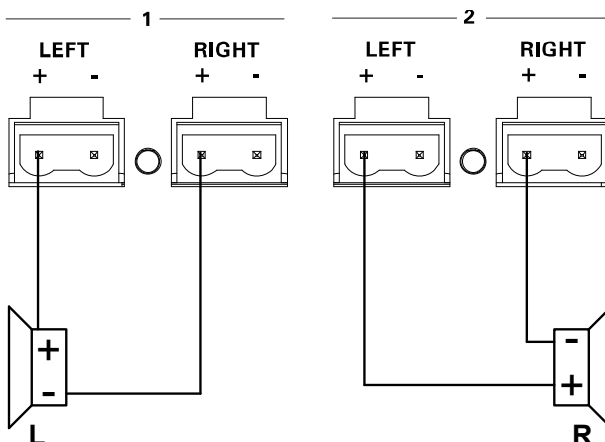

The possible bridging combinations are Zone 1 + Zone 2, Zone 3 + Zone 4, Zone 5 + Zone 6, and Zone 7 + Zone 8. LEDs on the back of the SWAMP-24X8 indicate bridged outputs.

After the zones are wired for bridged operation, the SWAMP-24X8 must be configured with the “Installer Mode” menu or with the Sonnex Tools application. Refer to “Bridge Outputs” on page 33 or the Sonnex Tools help file for more information.

---

**WARNING:** This amplifier is capable of delivering immense amounts of undistorted power to the loudspeakers. Please use caution and adequate ear protection if listening to content at high volume levels as continued exposure to high sound pressure levels can cause permanent hearing impairment or loss.

---

**Subwoofer Applications**  
(Optional)

Using a sound level (SPL) meter and Sonnex Tools, the SWAMP-24X8 can be used to deliver sound to a left-right stereo pair/subwoofer speaker layout. There are two different wiring configurations that can be used.

**Wiring Diagram: Passive Subwoofer Using an Additional Output Pair**

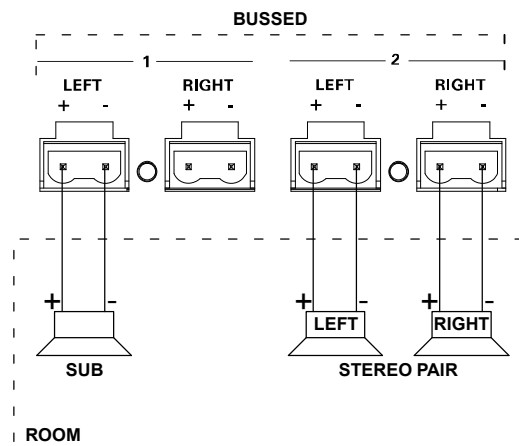

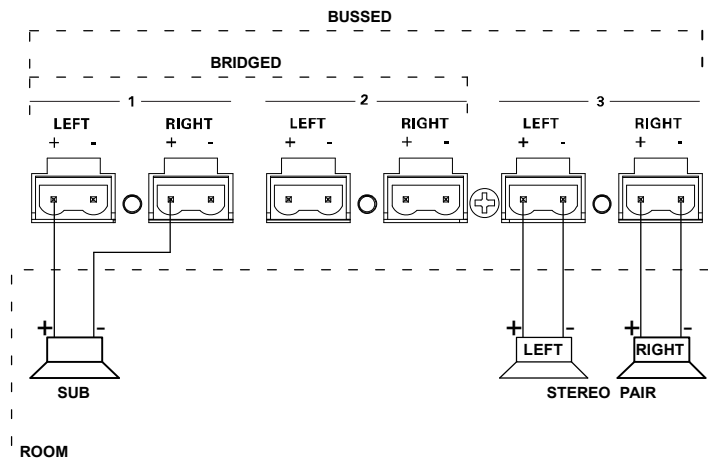
*Wiring Diagram: Passive Subwoofer Using Bridged Output*

1. Connect the speakers and subwoofer as shown in one of the previous diagrams.
2. The SWAMP-24X8 can use a 2<sup>nd</sup> or 4<sup>th</sup> order crossover filter to separate the audio signals between the subwoofer and the left-right stereo pair speakers. The 2<sup>nd</sup> order filters have a 40 dB/decade (or 12 dB/octave) slope, while the 4<sup>th</sup> order filters have an 80 dB/decade (or 24 dB/octave) slope.

Use Sonnex Tools' parametric equalizer to configure a 2<sup>nd</sup> or 4<sup>th</sup> order crossover filter. For more information, refer to the Sonnex Tools help file.

- Use a 2<sup>nd</sup> order crossover filter:
  - a. Create a low pass filter on the subwoofer zone.
    - i. Set the filter frequency to the desired crossover frequency.
    - ii. Set the filter bandwidth to 1.9.
  - b. Create a high pass filter on the left-right stereo pair zone.
    - i. Set the filter frequency to the desired crossover frequency.
    - ii. Set the filter bandwidth to 1.9.
- Use a 4<sup>th</sup> order crossover filter:
  - a. Create two low pass filters on the subwoofer zone.
    - i. Set both filters to the same crossover frequency.
    - ii. Set each filter's bandwidth to 1.9.
  - b. Create two high pass filters on the left-right stereo pair zone.
    - i. Set both filters to the same crossover frequency.
    - ii. Set each filter's bandwidth to 1.9.
- 3. Use Sonnex Tools or the SWAMP-24X8's "Installer Mode" menu to bus the outputs together. If using a bridged subwoofer, use Sonnex Tools or the SWAMP-24X8's "Installer Mode" menu to bridge the subwoofer outputs.

For more information, refer to "Set Bus Assignment" on page 31, "Bridge Outputs" which starts on page 33, or the Sonnex Tools help file.

4. Use Sonnex Tools or the SWAMP-24X8's "Installer Mode" menu to set the subwoofer output to *Mono*.

For more information, refer to "Set Mono/Stereo" on page 30 or the Sonnex Tools help file.

5. Trim the subwoofer level using an SPL meter, the pink noise files (*satellite pink noise.wav* and *subwoofer pink noise.wav*) found in the Sonnex Tools help file, and Sonnex tools.

---

**NOTE:** The audio output of the PC used to configure the system should be connected to an input on the SWAMP-24X8. The input should be routed to the connected outputs. For information on routing signals, refer to "Operation" on page 44.

---

- a. Set the SPL meter to *C-Weighted, Slow Response*.
- b. Place the SPL meter at the listening position with the meter pointing straight up.
- c. Play *satellite pink noise.wav* on the left speaker.
- d. Turn the volume up until the SPL meter reads 85 dB.
- e. Play *satellite pink noise .wav* on the right speaker. The SPL meter should read very close to 85 dB.
- f. Play *subwoofer pink noise.wav* on the left speaker.
- g. Use Sonnex Tools or the "Installer Mode" menu to adjust the bus volume offset of the subwoofer zone until the SPL meter reads 85 dB. For more information, refer to the Sonnex Tools help file or "Set Bus Volume Offset" on page 32.

### Connect to Expanders

The SWAMP-24X8 can be connected to an expander via shielded CAT5e cable to increase the number of output zones, with a maximum of eight devices.

#### SWAMP-24X8 to SWAMPE Connection (SWAMPE-8 shown)

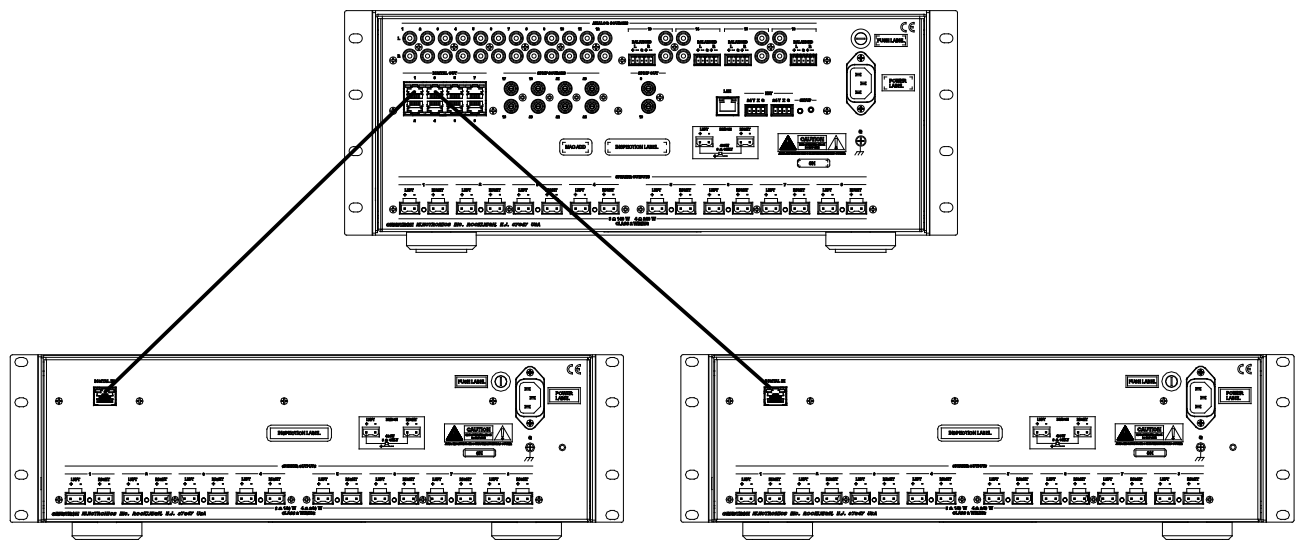

---

**NOTE:** When connecting a SWAMP-24X8 to an expander, Crestron recommends using Crestron DM-CBL-8G or high-quality CAT5e shielded twisted-pair cable. Shielded connectors such as the DM-8G-CONN must be used.

**NOTE:** If using Cresnet for communications between the SWAMP-24x8 and a control system, only one expander can be connected.

**NOTE:** The maximum cable length between a SWAMP-24X8 and an expander is 200 feet (61 meters). If additional length is needed, the S-EXT1-S can extend the Sonnex link up to 2000 feet (610 meters) over one multimode fiber strand.

### **Fuse Replacement**

If the SWAMP-24X8 does not power up when it is plugged into an AC outlet, the fuse may need to be replaced. The fuse holder is located on the rear panel, above the IEC socket assembly. To replace the fuse, perform the following procedure:

1. Disconnect power to the SWAMP-24X8.
2. Use a flat head screwdriver to push in the fuse holder.
3. While pushing in the fuse holder, turn screwdriver counterclockwise until the fuse holder pops out.
4. Remove the fuse from the fuse holder and insert a new fuse.

**CAUTION:** Use only the specified type of fuse. Failure to do so may cause damage to the SWAMP-24X8.

**NOTE:** Two spare fuses are included.

<b>SWAMP-24X8 MODEL</b>	<b>REQUIRED FUSE TYPE</b>
SWAMP-24X8 (US and Canada)	T15AH (1/4" x 1-1/4", 250 V, 15 A, time-lag, high-rupture rated)
SWAMP(I)-24X8 (International/220-240 VAC)	T8AH (5 mm x 20 mm, 250 V, 8 A, time-lag, high-rupture rated)

5. Insert the fuse holder into the SWAMP-24X8.
6. Push in the fuse holder with a flat head screwdriver. While pushing in the fuse holder, turn the screwdriver clockwise until the fuse holder sets into place.
7. Push in the fuse holder a little further and turn the screwdriver clockwise until the fuse holder locks in place.
8. Connect power to the SWAMP-24X8.

### **Label the Buttons**

Use Crestron Engraver software to print custom labels for the SWAMP-24X8's front panel buttons and LEDs. Crestron recommends printing on 100-pound paper. Paper weighing less than 100 pounds tends to crumple while sliding in, while paper weighing more than 100 pounds may not fit.

---

## Configuration

After making all hardware connections, the SWAMP-24X8 must be configured for operation. The SWAMP-24X8 can be configured from the SWAMP-24X8's front panel using the "Installer Mode" menu or from a PC using the Sonnex Tools application in Crestron Toolbox. This document contains instructions for using the "Installer Mode" menu. For information on using Sonnex Tools to configure the SWAMP-24X8, refer to the Sonnex Tools help file.

### Power

Turn on the SWAMP-24X8 by moving the **POWER** switch to |. To turn off the SWAMP-24X8, move the **POWER** switch to ∩.

### Enter the "Installer Mode" Menu

To enter the "Installer Mode" menu, press and hold ▼ and ▲ for approximately 5 seconds. The "Installer Mode" menu is displayed.

#### "Installer Mode" Menu

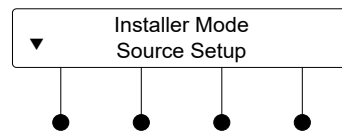

The "Installer Mode" menu is separated into seven menus:

- *Source Setup* adjusts the compensation level for each of the input sources.
- *Zone Setup* configures each output zone's settings for audio, Sonnex links (busses), bridging (with other outputs), and power output.
- *Expander Status* provides the status of each connected SWAMPE Sonnex Multiroom Audio Expander.
- *Amplifier Status* shows the settings and operating status of each of the SWAMP-24X8 amplifiers as well as the amplifiers of connected SWAMPE Sonnex Multiroom Audio Expanders.
- *Network Setup* configures and views the Ethernet settings of the SWAMP-24X8.
- *Control Setup* configures the SWAMP-24X8 for use with a Crestron control system and lock/unlock the front panel controls.
- *About* displays information about the firmware.

---

**NOTE:** Changes made to any setting are only saved upon exiting the "Installer Mode" menu. For instructions on exiting the "Installer Mode" menu, refer to "Exit the "Installer Mode" Menu" below.

---

### Exit the "Installer Mode" Menu

To exit the "Installer Mode" menu, press **MENU** until the "Installer Mode" menu is displayed (refer to illustration above), release and press **MENU** again.

## Source Setup

Select this option to adjust the compensation level of each input source. To set the compensation level, perform the following procedure:

1. Enter the "Installer Mode" menu as described in "Enter the "Installer Mode" Menu" above.



2. Press **ENTER** to select *Source Setup*.
3. Press **ENTER** to select *Compensation*.
4. Press **▼** or **▲** until the input source to be adjusted is displayed.
5. Press **ENTER** to select the input source and display the *Gain* screen.

#### **Gain Screen**

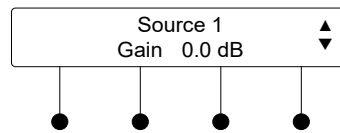

6. Press **▼** or **▲** to display the amount of gain to be applied and press **ENTER**. The display returns to the list of input sources.
7. Repeat steps 4 through 6 for each input source.
8. Press **MENU** twice to return to the “Installer Mode” menu.

## **Zone Setup**

Select this option to adjust the following parameters for each zone:

- *EQ (Equalization)* chooses an EQ setting from six preset equalization settings.
- *Bass* adjusts the bass level to the desired preference.
- *Treble* adjusts the treble level to the desired preference.
- *Loudness* applies loudness compensation to any signal routed to a zone.
- *Balance* adjusts the balance to the desired preference.
- *Mono* sets the zone for mono or stereo sound.
- *Minimum Volume* specifies the lowest volume to which the zone can be set.
- *Maximum Volume* specifies the highest volume to which the zone can be set.
- *Startup Volume* specifies the volume level that is used when a zone is turned on.
- *Bussing* assigns the selected zone to a group of zones (bus). Zones in a bus track each others' volume and source (i.e. when the source or volume for one zone in the bus is adjusted, the other zones in that bus follow).
- *Bus Volume Offset* specifies a volume offset between -12 and +12 dB that is applied on top of the volume setting for the selected zone when it is a member of a bus. Since zone volumes track in a bus this ensures the selected zone is always at the specified level above/below the other zones in the bus.
- *Bussing Lists* displays the zones that are currently members of a bus.
- *Bridging* selects output zones to be bridged.
- *Wattage* specifies the wattage rating for a speaker that is connected to a selected zone. This value is used by the Speaker Protect algorithm. When enabled, the Speaker Protect function prevents the delivered power from exceeding the speaker's power rating.

- *Impedance* specifies the impedance of a speaker connected to a selected zone.
- *Speaker Protect* enables or disables the Speaker Protect function.

---

**NOTE:** As speaker ratings vary greatly across manufacturers, there is no guarantee that Sonnex Speaker Protect protects against speaker damage in all situations.

---

- *Crestron DRC* enables or disables the Crestron Dynamic Range Control function.
- *Global EQ* sets the same EQ preset for all zones in the system. Setting this option overrides any EQ selection that was previously set for an individual zone.

#### Enter/Exit the “Zone Setup” Menu

To enter the “Zone Setup” menu, perform the following procedure:

1. Enter the “Installer Mode” menu as described in “Enter the “Installer Mode” Menu” on page 26.
2. Enter the “Installer Mode” menu as described in “Enter the “Installer Mode” Menu” on page 26.
3. Press ▼ or ▲ to display *Zone Setup* and press **ENTER**.
4. To exit the “Zone Setup” menu and return to the “Installer Mode” menu, press **MENU**.

#### Set EQ (Equalization)

To adjust a zone’s EQ setting, perform the following procedure:

1. Enter the “Zone Setup” menu as described in “Enter/Exit the “Zone Setup” Menu” above.
2. Press **ENTER** to select *EQ*.
3. Press ▼ or ▲ to display the zone to be controlled and press **ENTER**. The *EQ* screen is displayed.

##### *EQ Screen*

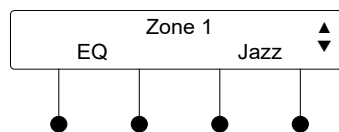

4. Press ▼ or ▲ to display the setting to be applied and press **ENTER**.
5. Repeat for every zone to be adjusted.
6. Press **MENU** to return to the “Zone Setup” menu.

#### Set Bass

To adjust a zone’s bass setting, perform the following procedure:

1. Enter the “Zone Setup” menu as described in “Enter/Exit the “Zone Setup” Menu” above.
2. Press ▼ or ▲ to display *Bass* and press **ENTER**. A list of zones is displayed.
3. Press ▼ or ▲ to display the zone to be controlled and press **ENTER**. The *Bass* screen is displayed.

**Bass Screen**

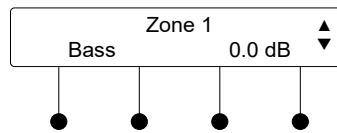

4. Press ▼ or ▲ to display the bass setting to be applied and press **ENTER**.
5. Repeat for every zone to be adjusted.
6. Press **MENU** to return to the “Zone Setup” menu.

**Set Treble**

To adjust a zone’s treble setting, perform the following procedure:

1. Enter the “Zone Setup” menu as described in “Enter/Exit the “Zone Setup” Menu” on page 28.
2. Press ▼ or ▲ to display *Treble* and press **ENTER**. A list of zones is displayed.
3. Press ▼ or ▲ to display the zone to be controlled and press **ENTER**. The *Treble* screen is displayed.

**Treble Screen**

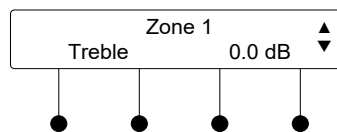

4. Press ▼ or ▲ to display the treble setting to be applied and press **ENTER**.
5. Repeat for every zone to be adjusted.
6. Press **MENU** to return to the “Zone Setup” menu.

**Set Loudness**

To adjust a zone’s loudness setting, perform the following procedure:

1. Enter the “Zone Setup” menu as described in “Enter/Exit the “Zone Setup” Menu” on page 28.
2. Press ▼ or ▲ to display *Loudness* and press **ENTER**. A list of zones is displayed.
3. Press ▼ or ▲ to display the zone to be controlled and press **ENTER**. The *Loudness* screen is displayed.

**Loudness Screen**

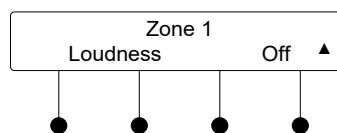

4. Press ▼ or ▲ to display the loudness setting to be applied and press **ENTER**.
5. Repeat for every zone to be adjusted.
6. Press **MENU** to return to the “Zone Setup” menu.

**Set Balance**

To adjust a zone’s balance setting, perform the following procedure:

1. Enter the “Zone Setup” menu as described in “Enter/Exit the “Zone Setup” Menu” on page 28.

- Press ▼ or ▲ to display *Balance* and press **ENTER**. A list of zones is displayed.
- Press ▼ or ▲ to display the zone to be controlled and press **ENTER**. The *Balance* screen is displayed.

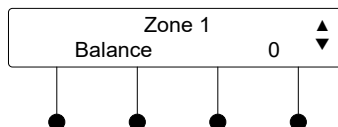
**Balance Screen**

- Press ▼ or ▲ to display the balance setting to be applied and press **ENTER**.
- Repeat for every zone to be adjusted.
- Press **MENU** to return to the “Zone Setup” menu.

**Set Mono/Stereo**

To adjust a zone’s mono/stereo setting, perform the following procedure:

- Enter the “Zone Setup” menu as described in “Enter/Exit the “Zone Setup” Menu” on page 28.
- Press ▼ or ▲ to display *Mono* and press **ENTER**. A list of zones is displayed.
- Press ▼ or ▲ to display the zone to be controlled and press **ENTER**. The *Mono/Stereo* screen is displayed.

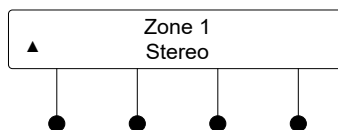
**Mono/Stereo Screen**

- Press ▼ or ▲ to display the mono/stereo setting to be applied and press **ENTER**.
- Repeat for every zone to be adjusted.
- Press **MENU** to return to the “Zone Setup” menu.

**Set Minimum Volume**

To adjust a zone’s minimum volume setting, perform the following procedure:

- Enter the “Zone Setup” menu as described in “Enter/Exit the “Zone Setup” Menu” on page 28.
- Press ▼ or ▲ to display *Minimum Volume* and press **ENTER**. A list of zones is displayed.
- Press ▼ or ▲ to display the zone to be controlled and press **ENTER**. The *Min Vol* screen is displayed.

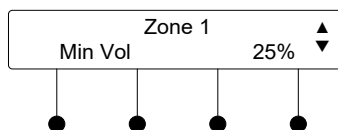
**Min Vol Screen**

- Press ▼ or ▲ to display the minimum volume setting to be applied and press **ENTER**.

5. Repeat for every zone to be adjusted.
6. Press **MENU** to return to the “Zone Setup” menu.

**Set Maximum Volume**

To adjust a zone’s maximum volume setting, perform the following procedure:

1. Enter the “Zone Setup” menu as described in “Enter/Exit the “Zone Setup” Menu” on page 28.
2. Press ▼ or ▲ to display *Maximum Volume* and press **ENTER**. A list of zones is displayed.
3. Press ▼ or ▲ to display the zone to be controlled and press **ENTER**. The *Max Vol* screen is displayed.

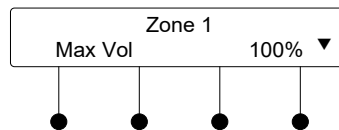
**Max Vol Screen**

4. Press ▼ or ▲ to display the maximum volume setting to be applied and press **ENTER**.
5. Repeat for every zone to be adjusted.
6. Press **MENU** to return to the “Zone Setup” menu.

**Set Startup Volume**

To adjust a zone’s startup volume setting, perform the following procedure:

1. Enter the “Zone Setup” menu as described in “Enter/Exit the “Zone Setup” Menu” on page 28.
2. Press ▼ or ▲ to display *Startup Volume* and press **ENTER**. A list of zones is displayed.
3. Press ▼ or ▲ to display the zone to be controlled and press **ENTER**. The *Startup Vol* screen is displayed.

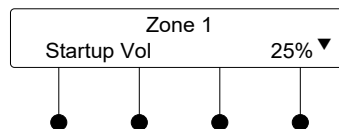
**Startup Vol Screen**

4. Press ▼ or ▲ to display the startup volume setting to be applied and press **ENTER**.
5. Repeat for every zone to be adjusted.
6. Press **MENU** to return to the “Zone Setup” menu.

**Set Bus Assignment**

To assign a zone to a bus of zones, perform the following procedure:

1. Enter the “Zone Setup” menu as described in “Enter/Exit the “Zone Setup” Menu” on page 28.
2. Press ▼ or ▲ to display *Bussing* and press **ENTER**. A list of zones is displayed.
3. Press ▼ or ▲ to display the zone to be controlled and press **ENTER**. The *Bus* screen is displayed.

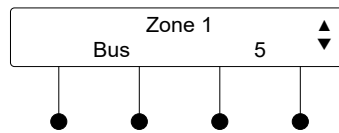
**Bus Screen**

4. Press ▼ or ▲ to display the bus to which the zone is to be assigned and press **ENTER**.
5. Repeat for every zone to be assigned.
6. Press **MENU** to return to the “Zone Setup” menu.

**Set Bus Volume Offset**

To adjust a zone’s bus volume offset setting, perform the following procedure:

1. Enter the “Zone Setup” menu as described in “Enter/Exit the “Zone Setup” Menu” on page 28.
2. Press ▼ or ▲ to display *Bus Volume Offset* and press **ENTER**. A list of zones is displayed.
3. Press ▼ or ▲ to display the zone to be controlled and press **ENTER**. The *Offset* Screen is displayed.

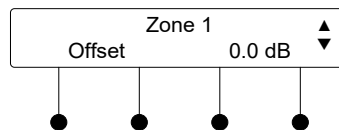
**Offset Screen**

4. Press the ▼ or ▲ buttons to display the bus volume offset setting to be applied and press **ENTER**.
5. Repeat for every zone to be adjusted.
6. Press **MENU** to return to the “Zone Setup” menu.

**View Bussing Lists**

To view the zones assigned to a bus, perform the following procedure:

1. Enter the “Zone Setup” menu as described in “Enter/Exit the “Zone Setup” Menu” on page 28.
2. Press ▼ or ▲ to display *Bussing Lists* and press **ENTER**. A list of busses is displayed.
3. Press ▼ or ▲ to display the bus to view and press **ENTER**. The first zone in the bus is displayed.

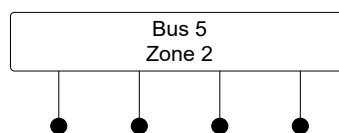
**Bus Display Screen**

4. Press ▼ or ▲ to display the other zones contained in the bus.
5. Press **ENTER** to return to the list of busses.
6. Repeat for every bus to be viewed.
7. Press **MENU** to return to the “Zone Setup” menu.

**Bridge Outputs**

To bridge outputs together, perform the following procedure:

1. Enter the “Zone Setup” menu as described in “Enter/Exit the “Zone Setup” Menu” on page 28.
2. Press ▼ or ▲ to display *Bridging* and press **ENTER**. A list of zones is displayed.
3. Press ▼ or ▲ to display the zone to be configured and press **ENTER**. The *Bridging* screen is displayed.

---

**NOTE:** Since only odd-numbered zones can be bridged with their respective, adjacent, even-numbered zones, only odd-numbered zones are listed. Refer to “Bridge Speaker Outputs” on page 22 for details.

---

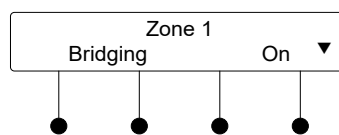
**Bridging Screen**

4. Press ▼ or ▲ to display the desired bridging setting and press **ENTER**.

---

**NOTE:** Bridged outputs are indicated with LEDs near the speaker terminals on the rear of the SWAMP-24X8 and SWAMPE Multiroom Audio Expander.

---

5. Repeat for every zone to be bridged/unbridged.
6. Press **MENU** to return to the “Zone Setup” menu.

**Set Speaker Wattage Rating**

To specify the wattage of speakers connected to a zone output, perform the following procedure:

1. Enter the “Zone Setup” menu as described in “Enter/Exit the “Zone Setup” Menu” on page 28.
2. Press ▼ or ▲ to display *Wattage* and press **ENTER**. A list of zones is displayed.
3. Press ▼ or ▲ to display the zone to be configured and press **ENTER**. The *Wattage* screen is displayed.

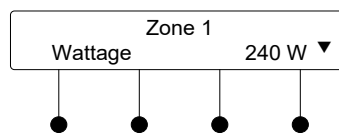
**Wattage Screen**

4. Press ▼ or ▲ to display the speaker’s wattage rating and press **ENTER**.

---

**NOTE:** If the speaker rating is not displayed, select the next-lowest rating to avoid damage to the connected speakers.

---

5. Repeat for every zone to be configured.
6. Press **MENU** to return to the “Zone Setup” menu.

**Set Speaker Impedance**

To specify the impedance of speakers connected to a zone output, perform the following procedure:

1. Enter the “Zone Setup” menu as described in “Enter/Exit the “Zone Setup” Menu” on page 28.
2. Press ▼ or ▲ to display *Impedance* and press **ENTER**. A list of zones is displayed.
3. Press ▼ or ▲ to display the zone to be configured and press **ENTER**. The *Impedance* screen is displayed.

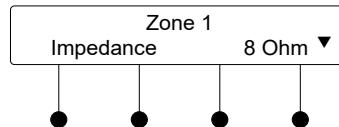
**Impedance Screen**

4. Press ▼ or ▲ to display the speaker’s impedance rating and press **ENTER**.
5. Repeat for every zone to be configured.
6. Press **MENU** to return to the “Zone Setup” menu.

**Set Speaker Protection**

To enable/disable speaker protection for a zone output, perform the following procedure:

---

**NOTE:** As speaker ratings vary greatly across manufacturers, there is no guarantee that Sonnex Speaker Protect protects against speaker damage in all situations.

---

1. Enter the “Zone Setup” menu as described in “Enter/Exit the “Zone Setup” Menu” on page 28.
2. Press ▼ or ▲ to display *Speaker Protect* and press **ENTER**. A list of zones is displayed.
3. Press ▼ or ▲ to display the zone to be configured and press **ENTER**. The *Protect* screen is displayed.

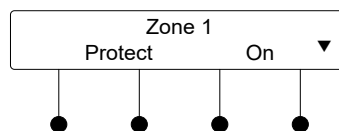
**Protect Screen**

4. Press ▼ or ▲ to display the desired speaker protection setting and press **ENTER**.
5. Repeat for every zone to be configured.
6. Press **MENU** to return to the “Zone Setup” menu.

**Set Crestron Dynamic Range Control (DRC)**

To enable/disable DRC for a zone output, perform the following procedure:

1. Enter the “Zone Setup” menu as described in “Enter/Exit the “Zone Setup” Menu” on page 28.
2. Press ▼ or ▲ to display *Crestron DRC* and press **ENTER**. A list of zones is displayed.
3. Press ▼ or ▲ to display the zone to be configured and press **ENTER**. The *Crestron DRC* screen is displayed.

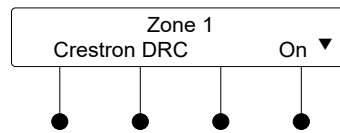

*Crestron DRC Screen*

4. Press ▼ or ▲ to display the desired DRC setting and press **ENTER**.
5. Repeat for every zone to be configured.
6. Press **MENU** to return to the “Zone Setup” menu.

**Set Global EQ**

To adjust a global EQ setting, perform the following procedure:

---

**NOTE:** Adjusting a global EQ setting overrides the individual EQ settings for all zones.

---

1. Enter the “Zone Setup” menu as described in “Enter/Exit the “Zone Setup” Menu” on page 28.
2. Press ▼ or ▲ to display *Global EQ* and press **ENTER**. A list of Global EQ settings is displayed.
3. Press ▼ or ▲ to display the desired setting and press **ENTER**.

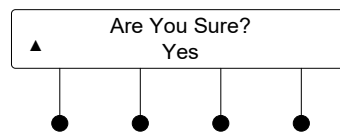
*Confirm Global EQ Setting Screen*

4. Press ▼ or ▲ to display *Yes* or *No* and press **ENTER**. The display returns to the “Zone Setup” menu.

**Expander Status**

Select this option to view the status and information about devices that are connected to the SWAMP-24X8. To view information, perform the following procedure:

1. Enter the “Installer Mode” menu as described in “Enter the “Installer Mode” Menu” on page 26.
2. Press ▼ or ▲ to display *Expander Status* and press **ENTER**. The “Expander Status” menu is displayed.
3. Press ▼ or ▲ to display the expander to view and press **ENTER**.
4. Press ▼ or ▲ to view available information.
5. Press **ENTER** to return to the list of expanders.
6. To exit and return to the “Installer Mode” menu, press **MENU**.

## Amplifier Status

Select this option to view the settings and operating status of each of the SWAMP-24X8 amplifiers as well as the amplifiers of connected expanders. To view information about the amplifier, perform the following procedure:

1. Enter the “Installer Mode” menu as described in “Enter the “Installer Mode” Menu” on page 26.
2. Press ▼ or ▲ to display *Amplifier Status* and press **ENTER**. The “Amplifier Status” menu is displayed.

A list of amplifier faults or view information about a specific zone can be viewed from the “Amplifier Status” menu.

### View Amplifier Faults

To view a list of amplifier faults in all of the zones, perform the following procedure:

1. Press ▼ or ▲ to display *Faults* and press **ENTER**.
2. Press ▼ or ▲ to scroll through the list of amplifier faults.
3. Press **MENU** to return to the “Amplifier Status” menu.
4. Press **MENU** to return to the “Installer Mode” menu.

### View Zones

To view information for a specific zone, perform the following procedure:

1. Press ▼ or ▲ to display the desired zone and press **ENTER**.
2. Press ▼ or ▲ to scroll through the available information.
3. Press **MENU** to return to the “Amplifier Status” menu.
4. Press **MENU** to return to the “Installer Mode” menu.

## Network Setup

Select this option to configure and view the SWAMP-24X8 network settings.

### Enter/Exit the “Network Setup” Menu

To enter the “Network Setup” menu, perform the following procedure:

1. Enter the “Installer Mode” menu as described in “Enter the “Installer Mode” Menu” on page 26.
2. Press ▼ or ▲ to display *Network Setup* and press **ENTER**.
3. To exit the “Network Setup” menu and return to the “Installer Mode” menu, press **MENU**.

### Set the IP Address

The SWAMP-24X8 can use TCP/IP for communication between a control system and a SWAMP-24X8. The IP address can be manually set or obtained from a DHCP server. For information on enabling DHCP to obtain an IP address, refer to “Enable/Disable DHCP” on page 38. To view or manually set an IP address, perform the following procedure:

1. Enter the “Network Setup” menu as described on page 36.
2. Press ▼ or ▲ to display *IP Address* and press **ENTER**. The “IP Address” screen is displayed.

#### “IP Address” Screen

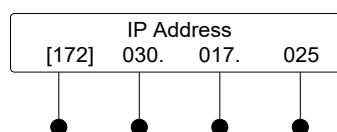

3. Press ▼ or ▲ to set the first octet of the IP address.
4. Press the button under the next octet (or press **ENTER** to move to the next octet) to select it for editing.
5. Repeat steps 3 and 4 for each octet.
6. To save the IP address and return to the “Network Setup” menu, move the cursor to the right-most octet and press **ENTER**. To cancel the operation and return to the previous screen, press **MENU**.

### Set the Subnet Mask

The subnet mask can be manually set or obtained from a DHCP server. For information on enabling DHCP to obtain a subnet mask, refer to “Enable/Disable DHCP” on page 38. To view or manually set the subnet mask, perform the following procedure:

1. Enter the “Network Setup” menu as described on page 36.
2. Press ▼ or ▲ to display *Subnet Mask* and press **ENTER**. The “Subnet Mask” screen is displayed.

#### “Subnet Mask” Screen

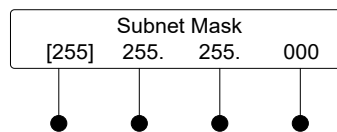

3. Press ▼ or ▲ to set the first octet of the subnet mask.
4. Press the button under the next octet (or press **ENTER** to move to the next octet) to select it for editing.
5. Repeat steps 3 and 4 for each octet.
6. To save the subnet mask and return to the “Network Setup” menu, move the cursor to the right-most octet and press **ENTER**. To cancel the operation and return to the previous screen, press **MENU**.

### Set the Default Router

The default router can be manually set or obtained from a DHCP server. For information on enabling DHCP to obtain a default router, refer to “Enable/Disable DHCP” on page 38. To view or manually set the default router, perform the following procedure:

1. Enter the “Network Setup” menu as described on page 36.
2. Press ▼ or ▲ to display *Default Router* and press **ENTER**. The “Default Router” screen is displayed.

#### “Default Router” Screen

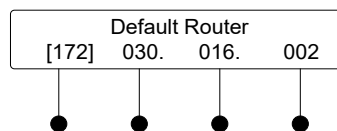

3. Press ▼ or ▲ to set the first octet of the default router.
4. Press the button under the next octet (or press **ENTER** to move to the next octet) to select it for editing.
5. Repeat steps 3 and 4 for each octet.

- To save the default router and return to the “Network Setup” menu, move the cursor to the right-most octet and press **ENTER**. To cancel the operation and return to the previous screen, press **MENU**.

**Enable/Disable DHCP**

The SWAMP-24X8 can obtain an IP address, subnet mask, and default router information from a DHCP server. To enable or disable DHCP, perform the following procedure:

- Enter the “Network Setup” menu as described on page 36.
- Press **▼** or **▲** to display *DHCP* and press **ENTER**. The “DHCP” screen is displayed.

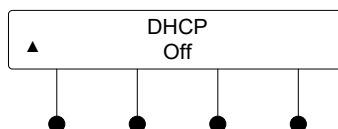
**“DHCP” Screen**

- Press **▼** or **▲** to display the desired setting and press **ENTER**. The display returns to the previous screen.

**Enable/Disable WINS**

The SWAMP-24X8 can be configured to use a WINS server for communication. To enable or disable WINS, perform the following procedure:

- Enter the “Network Setup” menu as described on page 36.
- Press **▼** or **▲** to display *WINS* and press **ENTER**. The “WINS” screen is displayed.

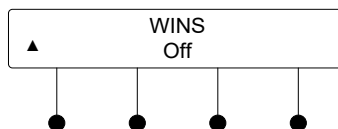
**“WINS” Screen**

- Press **▼** or **▲** to display the desired setting and press **ENTER**. The display returns to the previous screen.

**Display MAC Address**

To display the MAC address, perform the following procedure:

- Enter the “Network Setup” menu as described on page 36.
- Press **▼** or **▲** to display *MAC Address* and press **ENTER**. The MAC address is displayed.
- Press **ENTER** to return to the previous screen.

**Display Hostname**

To display the hostname, perform the following procedure:

- Enter the “Network Setup” menu as described on page 36.
- Press **▼** or **▲** to display *Hostname* and press **ENTER**. The hostname is displayed.
- Press **ENTER** to return to the previous screen.

---

**NOTE:** The hostname can be changed with Crestron Toolbox.

---

**Display Domain Name**

To display the domain name, perform the following procedure:

- Enter the “Network Setup” menu as described on page 36.

2. Press ▼ or ▲ to display *Domain Name* and press **ENTER**. The domain name is displayed.
3. Press **ENTER** to return to the previous screen.

---

**NOTE:** The domain name can be changed with Crestron Toolbox.

---

## Control Setup

Select this option to configure and view the SWAMP-24X8 control system settings.

### Enter/Exit the “Control Setup” Menu

To enter the “Control Setup” menu, perform the following procedure:

1. Enter the “Installer Mode” menu as described in “Enter the “Installer Mode” Menu” on page 26.
2. Press ▼ or ▲ to display *Control Setup* and press **ENTER**.
3. To exit the “Control Setup” menu and return to the “Installer Mode” menu, press **MENU**.

### Lock Front Panel

The front panel controls of the SWAMP-24X8 can be locked to prevent unauthorized access. To lock or unlock the front panel, perform the following procedure:

1. Enter the “Control Setup” menu as described above.
2. Press ▼ or ▲ to display *Front Panel Lock* and press **ENTER**. The “Front Panel Lock” screen is displayed.

#### “Front Panel Lock” Screen

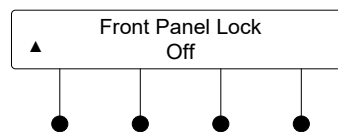

3. Press ▼ or ▲ to display the desired setting and press **ENTER**. The display returns to the previous screen.

### Set the Cresnet ID

If the SWAMP-24X8 is to communicate with a control system over Cresnet, the Net ID must be set. To set the Net ID using the front panel, perform the following procedure:

1. Enter the “Control Setup” menu as described above.
2. Press ▼ or ▲ to display *Cresnet ID* and press **ENTER**. The “Cresnet ID” screen is displayed.

#### “Cresnet ID” Screen

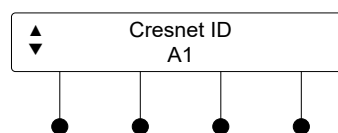

3. Press ▼ or ▲ to display the desired setting and press **ENTER**. The display returns to the previous screen.

### Set the IP ID

If the SWAMP-24X8 is to communicate with a control system over TCP/IP, the IP ID must be set. To set the IP ID using the front panel, perform the following procedure:

1. Enter the “Control Setup” menu as described on page 39.

- Press ▼ or ▲ to display *IP ID* and press **ENTER**. The “IP ID” screen is displayed.

**“IP ID” Screen**

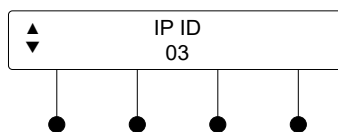

- Press ▼ or ▲ to display the desired setting and press **ENTER**. The display returns to the previous screen.

**Set the Control System IP Address**

If the SWAMP-24X8 is to communicate with a control system over TCP/IP, the control system’s IP address must be set. To set the control system’s IP address using the front panel, perform the following procedure:

- Enter the “Control Setup” menu as described on page 39.
- Press ▼ or ▲ to display *Ctrl Sys IP Addr* and press **ENTER**. The “Ctrl Sys IP Addr” screen is displayed.

**“Ctrl Sys IP Addr” Screen**

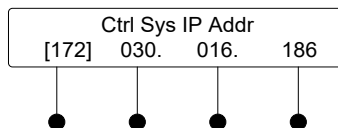

- Press ▼ or ▲ to set the first octet of the control system IP address.
- Press the button under the next octet (or press **ENTER** to move to the next octet) to select it for editing.
- Repeat steps 3 and 4 for each octet.
- To save the control system IP address and return to the “Control Setup” menu, move the cursor to the right-most octet and press **ENTER**. To cancel the operation and return to the previous screen, press **MENU**.

## About

Select this option to view information about the operating firmware in the SWAMP-24X8. To view information about the SWAMP-24X8, perform the following procedure:

- Enter the “Installer Mode” menu as described in “Enter the “Installer Mode” Menu” on page 26.
- Press ▼ or ▲ to display *About* and press **ENTER**.
- Press ▼ or ▲ to display information about the SWAMP-24X8.
- Press **ENTER** to return to the “Installer Mode” menu.

---

## Uploading and Upgrading

Crestron recommends using the latest programming software and that each device contains the latest firmware to take advantage of the most recently released features. However, before attempting to upload or upgrade it is necessary to establish communication. Once communication has been established, files (for example, programs or firmware) can be transferred to the control system (and/or device). Finally, program checks can be performed (such as changing the device ID or creating an IP table) to ensure proper functioning.

---

**NOTE:** Crestron software and any files on the website are for authorized Crestron dealers and Crestron Service Providers (CSPs) only. New users must register to obtain access to certain areas of the site (including the FTP site).

---

## Establishing Communication

Use Crestron Toolbox for communicating with the SWAMP-24X8; refer to the Crestron Toolbox help file for details. There are three methods of communication: indirect, USB, and TCP/IP.

### Indirect

#### Indirect Communication



SWAMP-24X8 connects to control system via Cresnet:

1. Click **Tools | System Info**.
2. Click the  icon.
3. For *Connection Type*, select *Indirect*.
4. For *Device is at*, select *Cresnet ID* and select the ID number from the drop-down menu.
5. In the *Through* drop-down menu, select the control system.

---

**NOTE:** If no address book entry is listed for the control system, click **Address Book...** to create an entry. For details, refer to the Crestron Toolbox help file.

---

6. Click **OK**. Communications are confirmed when the device information is displayed.

**USB**

**NOTE:** May be required for initial setup of Ethernet parameters.

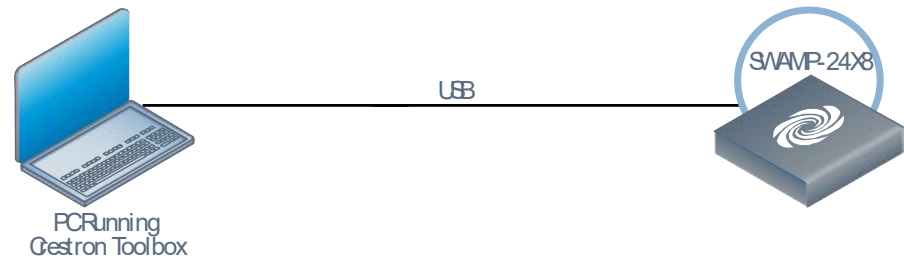
**USB Communication**

The **COMPUTER** port on the SWAMP-24X8 connects to the USB port on the PC via the included Type A to Type B USB cable:

1. Click **Tools | System Info**.
2. Click the  icon.
3. For *Connection Type*, select *USB*. When multiple USB devices are connected, identify the SWAMP-24X8 by entering “SWAMP-24X8” in the *Model* text box, the unit’s serial number in the *Serial* text box or the unit’s hostname (if known) in the *Hostname* text box.
4. Click **OK**. Communications are confirmed when the device information is displayed.

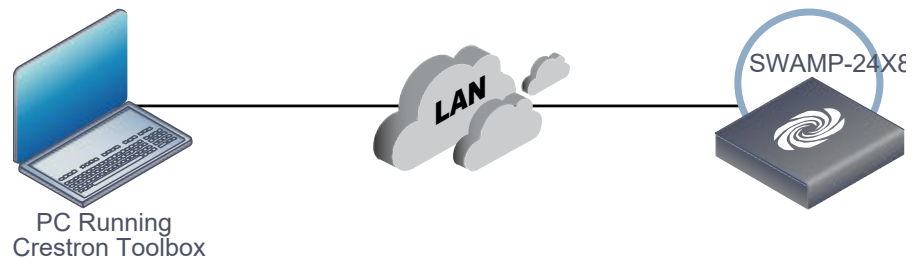
**TCP/IP****Ethernet Communication**

The SWAMP-24X8 connects to PC via Ethernet:

1. Use the Device Discovery Tool (click the  icon) in Crestron Toolbox to detect all Ethernet devices on the network and their IP configuration. The tool is available in Toolbox version 1.15.143 or later.
2. Click on the SWAMP-24X8 to display information about the device.

**Programs and Firmware**

Program or firmware files may be distributed from programmers to installers or from Crestron to dealers. Firmware upgrades are available from the Crestron website as new features are developed after product releases. One has the option to upload programs via the programming software or to upload and upgrade via the Crestron Toolbox. For details on uploading and upgrading, refer to the Crestron Studio help file, SIMPL Windows help file, or the Crestron Toolbox help file.

**Crestron Studio or SIMPL Windows**

If a Crestron Studio (or SIMPL Windows) program is provided, it can be uploaded to the control system using Crestron Studio (or SIMPL Windows) or Crestron Toolbox.



**Firmware**

Check the Crestron website to find the latest firmware. (New users must register to obtain access to certain areas of the site, including the FTP site.)

Upgrade SWAMP-24X8 firmware via Crestron Toolbox.

1. Establish communication with the SWAMP-24X8 as described in “Establishing Communication” which starts on page 41.
2. Select **Tools | Package Update Tool...** to upgrade the SWAMP-24X8 firmware or double click on an appropriate Package Update File (PUF) located on the hard drive. The Package Update Tool is loaded as a standalone application.

## Program Checks

Actions that can be performed on the SWAMP-24X8 vary depending on whether it is connected via Cresnet or Ethernet.

**Cresnet Connections**

For Cresnet connections, using Crestron Toolbox, display the network device tree (**Tools | Network Device Tree View**) to show all network devices connected to the control system. Right-click on the SWAMP-24X8 to display actions that can be performed on the SWAMP-24X8.

**Ethernet Connections**

For Ethernet connections, using Crestron Toolbox, display the “System Info” window (**Tools | System Info**) and select the **Functions** menu to display actions that can be performed on the SWAMP-24X8.

Be sure to use Crestron Toolbox to create the SWAMP-24X8 IP table.

1. Select **Functions | IP Table Setup**.
2. Add, modify or delete entries in the IP table. The SWAMP-24X8 can have only one IP table entry.
3. A defined IP table can be saved to a file or sent to the device.

Edit the control system’s IP table to include an entry for the SWAMP-24X8. The entry should list the SWAMP-24X8’s IP ID (specified on the SWAMP-24X8’s IP table) and the internal gateway IP address 127.0.0.1.

## Operation

The SWAMP-24X8 can be controlled from the front panel or the Sonnex Tool in Crestron Toolbox.

**NOTE:** For information on Crestron Toolbox, refer to the Crestron Toolbox help file.

### Power

To turn on the SWAMP-24X8, move the **POWER** switch to  $\uparrow$ . To turn off the SWAMP-24X8, move the **POWER** switch to  $\downarrow$ .

### Operating Modes

When operated from the front panel, the SWAMP-24X8 operates in either *Zone* mode or *Source* mode.

Use the “Main Menu” to select *Zone Mode* or *Source Mode*. To display the “Main Menu”, press **MENU** until *Main Menu* appears on the display.

“Main Menu”

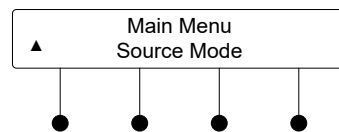

#### Zone Mode

*Zone* mode uses the front panel to route a source signal to a selected zone. To use *Zone* mode, perform the following procedure:

1. From the “Main Menu”, press  $\blacktriangledown$  or  $\blacktriangle$  to display *Zone Mode* and press **ENTER**.
2. Press the **ZONE** button of the zone to be controlled.
3. Press the **SOURCE** button of the source to be routed. The associated **SOURCE** and **ZONE** LEDs light and the display shows the zone’s selected source. Alternatively, press the **ZONE** button twice to turn on the zone and connect the source that was selected last.
4. To turn off the zone, press the **ZONE** button.
5. Press **MENU** to return to the “Main Menu”.

#### Source Mode

*Source* mode uses the front panel to select a source signal and route it to multiple zones. To use *Source* mode, perform the following procedure:

1. From the “Main Menu”, press  $\blacktriangledown$  or  $\blacktriangle$  to display *Source Mode* and press **ENTER**.
2. Press the **SOURCE** button of the source to be routed. The associated **SOURCE** LED lights.
3. Press the **ZONE** button(s) of the zone(s) to be selected. The associated **ZONE** LED(s) lights.
4. To remove a zone from a source, press the desired **ZONE** button. The associated **ZONE** LED turns off.

5. Press **MENU** to return to the “Main Menu”.

## **Volume Control**

To raise the volume in the selected zone(s), turn the **VOLUME** knob clockwise. To lower the volume in the selected zone(s), turn the **VOLUME** knob counterclockwise.

## Problem Solving

### Troubleshooting

The following table provides corrective action for possible trouble situations. If further assistance is required, please contact a Crestron customer service representative.

#### *SWAMP-24X8 Troubleshooting*

TROUBLE	POSSIBLE CAUSE(S)	CORRECTIVE ACTION
Device does not function.	Device is not communicating with the network.	Use Crestron Toolbox to poll the network. Verify network connection to the device.
Audio dropouts heard on SWAMPE zone.	Bad or no shield on Sonnex cable connecting SWAMP-24X8 and peripheral device.	Ensure continuity and integrity of shield on both ends of the Sonnex cable.
60 Hz hum heard on a selected input source.	The source has no earth ground.	Connect the chassis of the source to the <b>G</b> (Ground) screw on the SWAMP-24X8.
An incorrect audio signal is heard.	The audio signal is incorrectly routed.	Reroute the signal.
	The zone is incorrectly bussed with other zone(s).	Remove zone from bus.
Device loses functionality due to electrostatic discharge.	Device is improperly grounded.	Check that all ground connections have been made properly.

### Check Network Wiring

#### *Use the Right Wire*

To ensure optimum performance over the full range of the installation topology, use Crestron Certified Wire only. Failure to do so may incur additional charges if support is required to identify performance deficiencies because of using improper wire.

#### *Calculate Power*

**CAUTION:** Use only Crestron power supplies for Crestron equipment. Failure to do so could cause equipment damage or void the Crestron warranty.

**CAUTION:** Provide sufficient power to the system. Insufficient power can lead to unpredictable results or damage to the equipment. Use the Crestron Power Calculator to help calculate how much power is needed for the system ([www.crestron.com/calculators](http://www.crestron.com/calculators)).

When calculating the length of wire for a particular Cresnet run, the wire gauge and the Cresnet power usage of each network unit to be connected must be taken into consideration. Use Crestron Certified Wire only. If Cresnet units are to be daisy chained on the run, the Cresnet power usage of each network unit to be daisy

chained must be added together to determine the Cresnet power usage of the entire chain. If the unit is run from a Crestron system power supply network port, the Cresnet power usage of that unit is the Cresnet power usage of the entire run. The wire gauge and the Cresnet power usage of the run should be used in the following equation to calculate the cable length value on the equation's left side.

**Cable Length Equation**

$$L < \frac{40,000}{R \times P}$$

Where: L = Length of run (or chain) in feet  
 R = 6 Ohms (Crestron Certified Wire: 18 AWG (0.75 mm<sup>2</sup>))  
 or 1.6 Ohms (Cresnet HP: 12 AWG (4 mm<sup>2</sup>))  
 P = Cresnet power usage of entire run (or chain)

Make sure the cable length value is less than the value calculated on the right side of the equation. For example, a Cresnet run using 18 AWG Crestron Certified Wire and drawing 20 watts should not have a length of run more than 333 feet (101 meters). If Cresnet HP is used for the same run, its length could extend to 1250 feet (381 meters).

---

**NOTE:** All Crestron certified Cresnet wiring must consist of two twisted pairs. One twisted pair is the **24** and **G** pair and the other twisted pair is the **Y** and **Z** pair.

---

**Strip and Tin Wire**

When daisy chaining Cresnet units, strip the ends of the wires carefully to avoid nicking the conductors. Twist together the ends of the wires that share a pin on the network connector and tin the twisted connection. Apply solder only to the ends of the twisted wires. Avoid tinning too far up the wires or the end becomes brittle. Insert the tinned connection into the Cresnet connector and tighten the retaining screw. Repeat the procedure for the other three conductors.

**Add Hubs**

Use of a Cresnet Hub/Repeater (CNXHUB) is advised whenever the number of Cresnet devices on a network exceeds 20 or when the combined total length of Cresnet cable exceeds 3000 feet (914 meters).

## Reference Documents

All documents mentioned in this guide are available at [www.crestron.com/manuals](http://www.crestron.com/manuals).

*List of Related Reference Documents*

DOCUMENT TITLE
Crestron e-Control Reference Guide

## Further Inquiries

To locate specific information or resolve questions after reviewing this guide, contact Crestron's True Blue Support at 1-888-CRESTRON [1-888-273-7876] or, for assistance within a particular geographic region, refer to the listing of Crestron worldwide offices at [www.crestron.com/offices](http://www.crestron.com/offices).

To post a question about Crestron products, log onto Crestron's Online Help at [www.crestron.com/onlinehelp](http://www.crestron.com/onlinehelp). First-time users must establish a user account to fully benefit from all available features.

## Future Updates

As Crestron improves functions, adds new features, and extends the capabilities of the SWAMP-24X8, additional information may be made available as manual

updates. These updates are solely electronic and serve as intermediary supplements prior to the release of a complete technical documentation revision.

Check the Crestron website periodically for manual update availability and its relevance. Updates are identified as an “Addendum” in the Download column.

---

## Return and Warranty Policies

### Merchandise Returns / Repair Service

1. No merchandise may be returned for credit, exchange or service without prior authorization from Crestron. To obtain warranty service for Crestron products, contact an authorized Crestron dealer. Only authorized Crestron dealers may contact the factory and request an RMA (Return Merchandise Authorization) number. Enclose a note specifying the nature of the problem, name and phone number of contact person, RMA number and return address.
2. Products may be returned for credit, exchange or service with a Crestron Return Merchandise Authorization (RMA) number. Authorized returns must be shipped freight prepaid to Crestron, 6 Volvo Drive, Rockleigh, N.J. or its authorized subsidiaries, with RMA number clearly marked on the outside of all cartons. Shipments arriving freight collect or without an RMA number shall be subject to refusal. Crestron reserves the right in its sole and absolute discretion to charge a 15% restocking fee plus shipping costs on any products returned with an RMA.
3. Return freight charges following repair of items under warranty shall be paid by Crestron, shipping by standard ground carrier. In the event repairs are found to be non-warranty, return freight costs shall be paid by the purchaser.

### Crestron Limited Warranty

Crestron Electronics, Inc. warrants its products to be free from manufacturing defects in materials and workmanship under normal use for a period of three (3) years from the date of purchase from Crestron, with the following exceptions: disk drives and any other moving or rotating mechanical parts, pan/tilt heads and power supplies are covered for a period of one (1) year; touch screen display and overlay components are covered for 90 days; batteries and incandescent lamps are not covered.

This warranty extends to products purchased directly from Crestron or an authorized Crestron dealer. Purchasers should inquire of the dealer regarding the nature and extent of the dealer's warranty, if any.

Crestron shall not be liable to honor the terms of this warranty if the product has been used in any application other than that for which it was intended or if it has been subjected to misuse, accidental damage, modification or improper installation procedures. Furthermore, this warranty does not cover any product that has had the serial number altered, defaced or removed.

This warranty shall be the sole and exclusive remedy to the original purchaser. In no event shall Crestron be liable for incidental or consequential damages of any kind (property or economic damages inclusive) arising from the sale or use of this equipment. Crestron is not liable for any claim made by a third party or made by the purchaser for a third party.

Crestron shall, at its option, repair or replace any product found defective, without charge for parts or labor. Repaired or replaced equipment and parts supplied under this warranty shall be covered only by the unexpired portion of the warranty.

Except as expressly set forth in this warranty, Crestron makes no other warranties, expressed or implied, nor authorizes any other party to offer any warranty, including any implied warranties of merchantability or fitness for a particular purpose. Any implied warranties that may be imposed by law are limited to the terms of this limited warranty. This warranty statement supersedes all previous warranties.



Crestron Electronics, Inc.  
15 Volvo Drive Rockleigh, NJ 07647  
Tel: 888.CRESTRON  
Fax: 201.767.7576  
[www.crestron.com](http://www.crestron.com)



Operations Guide – DOC. 7049E  
(2028550)

06.20

Specifications subject to  
change without notice.