



HARDWARE REFERENCE MANUAL

DXLINK™ TWISTED PAIR 4K60 TRANSMITTER/RECEIVER

DX-TX-4K60, DX-RX-4K60



Important Safety Instructions

READ these instructions.

KEEP these instructions.

HEED all warnings.

FOLLOW all instructions.

DO NOT use this apparatus near water.

CLEAN ONLY with dry cloth.

DO NOT block any ventilation openings. Install in accordance with the manufacturer's instructions.

DO NOT install near any heat sources such as radiators, heat registers, stoves, or other apparatus (including amplifiers) that produce heat.

PROTECT the power cord from being walked on or pinched, particularly at plugs, convenience receptacles, and the point where they exit from the apparatus.

ONLY USE attachments/accessories specified by the manufacturer.



USE ONLY with a cart, stand, tripod, bracket, or table specified by the manufacturer, or sold with the apparatus. When a cart is used, use caution when moving the cart/apparatus combination to avoid injury from tip-over.

REFER all servicing to qualified service personnel. Servicing is required when the apparatus has been damaged in any way, such as power-supply cord or plug is damaged, liquid has been spilled or objects have fallen into the apparatus, the apparatus has been exposed to rain or moisture, does not operate normally, or has been dropped.

DO NOT EXPOSE THIS APPARATUS TO DRIPPING OR SPLASHING AND ENSURE THAT NO OBJECTS FILLED WITH LIQUIDS, SUCH AS VASES, ARE PLACED ON THIS APPARATUS.

To completely disconnect this apparatus from the AC Mains, disconnect the power supply cord plug from the AC receptacle.

Where the mains plug or an appliance coupler is used as the disconnect device, the disconnect device shall remain readily operable._

DO NOT overload wall outlets or extension cords beyond their rated capacity as this can cause electric shock or fire.

Warnings



ESD Warning: The icon to the left indicates text regarding potential danger associated with the discharge of static electricity from an outside source (such as human hands) into an integrated circuit, often resulting in damage to the circuit.

WARNING: To reduce the risk of fire or electrical shock, do not expose this apparatus to rain or moisture.

WARNING: No naked flame sources - such as candles - should be placed on the product.

WARNING: Equipment shall be connected to a MAINS socket outlet with a protective earthing connection.

WEEE Notice

The Directive on Waste Electrical and Electronic Equipment (WEEE), which entered into force as European law on 14/02/2014, resulted in a major change in the treatment of electrical equipment at end-of-life.

The purpose of this Directive is, as a first priority, the prevention of WEEE, and in addition, to promote the reuse, recycling and other forms of recovery of such wastes so as to reduce disposal. The WEEE logo on the product or on its box indicating collection for electrical and electronic equipment consists of the crossed-out wheeled bin, as shown below.



This product must not be disposed of or dumped with your other household waste. You are liable of dispose of all your electronic or electrical waste equipment by relocating over to the specified collection point for recycling of such hazardous waste. Isolated collection and proper recovery of your electronic and electrical waste equipment at the time of disposal will allow us to help conserving natural resources. Moreover, proper recycling of the electronic and electrical waste equipment will ensure safety of human health and environment. For more information about electronica and electrical waste equipment disposal, recovery, and collection points, please contact your local city center, household waste disposal service, shop from where you purchased the equipment, or manufacturer of the equipment.

RoHS Compliance

This product is in compliance with Directive 2011/65/EU and (EU) 2015/863 of the European Parliament and of the Council of 31/03/2015 on the restriction of the use of certain hazardous substances in electrical and electronic equipment.

REACH

REACH (Regulation No 1907/2006) addresses the production and use of chemical substances and their potential impacts on human health and the environment. Article 33 (1) of REACH Regulation requires suppliers to inform the recipients if an article contains more than 0.1% (per weight per article) of any substance(s) on the Substances of Very High Concern (SVHC) Candidate List ('REACH candidate list').

This product contains the substance "lead" (CAS-No. 7439-92-1) in a concentration of more than 0.1% per weight. At the time of release of this product, except for the lead substance, no other substances of REACH candidate list are contained in a concentration of more than 0.1% per weight in this product.

Note: On June 27, 2018, lead was added to the REACH candidate list. The inclusion of lead in the REACH candidate list does not mean that lead-containing materials pose an immediate risk or results in a restriction of permissibility of its use.

CAUTION FCC AND IC STATEMENT FOR USERS (USA AND CANADA ONLY)

This device complies with part 15 of the FCC Rules. Operation is subject to the following two conditions: (1) this device may not cause harmful interference, and (2) this device must accept any interference received, including interference that may cause undesired operation.

CAN ICES-3 (B)/NMB-3(B)

FCC SDOC SUPPLIER'S DECLARATION OF CONFORMITY

This equipment has been tested and found to comply with the limits for a Class B digital device, pursuant to Part 15 of the FCC Rules. These limits are designed to provide reasonable protection against harmful interference in a residential installation. This equipment generates uses and can radiate radio frequency energy and, if not installed and used in accordance with the instructions, may cause harmful interference to radio communications. However, there is no guarantee that interference will not occur in a particular installation. If this equipment does cause harmful interference to radio or television reception, which can be determined by turning the equipment off and on, the user is encouraged to try to correct the interference by one or more of the following measures:

- Reorient or relocate the receiving antenna.
- Increase the separation between the equipment and receiver.
- Connect the equipment into an outlet on a circuit different from that to which the receiver is connected.
- Consult the dealer or an experienced radio/TV technician for help.

Changes or modifications not expressly approved by the party responsible for compliance could void the user's authority to operate the equipment.

Caution: Changes or modifications not expressly approved by Harman could void the user's authority to operate the equipment.

CONTENTS

INTRODUCTION	3
OVERVIEW	3
FEATURES	3
PACKAGE CONTENTS	4
SPECIFICATIONS	5
DX-TX-4K60	5
DX-RX-4K60	6
TRANSMISSION DISTANCE	7
PANEL DESCRIPTION	7
DX-TX-4K60 TRANSMITTER	7
DX-RX-4K60 RECEIVER	8
PINOUT INFORMATION	10
RS232	10
TWISTED PAIR CABLE	10
RJ-45 LEDS	11
QUICK REFERENCE TABLES FOR MODES	12
DIP SWITCH FUNCTION	15
#1 TOGGLE SETTINGS	15
#2 TOGGLE SETTINGS	15
#3 TOGGLE SETTINGS	16
SCENARIOS / DIP SWITCH SETTINGS TABLE	17
INSTALLATION AND WIRING	18
INSTALLATION	18
WIRING	18
STEPS FOR DEVICE WIRING	18
NETLINX BINDING OF DXLINK MODULES WITH AN ENOVA DGX SWITCHER	21
AVOIDING NETWORK (ETHERNET) LOOPS	22
APPLYING POWER	22
CONFIGURING USB FOR USE WITH A DGX OR DVX	23
ID PUSHBUTTON OPERATION	24
ID PUSHBUTTON BOOT STATES AND LED BEHAVIOR	27
RS232 AND IR OPERATIONS	28
RS232 OPERATIONS	28
IR OPERATIONS	29
NETWORK CONFIGURATION	31
STATIC IP MODE – DEFAULT PARAMETERS	31
DHCP MODE	31
TCP/IP ADDRESS CONFIGURATION	32
OFFLINE RECOVERY MECHANISM	32
NETLINX PROGRAMING	33
DEVICE NUMBERING AND PORTS	33
NELINX CONTROL IN ENDPOINT MODE (SWITCHER)	33
SEND COMMANDS TO CONTROL A DEVICE	34
TELNET CONTROL	35
NETLINX CONTROL IN ENDPOINT MODE (STANDALONE)	35

SEND COMMANDS TO CONTROL A DEVICE.....	36
TELNET CONTROL.....	37
WEB UI CONTROL.....	37
WEB UI CONTROL.....	39
PREPARATIONS BEFORE LOGGING INTO WEB UI.....	39
WEB UI OF DX-TX-4K60.....	40
WEB INTRODUCTION.....	40
WEB UI OF DX-RX-4K60.....	51
WEB UI INTRODUCTION.....	52
FIRMWARE UPGRADE.....	64
UPGRADE FIRMWARE THROUGH NETLINX.....	64
BEFORE YOU START.....	64
TRANSFERRING KIT FILES.....	64
UPGRADE THE FIRMWARE THROUGH USB PORT.....	65
APPENDIX A: FACTORY DEFAULT CONFIGURATION.....	66
APPENDIX B: TELNET COMMANDS.....	68
APPENDIX C: ICSP COMMANDS.....	75
DX-TX-4K60.....	75
DX-RX-4K60.....	92
DX-TX-4K60&DX-RX-4K60 COMMANDS.....	113
WARRANTY TERMS AND CONDITIONS.....	117

Introduction

Overview

The Transmitters and Receiver are designed for transmission of an HDMI signal over twisted pair cable up to 328 feet (100 m). Functionality is briefly described below.

DX-TX-4K60

The DX-TX-4K60 is an HDMI transmitter with 4K@60Hz 4:4:4 and HDCP 2.2 compatibility. It receives an HDMI signal and an audio signal from a source device. The audio can be either digital audio embedded with the HDMI, or analog stereo audio. Both the video and audio are transported over twisted pair cable to an Enova DGX Digital Media Switcher, an applicable Enova DVX Solution, or directly to a DX-RX-4K60. The RS-232 port on a DX-TX-4K60 supports bidirectional serial data via the twisted pair cable to/from the RS-232 port on a DX-RX-4K60. The IR TX and IR RX ports on a DX-TX-4K60 each support unidirectional IR data via the twisted pair cable to/from the IR RX and IR TX ports on a DX-RX-4K60. The USB Host / Device ports on a DX-TX-4K60 support transmitting USB data via the twisted pair cable to/from a DX-RX-4K60. It can be controlled through sending ICSP commands from a NetLinX Central Controller and also supports CEC control and pass through to control the 3rd-Party devices.

DX-RX-4K60

The DX-RX-4K60 is an HDMI receiver with 4K@60Hz 4:4:4 and HDCP 2.2 compatibility. It receives an HDMI signal with embedded audio over twisted pair cable from an Enova DGX Digital Media Switcher, an applicable Enova DVX Solution, or directly from a DX-TX-4K60. The RS-232 port on a DX-RX-4K60 supports bidirectional serial data via the twisted pair cable to/from the RS-232 port on a DX-TX-4K60. The IR TX and IR RX ports on a DX-RX-4K60 each support unidirectional IR data via the twisted pair cable to/from the IR RX and IR TX ports on a DX-TX-4K60. The USB Host and Device ports on a DX-RX-4K60 each support transmitting USB data via the twisted pair cable to/from the USB Device and Host ports on a DX-TX-4K60. The DX-RX-4K60 features SmartScale® Technology (integrated EDID output scaling) to ensure an appropriate output resolution, plus it supports a Manual (override) option for setting up custom resolutions and a Bypass option. It can be controlled through sending ICSP commands from a NetLinX Central Controller and also supports CEC control and pass through to control 3rd-Party devices.

These DXLink products support several different modes which are available for system setup and use. For a brief explanation of the modes please refer to the "Quick Reference Table".

Features

- Supports 4K@60Hz 4:4:4 8bit and HDCP 2.2;
- SmartScale® on the Receivers works to automatically recognize any device's supported resolutions and signal type parameters, allowing updating source and destination devices without manual setup. Also included is the ability to control detailed timing parameters for customized video output formats. (SmartScale is the ability to configure the scaling output by automatically selecting destination defined resolutions.);
- Supports USB1.1 and USB2.0 Host or device connections set by the Mode switch on the front panel, and supports hosts like a Desktop or Laptop and USB devices like keyboards, mice, and cameras;
- Standard twisted pair cable saves time and installation effort;
- Transports video signals over distances up to 100m/330ft via DXLINK ports via Cat 6/6a/7 cable;
- Supports CEC control and pass through;

-
- The 232 port (RS-232 serial) supports bidirectional transfer of serial data between Central Controller and TX/RX (Endpoint Mode);
 - The IR port supports bidirectional transfer of IR data between Central Controller and RX (Endpoint Mode);
 - The DX-TX-4K60 transmitter supports HDMI loop out for connecting a local display;
 - Embedded Audio in in Transmitter and de-embedded Audio out in Receiver;
 - Power over DXLink (twisted pair cable) support when used with a switcher or with an approved AMX Power over DXLink device;
 - DXLink modules are compatible with all V Style versatile mounting options including rack, surface, and pole;

Package Contents

DX-TX-4K60:

- 1 x DX-TX-4K60 Transmitter
- 1 x 12V Power Cord
- 1 x AC Power Cable with US Pins
- 1 x AC Power Cable with CN Pins
- 1 x AC Power Cable with EU Pins
- 1 x AC Power Cable with UK Pins
- 1 x Broadband IR Receiver (30KHz-50KHz)
- 1 x IR Emitter
- 1 x Phoenix Male Connector (3.5mm, 3 Pins)
- 1 x Phoenix Male Connector (3.5mm, 2 Pins)
- 2 x Mounting Bracket (with Screws)
- 4 x Rubber foot

DX-RX-4K60:

- 1 x DX-RX-4K60 Receiver
- 1 x DC 12V Power Cord
- 1 x AC Power Cable with US Pins
- 1 x AC Power Cable with CN Pins
- 1 x AC Power Cable with EU Pins
- 1 x AC Power Cable with UK Pins
- 1 x Broadband IR Receiver (30KHz-50KHz)
- 1 x IR Emitter
- 1 x Phoenix Male Connector (3.5mm, 3 Pins)
- 1 x Phoenix Male Connector (3.5mm, 2 Pins)
- 2 x Mounting Bracket (with Screws)
- 4 x Rubber foot

Specifications

DX-TX-4K60

Technical	
Input/Output	1 x HDMI IN, 1 x Audio IN, 1 x HDMI OUT, 1 x ICS LAN 10/100, 1 x IR RX, 1 x IR TX, 1 x RS-232, 1 x DXLINK, 1 x USB HOST, 1 x USB, 1 x DC 12V IN
Input Signal Type	HDMI with 4K@60Hz 4:4:4 HDCP 2.2
Input Resolution Supported	<p>VESA: 800x600⁸, 1024x768⁸, 1280x768⁸, 1280x800⁸, 1280x960⁸, 1280x1024⁸, 1360x768⁸, 1366x768⁸, 1440x900⁸, 1600x900⁸, 1600x1200⁸, 1680x1050⁸, 1920x1200⁸</p> <p>SMPTE: 1280x720^{6,7,8}, 1920x1080^{6,7,8}, 3840x2160^{2,3,5,6,8}, 4096x2160^{2,3,5,6,8} 1 = at 23.98 Hz, 2 = at 24 Hz, 3 = at 25 Hz, 4 = at 29.97 Hz, 5 = at 30 Hz, 6 = at 50 Hz, 7 = at 59.94 Hz, 8 = at 60 Hz</p> <p>Established Timing including interlaced formats: 1280 x 1024 @ 75 Hz, 1152 x 870 @ 75 Hz 1024 x 768 @ 60 Hz, 70 Hz, 75 Hz, 87 Hz, 832 x 624 @ 75 Hz 800 x 600 @ 56 Hz, 60 Hz, 75 Hz, 720 x 400 @ 70 Hz, 88 Hz 640 x 480 @ 60 Hz, 67 Hz, 72 Hz, 75 Hz</p> <p>CEA Video Information Code (VIC) Formats: VIC = 1, 640 x 480p 59.94/60 Hz 4:3 VIC = 2, 720 x 480p 59.94/60 Hz 4:3 VIC = 3, 720 x 480p 59.94/60 Hz 16:9 VIC = 4, 1280 x 720p 59.94/60 Hz 16:9 VIC = 5, 1920 x 1080i 59.94/60 Hz 16:9 VIC = 6, 720(1440) x 480i 59.94/60 Hz 4:3 VIC = 7, 720(1440) x 480i 59.94/60 Hz 16:9 VIC = 14, 1440 x 480p 59.94/60 Hz 4:3 VIC = 15, 1440 x 480p 59.94/60 Hz 16:9 VIC = 16, 1920 x 1080p 59.94/60 Hz 16:9 VIC = 17, 720 x 576p 50 Hz 4:3 VIC = 18, 720 x 576p 50 Hz 16:9 VIC = 19, 1280 x 720p 50 Hz 16:9 VIC = 20, 1920 x 1080i 50 Hz 16:9 VIC = 21, 720(1440) x 576i 50 Hz 4:3 VIC = 22, 720(1440) x 576i 50 Hz 16:9 VIC = 29, 1440 x 576p 50 Hz 4:3 VIC = 30, 1440 x 576p 50 Hz 16:9 VIC = 31, 1920 x 1080p 50 Hz 16:9 VIC = 32, 1920 x 1080p 23.97/24 Hz 16:9 VIC = 33, 1920 x 1080p 25 Hz 16:9 VIC = 34, 1920 x 1080p 29.97/30 Hz 16:9 VIC = 39, 1920 x 1080i 50 Hz 16:9 VIC = 41, 1280 x 720p 100 Hz 16:9 VIC = 42, 720 x 576p 100 Hz 4:3 VIC = 43, 720 x 576p 100 Hz 16:9 VIC = 44, 720(1440) x 576i 100 Hz 4:3 VIC = 45, 720(1440) x 576i 100 Hz 16:9 VIC = 47, 1280 x 720p 119.88/120 Hz 16:9 VIC = 48, 720 x 480p 119.88/120 Hz 4:3 VIC = 49, 720 x 480p 119.88/120 Hz 16:9</p>
Input Video Level	0.5-1.0 Vp-p
Maximum Pixel Clock	600 MHz
Output	1 x DXLINK OUT, 1 x HDMI OUT
Output Signal Type	HDMI with 4K@60Hz 4:4:4; HDBaseT 2.0
Video Impedance	100 Ω
Audio Format Supported	HDMI IN: Fully supports audio formats in HDMI 2.0 specification, including PCM 2.0/5.1/7.1, Dolby TrueHD, Dolby Atmos, DTS-HD MA and DTS:X Analog AUDIO IN: stereo
General	
Operating Temperature	0°C to 40°C (32°F to 104°F)
Storage Temperature	-20°C to 70°C (4°F to 158°F)
Humidity	5% to 85%, non-condensing
ESD Protection	Human-body Model:

	±8kV (Air-gap discharge) ±5kV (Contact discharge)
Surge Protection	Voltage: ±1 kV
Power Supply	DC 12V 3A or powered by Enova DGX Switchers/DVX Switchers
Power Consumption (Maximum)	Local 12V Power Supplied: 12.5W Power over DXLink Supplied: 13.0W
Device Dimension (W x H x D)	220mm x 25mm x 160mm /8.66" x 0.98" x 6.30" (Without Mounting Brackets)
Product Weight	Approx. 0.9 kg / 2.0 lb
Certification	CE/FCC/ETL/PSE/RCM

DX-RX-4K60

Technical	
Input/output	1 x DXLINK, 1 x IR TX, 1 X IR RX, 1 x RS232, 1 x ISC LAN10/100, 1 x AUDIO OUT, 1 x USB HOST (Type-B), 1 x USB DEVICE (Type-A), 1 x DC 12V IN
Output Signal Type	HDMI with 4k@60Hz 4:4:4, HDCP 2.2
Output Resolution Support	VESA: 800x600 ⁸ , 1024x768 ⁸ , 1280x768 ⁸ , 1280x800 ⁸ , 1280x960 ⁸ , 1280x1024 ⁸ , 1360x768 ⁸ , 1366x768 ⁸ , 1400x1050 ⁸ , 1440x900 ⁸ , 1600x900 ⁸ , 1600x1200 ⁸ , 1680x1050 ⁸ , 1920x1200 ⁸ SMPTE: 1280x720 ^{6,8} , 1920x1080 ^{6,8} , 3840x2160 ^{2,3,5,6,8} , 4096x2160 ^{2,3,5,8} 1 = at 23.98 Hz, 2 = at 24 Hz, 3 = at 25 Hz, 4 = at 29.97 Hz, 5 = at 30 Hz, 6 = at 50 Hz, 7 = at 59.94 Hz, 8 = 60 Hz, 9 = 75 Hz NOTE: <i>Scaler Mode: 3840x2160@60Hz RGB/YCbCr 4:4:4,</i> <i>4096x2160@60Hz RGB/YCbCr 4:4:4;</i> <i>Bypass Mode: 3840x2160@60Hz RGB/YCbCr 4:4:4,</i> <i>4096x2160@60Hz YCbCr 4:2:0.</i>
Output Video Level	0.5-1.0 Vp-p
Maximum Pixel Clock	600MHz
Output	1 x HDMI OUT, 1 x AUDIO OUT
Output Signal Type	HDMI
Video Impedance	100 Ω
Audio Format Supported	HDMI OUT: Bypass Mode: Fully supports audio formats in HDMI 2.0 specification, including PCM 2.0/5.1/7.1, Dolby TrueHD, Dolby Atmos, DTS-HD MA and DTS:X; Scaler Mode: PCM 2.0 Analog AUDIO IN/OUT: stereo
General	
Operating Temperature	0°C to 40°C (32°F to 104°F)
Storage Temperature	-20°C to 70°C (-4°F to 158°F)
Humidity	5% to 85%, non-condensing
Surge Protection	Voltage: ±1 kV
Power Supply	DC 12V 3A or powered by Enova DGX Switchers/DVX Switchers
Power Consumption (Maximum)	Local 12V Power Supplied: 18.2W Power over DXLink Supplied: 20.2W
Device Dimension (W x H x D)	220mm x 25mm x 160mm /8.66" x 0.98" x 6.30" (Without Mounting Brackets)
Product Weight	Approx. 1.0 kg / 2.2 lb
ESD Protection	Human-body Model: ±8kV (Air-gap discharge) ±5kV (Contact discharge)
Certification	CE/FCC/ETL/PSE/RCM

Transmission Distance

Cable Type	Range	Supported Video
Cat 6 Cat 6a/7	70m/230ft 100m/330ft	1080P@60Hz, 48bpp 1080P@60Hz, 3D 4K@30Hz, 4:4:4, 32bpp 4K@60Hz, 4:2:0, 32bpp 4K@60Hz, 4:4:4, 24bpp

Hardware Description

DX-TX-4K60 Transmitter

Front View

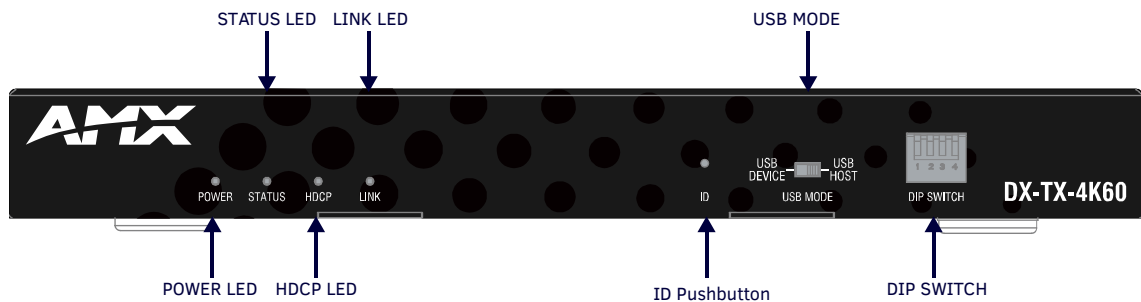

- **POWER LED:** On indicates when the Transmitter is powered on.
- **STATUS LED:** On indicates the Transmitter is connected and communicating properly.
- **HDCP LED:** On indicates HDCP-protected content is being transmitted, Blinking indicates Non-HDCP Protected content is being transmitted, and Off indicates No content is being transmitted.
- **LINK LED:** On indicates the ethernet cable is connected and an active link is established, Blinking indicates receiving ethernet data packets.
- **ID Pushbutton:** Place the transmitter in ID mode for setting the NetLinx ID (Device only) and provides additional functionality, such as placing the device in Static IP mode or DHCP Mode (See “*ID Push Button Operation*” Section).
- **USB MODE:** Switch between USB Host (default setting) or USB device mode.
- **DIP SWITCH:** For LAN port, DXLINK and network control modes configuration (See “*DIP Switch Function*” section).

Rear View

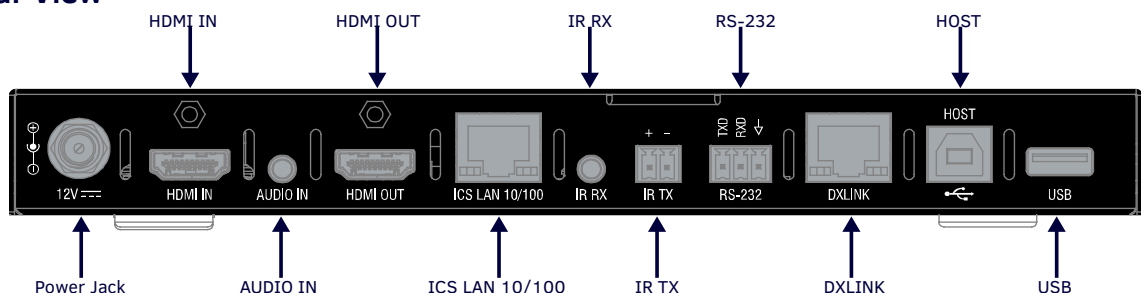

- **Power Jack:** Connect to the DC 12V power adapter provided.
- **HDMI IN:** Connect to an HDMI Source. Support digital video and embedded digital audio. The HDMI connector also supports a DVI-D signal with the use of a DVI-to-HDMI cable adapter.

- **AUDIO IN:** Audio input, 3.5mm Mini-Stereo Jack.
 - **HDMI OUT:** Connect to an HDMI display. Support digital video and embedded digital audio.
 - **ICS LAN 10/100:** RJ45 port, TCP/IP Port. For ethernet 10/100 connectivity (receive commands or download upgrade file).
 - **IR RX:** Connect to an IR receiver provided.
 - **IR TX:** Connect to an IR emitter provided.
 - **RS-232:** Connect an RS232 device for serial communication or RS232 pass-through.
 - **DXLINK:** Connect to a DXLink receiver such as DT-RX-4K60 or DXLink input boards via the twisted pair cable.
 - **HOST:** USB Type-B connector. Connect to a USB host device.
- NOTE:** When you want to connect USB devices to the Host PC of the transmitter, ensure the USB Mode Switch on front panel is set to “USB HOST” position.
- **USB:** USB Type-A connector. Connect to USB devices (such as keyboard, mouse, or interactive whiteboard).

DX-RX-4K60 Receiver

Front View

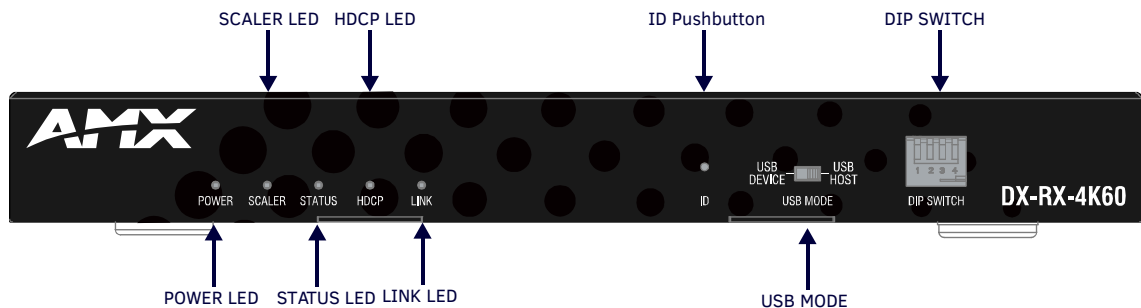

- **POWER LED:** On indicates when the receiver is powered on.
- **SCALER LED:** On indicates the video scaler is on active, and Off indicates the scaler is straightway.
- **STATUS LED:** On indicates the receiver is programmed and communicating properly.
- **HDCP LED:** On indicates HDCP-protected content is being transmitted, Blinking indicates Non-HDCP Protected content is being transmitted, and Off indicates No content is being transmitted.
- **LINK LED:** On indicates the ethernet cable is connected and an active link is established, and Blinking indicates receive ethernet data packages.
- **ID Pushbutton:** Places the receiver in ID Mode for setting the NetLinx ID (Device only) and provides additional functionality, such as placing the device in Static IP mode or DHCP mode.
- **USB MODE:** Switch to USB Host (default setting) or USB device mode.
- **DIP SWITCH:** For LAN port, DXLINK and network control modes configuration (See “DIP Switch Function” section).

Rear View

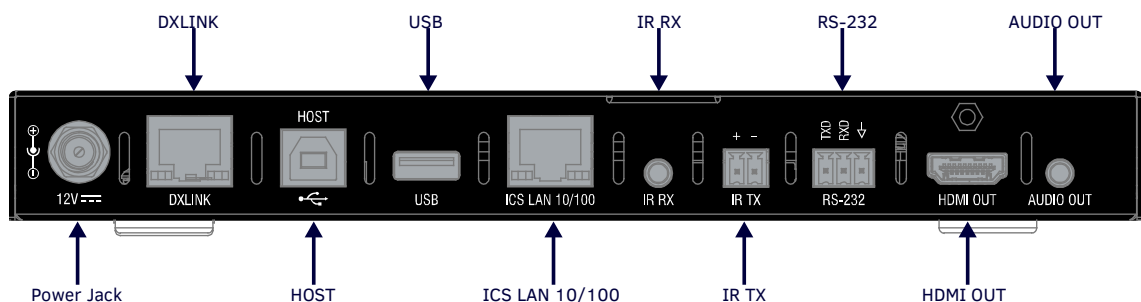

- **Power Jack:** Connect to the DC 12V power adapter provided.
- **DXLINK:** Connect to DXLink transmitter such as DX-TX-4K60 or output boards via a twisted pair cable.

-
- **HOST:** USB Type-B connector. Connect to a USB host device.
NOTE: *When you want to connect USB devices to the Host PC of the receiver, ensure the USB Mode Switch on front panel is set to “USB HOST” position.*
 - **USB:** USB Type-A connector. Connect to USB devices (such as keyboard, mouse, interactive whiteboard).
 - **ICS LAN 10/100:** RJ45 port, TCP/IP Port. For ethernet 10/100 connectivity (receive commands or download upgrade file).
 - **IR RX:** Connect to an IR receiver.
 - **IR TX:** Connect to an IR emitter.
 - **RS-232:** Connect a RS232 device for serial communication or RS232 pass-through.
 - **HDMI OUT:** Connect to an HDMI display.
 - **AUDIO OUT:** 3.5mm stereo jack. Connect to an audio device for analog audio output.

Pinout Information

RS232

Connects to a RS232 device with the 3-pole, 3.5mm captive screw connectors. Wire as shown below:

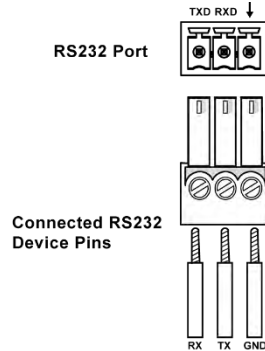

Twisted Pair cable

The pinout in the following picture is for twisted pair cable that connects to the ICS LAN 10/100 connector (on modules only) or to the DXLink connector on all Transmitters and Receivers. Use either the T568A or T568B pinout specification for termination of the twisted pair cable used between the units in a standalone setup or between Transmitters and Receivers and an enclosure in a full system.

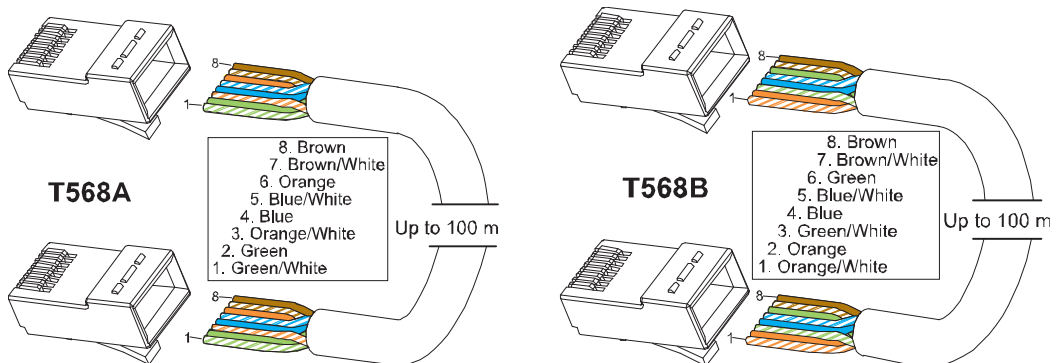

In a typical installation, the cables should be stretched to their full length between Transmitters and Receivers and the enclosure or between units in a standalone system. Service loops or coils of the cable may reduce the overall cable performance and should be minimized whenever possible.

RJ-45 LEDs

ICS LAN 10/100 Connector LEDs (DXLINK Modes only)

The following information applies to the LEDs on the ICS LAN 10/100 connector on DXLink modules.

Note that #1 Toggle must be set to ON or ICS LAN functionality will not be provided.

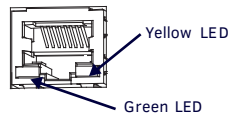

ICS LAN 10/100 Connector LEDs
(Modules only)

Green LED:

On: Link status is active.

Off: Link status is not active.

Yellow LED:

On: Speed status is 10/100 Mbps.

DXLINK Connector LEDs

The following information applies to the LEDs located on the DXLink (RJ-45) connectors on the rear of DXLink units.

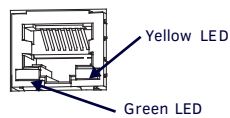

DXLINK (RJ-45) LEDs

Green LED:

On: Connection established.

Off: Connection not established.

Yellow LED:

On: Authenticated HDCP.

Flashing: Video active; no HDCP.

Off: No Video.

Quick Reference Tables for Modes

The modes listed in the following three tables are those supported by DXLink Transmitters and Receivers. The Quick Reference Tables are intended to help users navigate the many modes available for system setup and use. For complete information on any of the modes listed, see the relevant sections or chapter referenced at the end of the Descriptions.

Quick Reference Table - Modes for Handling System Architecture	
Mode	Description
DXLink Modes	<p>DXLink Modes refer to the type of physical components and how they are connected to make up the system. When Transmitters and Receivers are cabled into a system and powered on, they automatically detect the DXLink Mode they are being used in.</p> <p>Endpoint Mode:</p> <ul style="list-style-type: none"> When the system is setup to use Transmitters and/or Receivers with an Enova DGX Digital Media Switcher or an applicable Enova DVX Solution, the system is in Endpoint Mode. <p>Or</p> <ul style="list-style-type: none"> When a TX is directly connected to an RX but, in addition, the TX and/or RX is connected to a NetLinx Central Controller via a LAN or directly connected to the Controller, the system is in Endpoint Mode. <p>Extender Mode:</p> <ul style="list-style-type: none"> When a TX is directly connected to an RX, the system is in Extender Mode. <p>For further information, reference #2 Toggle DIP switch settings for DXLink Mode and DXLink System SEND_COMMANDS.</p>

Quick Reference Table - Modes for Handling Addressing/Networking	
Mode	Description
IP Addressing Modes	<p>IP Addressing Modes refer to network connection settings. By default, all network connection settings are turned OFF.</p> <p>Static IP Mode:</p> <ul style="list-style-type: none"> This mode configures the network connection to one stable IP address the device will use continuously. <p>DHCP Mode:</p> <ul style="list-style-type: none"> This mode configures the network connection to choose a new IP address for each network session. <p>Change IP Addressing Modes, send commands through NetLinx (see “APPENDIX C: ICSP Commands”), press ID Pushbutton or set on the web UI.</p>
ID Mode	<p>ID (Identify) Mode refers to the protocol for enabling a user to establish device addresses. This Mode, accessible through NetLinx Studio, places the entire system on hold while it waits for an event from a NetLinx device in the named system (e.g., pressing the ID Pushbutton on the TX or RX). For further information, see “Assign a Device Address (ID Mode)” part of “DIP Switch Function” section.</p>
Ethernet Modes	<p>Ethernet Modes refer to the LAN configuration settings.</p> <p>Auto Mode:</p> <ul style="list-style-type: none"> This mode configures the LAN driver to discover its own settings based on the network it is connected to.

Quick Reference Table - Modes for Handling Addressing/Networking

Mode	Description
Ethernet Modes (continued)	<p>Speed/Duplex Mode:</p> <ul style="list-style-type: none">• This mode configures the LAN driver to calculate its speed as either 10 or 100 and to communicate in either half- or full-duplex.• Ethernet Mode discovery and configuration information is available through Telnet commands. <p>Change or get Ethernet Modes, send Telnet commands, see the “<i>APPENDIX C: ICSP Commands</i>” section.</p>
Central Controller Connection Modes	<p>Central Controller Connection Modes refer to the modes of communication used for connection to the Central Controller as specified via the SET CONNECTION Telnet command and web UI.</p> <p>Auto Mode: This mode utilizes TCP communication. It looks for a matching System Number and attempts to come online with the first Central Controller it sees with that System Number.</p> <p>TCP URL Mode: TCP; the Central Controller is specified via URL.</p> <p>UDP URL Mode: UDP; the Central Controller is specified via URL.</p> <p>NDP Mode (Default): UDP; utilizes the NDP binding process to assign the DXLink Module (the physical device) to a Central Controller (or Virtual Central Controller) via NetLinx Studio. Once bound, communications are conducted via UDP.</p>
Auto-setup Mode	<p>In auto-setup mode, endpoints are automatically discovered by and connected to an Enova DGX 100 Series Switcher using a single IP address. For this mode, all of the following requirements must be met. If not, the endpoint will no longer reside in auto-setup mode and must be either bound to the integrated Central Controller or reconfigured to meet the requirements.</p> <ul style="list-style-type: none">• Endpoint must be connected to a DXLink Input Board in an Enova DGX 100 Series Switcher (or Enova DGX with upgraded 100 Series CPU).• Endpoint must have IP mode set to DHCP for setup (self-configures to Static IP on private LAN).• Endpoint must have the Central Controller connection type set to NDP.• Endpoint must not be bound to a Central Controller via NDP (traditional binding process).• Endpoint DIP switch setting for Toggle #3 (network connectivity) is ignored while in auto-setup mode <p>IMPORTANT: <i>If auto-setup is being used, Telnet is the only way to access some of the network settings. Also note that some network settings will disable auto-setup. For additional information on the auto-setup feature, see “the Hardware Reference Manual – Enova DGX 100 Series Digital Media Switchers”.</i></p>

Quick Reference Table - Modes for Handling Video Processing

Mode	Description
Scaling	<p>Scaling Modes refer to how the system alters or maintains a source device's resolution as it is passed along to the destination device. The Scaling Mode can be set through RX Web UI, with SEND_COMMANDs, or through DGX Configuration Software when scaling is being done via an Enova DXLink Output Board.</p> <p>Auto Mode (Default):</p> <ul style="list-style-type: none">• Auto Mode (SmartScale®) allows the destination device to choose the resolution it needs. <p>Manual Mode:</p> <ul style="list-style-type: none">• Manual Mode allows the user to configure the resolution the video will display through a destination device. <p>Bypass Mode:</p> <ul style="list-style-type: none">• Bypass Mode allows the video signal to display over the destination device without altering the signal's resolution.

DIP Switch Function

The DIP Switch is located on the front panel of DX-TX-4K60 and DX-RX-4K60, the functions is described as follows.

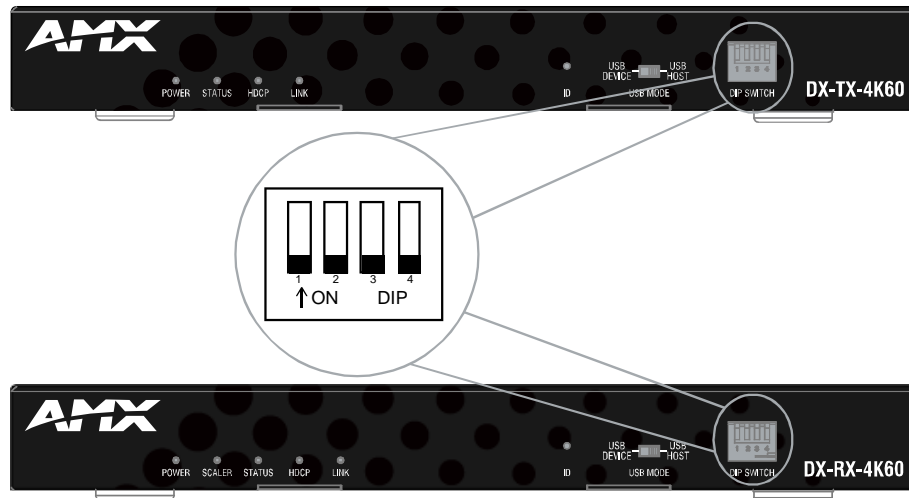

- #1 Toggle is used for enabling/disabling the physical ICS LAN 10/100 port.
- #2 Toggle is used for setting Modules to either automatically or manually determine the DXLink Mode.
- #3 Toggle is used for enabling/disabling network connectivity of the DXLink Transmitter or Receiver to a connected NetLinX Central Controller (used for IR ports, serial ports, and commands to the DXLink unit).
- #4 Toggle is not functional.

#1 Toggle Settings

Setting DIP Switch #1 to Enable/Disable Access to LAN 10/100 Port.

- OFF (Default): When the #1 Toggle is set to OFF, network activity over the ICS LAN 10/100 port is disabled.
- ON: When the #1 Toggle is set to ON, network activity over the ICS LAN 10/100 port is enabled.

Installation Options:

- Option A: For a network connection between a Transmitter and a Receiver where only one of them is connected to a LAN, set the #1 Toggle to ON for the unit that is connected to the network.

Note: Option A – Do not connect both the Transmitter and the Receiver to a common LAN as a network loop will result.

- Option B: When a Transmitter or Receiver is connected to a DXLink input or output on an Enova DGX Digital Media Switcher or Enova DVX switcher, the switcher provides a network connection allowing the Transmitter or Receiver to appear in the online tree in NetLinX Studio (#3 Toggle must be set to ON). For connecting the Transmitter or Receiver to other equipment using the ICS LAN 10/100 port, the #1 Toggle must be set to ON.

Note: Option B: Because the DXLink connection carries network activity passed from the switcher, do not connect the ICS LAN 10/100 port on the Transmitter or Receiver to the same LAN as the switcher because a network loop will result.

#2 Toggle Settings

#2 Toggle can be set to automatically or manually select the DXLink Mode (to either Extender or Endpoint) for a given Transmitter/Receiver Module. Default state for #2 Toggle OFF is auto selection of DXLink Mode based on connection to another device. When it's ON, the default is Endpoint Mode (used for Central Controller controlled serial/IR data transfer).

- OFF (Default): When #2 Toggle is set to OFF, the Transmitter and Receiver will each auto-discover* what

type of DXLink equipment they are connected to and will automatically self-configure to be in one of two DXLink Modes based on the connection:

Extender Mode – This mode is automatically selected when a TX and RX are connected directly to each other (a standalone pair). The Transmitter and Receiver act like a simple extender, and serial and IR data is passed through them.

Endpoint Mode – This mode is automatically selected when a module is connected directly to a DXLink port on a switcher. Serial and IR operations are handled by the host providing control of endpoints. The Central Controller's programming specifies where IR and serial commands are sent (this is handled independently from the routing of the video signals).

* Any time the DXLink connection is re-established or power is cycled on a module, the auto-discovery process will take place, as long as the #2 Toggle remains in the OFF position.

- **ON:** When #2 Toggle is set to ON, the auto-discover feature is disabled and the module can be manually set to either Endpoint Mode (default) or Extender Mode. In Endpoint Mode, when the module is connected to a switcher or a separate NetLinx Central Controller **, IR and serial operation are only handled via the host.

** When standalone modules require IR and/or Serial control by a separate NetLinx Central Controller, then they need to be in Endpoint Mode. Only one must be connected via the ICS LAN 10/100 port to the Central Controller or to a LAN with the Central Controller on it. This requires #1 Toggle to be ON to enable the ICS LAN port. #2 Toggle needs to be ON to place the modules in Endpoint Mode (if needed), and #3 Toggle needs to be ON to enable network connectivity.

Note: On either setting, the DXLink Mode may be set via `SEND_COMMANDS` (see "APPENDIX C: ICSP Commands" section). When #2 Toggle is set to the OFF position, the auto-discovery process will overwrite the DXLink Mode setting. However, when the #2 Toggle is set to the ON position, auto-discovery is disabled and the mode set by `SEND_COMMANDS` will persist (i.e., the DXLink Mode setting cannot be overwritten).

- Setting DIP Switch #3 for Network Connectivity, default setting is OFF, the transmitter and receiver will not try to connect to the network and will not acquire an IP address;
- Setting DIP Switch #4 is Reserved.

Note:

- For easiest access to the DIP switch toggles, we recommend setting them before installation.
- DIP switch settings on any of these DXLink products are read only on reboot. After the settings are read, any adjustments of the toggles will not be implemented and will not affect the system.

#3 Toggle Settings

The #3 Toggle is used for enabling/disabling network connectivity (IP addressing) of the DXLink Transmitter or Receiver. If enabled, it allows the Transmitter or Receiver to be configured to connect to a NetLinx Central Controller (used for controlling the DXLink unit and allowing Ethernet traffic).

- **OFF (default)** – When the #3 Toggle is set to OFF, the Transmitter or Receiver will not try to connect to the network and will not acquire an IP address.
- **ON** – When the #3 Toggle is set to ON, the Transmitter or Receiver will attempt to connect to the network via DHCP or static IP, depending on how the unit has been set up. The Transmitter and Receiver will not display in NetLinx Studio and will not accept commands or queries unless the #3 Toggle is ON.

Note: After the #3 Toggle is set to ON, a network connection is established, and the NetLinx Studio screen is refreshed, Transmitters and Receivers display in the Online Tree as Unbound NDP (Network Detect Proxy) Devices. To facilitate IRL and KIT file transfers, they can be bound to the integrated NetLinx Central Controller in a switcher or to another NetLinx Central Controller. A Virtual NetLinx Central Controller can also be used for file transfers.

Scenarios / DIP Switch Settings Table

The table below contains the most common scenarios for setting up Transmitter and Receiver as a standalone pair or with other equipment. Find the scenario in the table that you want to use and then set the Dip switches accordingly. A detailed explanation of functions for each toggle is provided above and on the previous page.

Common Scenarios	DIP Switch Toggle Settings			
Standalone Setup-TX/RX pair direct connection	1	2	3	4
AV signals only (plus serial/IR passthrough)	OFF	OFF	OFF	OFF
AV with Ethernet passthrough to networked device* (plus serial/IR passthrough)	ON	OFF	OFF	OFF
AV with NetLinx control of TX/RX unit and serial/IR ports**	ON	ON	ON	OFF
AV with NetLinx control of TX/RX unit and serial/IR ports, plus Ethernet passthrough to networked device*	ON	ON	ON	OFF
Switcher setup-TX/RX with ENOVA DGX/Soiecis 4K Switcher	1	2	3	4
AV signals only	OFF	OFF	OFF	OFF
AV with Ethernet passthrough to networked device*	ON	OFF	OFF	OFF
AV with NetLinx control of TX/RX unit and serial/IR ports	OFF	OFF	ON	OFF
AV with NetLinx control of TX/RX unit and serial/IR ports, plus Ethernet passthrough to networked device*	ON	ON	ON	OFF

* Connect the ICS LAN 10/100 port of the DXLink unit to the network device (e.g., laptop, IP controlled projector, AMX ICSLan EXB Device). In a standalone setup, connect the ICS LAN 10/100 port of the other DXLink unit to the network.

** In a standalone setup using NetLinx control of the DXLink serial/IR ports, only one of the DXLink units should be connected to the network (the unit with #1 Toggle enabled).

Installation and Wiring

Installation

Note: Before installation, please ensure the kit is disconnected from the power source.

Steps to install the device in a suitable location:

1. Attach the installation brackets to the enclosure using the screws provided in the package.
2. The bracket is attached to the enclosure as shown.

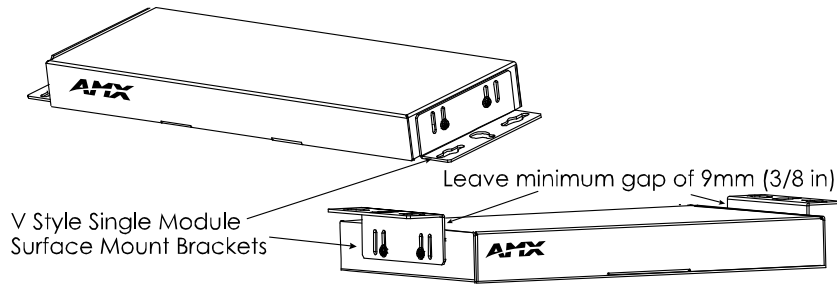

3. Attach the brackets to the surface you want to hold the unit against using the screws (not provided).
4. Repeat steps 1~3 to install the receiver.

Note: Do not install it upside down. When mounting under a surface, the module should be mounted upright and lowered in the mounting bracket slots to provide an airflow gap between the surface and the vent holes. If not using V Style brackets, be sure to leave a gap between the top of the unit and the surface for heat to escape.

Wiring

Warnings:

- Before wiring, disconnect the power from all devices.
- Before wiring, please see "DIP Switch Function" section to do the corresponding configurations.
- When connecting with a DGX switcher, power requirements must be determined. (See "Applying Power" of "Installation and Wiring" section).
- During wiring, connect and disconnect the cables gently.

Steps for Device Wiring

a) Extender Mode (Standalone)

A Transmitter and Receiver standalone pair can work together as an extender solution for transmission of HDMI over twisted pair cable up to 328 feet (100 m).

1. Connect an HDMI source (such as a Blu-ray Player or PC) to the HDMI IN port of the transmitter with a high quality HDMI cable.
2. Connect HDMI display (such as a TV) to HDMI OUT port of transmitter or receiver.
3. Connect a high quality category cable to DXLINK ports between transmitter and receiver.
4. For additional control options:
 - IR Pass Through: Connect IR emitter to IR TX port of transmitter or receiver and connect IR receiver to IR RX port of receiver or transmitter. The source remote can control the source at display site or the display remote can control the display at the transmitter end.
 - USB Control: Switch USB MODE of transmitter/receiver to "USB HOST" position, and switch USB MODE of receiver/transmitter to "USB DEVICE" position. Connect a USB PC to USB HOST port of the transmitter/receiver and connect USB device (such as a keyboard or mouse) to USB port of the receiver/transmitter. The USB device can be connected to the host PC.
 - Ethernet Pass-Through: Connect ICSLAN 10/100 of the transmitter or receiver to the local area

network and connect the PC to ICSPAN port on the other receiver or transmitter.

- RS232 Pass-Through: Connect an RS232 device to RS232 port of transmitter or receiver.

5. Connect the transmitter and receiver to the DC 12V power adapters provided.

b) Endpoint Mode (Standalone)

A standalone DXLink TX/RX pair are connected directly to each other but, in addition, either the TX or RX is connected to a NetLinx Central Controller via a LAN or directly to the Controller.

1. Connect an HDMI source (such as a Blu-ray Player or PC) to HDMI IN port of the transmitter with a high quality HDMI cable.
2. Connect HDMI displays (such as a TV) to HDMI OUT port ports of transmitter and receiver.
3. Connect a high quality category cable to DXLINK ports between transmitter and receiver.
4. Connect ICSPAN port of transmitter/receiver to the local area network and connect a NetLinx Controller to the same local area network.
5. Connect a PC to either the ICSPAN port on a transmitter/receiver or the local area network.
6. Connect the transmitter and receiver to the DC 12V power adapters provided.

c) Endpoint Mode (Switcher)

The primary function of the Transmitters and Receivers is to work with compatible DXLink equipment as an endpoint solution for transmission of HDMI over twisted pair cable.

1. Connect an HDMI source (such as a Blu-ray Player or PC) to the HDMI IN port of the transmitter with a high quality HDMI cable.
2. Connect HDMI displays (such as a TVs) to HDMI OUT ports of transmitter and receiver.
3. Connect an analog audio source to Audio In port of the transmitter and connect an analog audio receiver to Audio Out of the receiver.
4. Connect the DXLink Out port of the transmitter to the DXLink In port of an Input board installed in a DGX Switcher.

Connect the DXLink In port of the receiver to the DXLink Out port of and Output board installed in a DGX switcher.

The Transmitter receives an HDMI signal and an audio signal from a source device. The audio can be either digital audio embedded with the HDMI signal, or analog stereo audio. Both the video and embedded audio are transmitted over twisted pair cable to the RJ-45 connector on the DXLink Input Board. The HDMI signal is then routed through any (or all) of the connectors on one or more output boards.

When the HDMI signal is routed through a DXLink Output connector to a Receiver, the Receiver sends the HDMI signal with embedded audio on to the destination device. The audio can also be output on the Receiver's stereo audio port.

In systems where DXLink Transmitters and Receivers are used in conjunction with a switcher (e.g., Enova DGX 1600), the cable runs from a Transmitter to a DXLink Input Board and from a DXLink Output Board to a Receiver can each be up to 328 feet (100 m).

See the following application diagrams.

Extender Mode (Standalone)

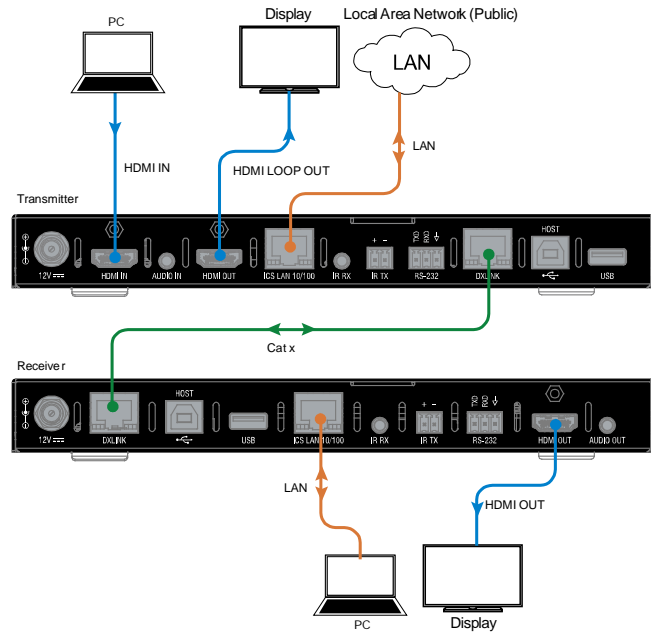

Endpoint Mode (Standalone)

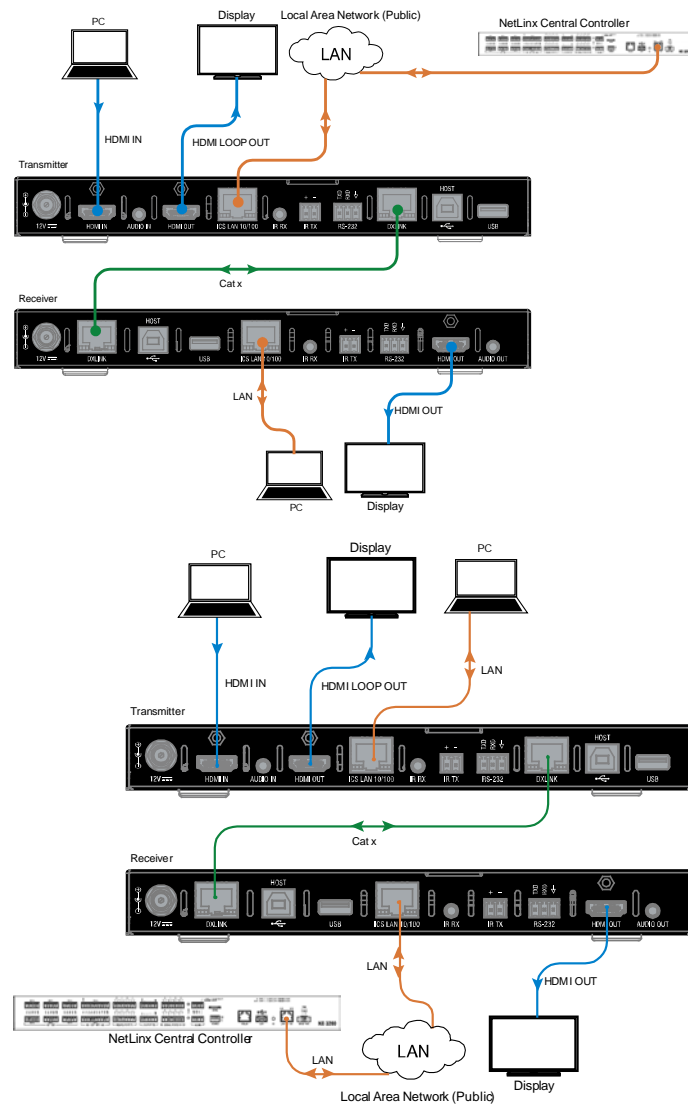

Endpoint Mode (Switcher)

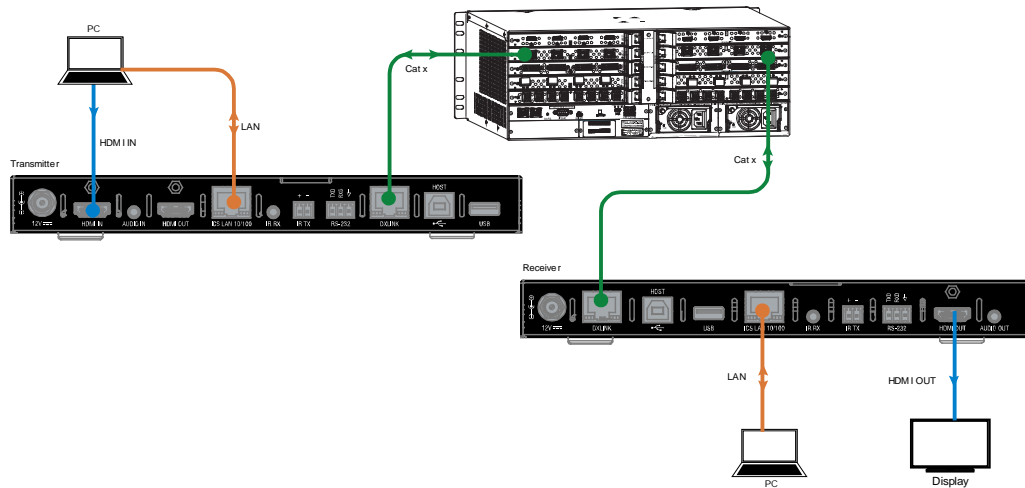

NetLink Binding of DXLink Modules with an Enova DGX Switcher

NOTE: If a DXLink module has been configured for auto-setup mode and then auto-setup mode has been disabled, the unit may take longer to appear in NetLinx Studio than expected (1-2 minutes).

DXLink Modules must have their DIP switch toggles set (See “DIP Switch Function” Section) before they will display as part of an Enova DGX system in NetLinx Studio (v4.0 or later is required).

In NetLinx Studio, the DXLink Modules can be bound to the integrated Central Controller by right-clicking on the device and selecting Network Bind/Unbind Device. This is considered the traditional method of binding. Auto-setup information (which does not require binding) is available in the *Hardware Reference Manual – Enova DGX 100 Series Digital Media Switchers*.

To bind DXLink Modules to Enova DGX integrated Central Controller:

1. Verify the following:
 - a) Verify that an Ethernet/RJ-45 cable is connected from the Enova DGX Switcher’s integrated Central Controller to the network (e.g., from the DGX’s LAN 100/1000 port to a LAN).
 - b) Verify that the target Module is connected via its DXLink connector to a DXLink Input or Output Board on the switcher.
 - c) Verify that the switcher is powered on.
2. Launch NetLinx Studio and open the Online Tree.
3. Bind the target Module to the integrated Central Controller:
 - a) Select and right-click the Module.
 - b) From the context sensitive menu, select Network Bind/Unbind Device (be sure the check box is selected).

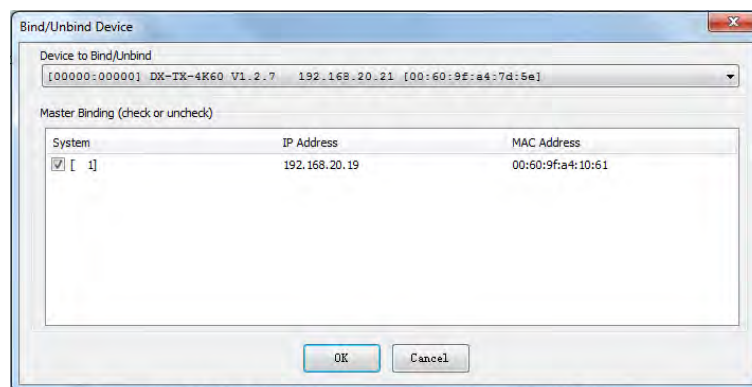

- c) Click OK.

Avoiding Network (Ethernet) Loops

CAUTION: *Be careful not to create a network (Ethernet) loop.*

Only one connection to a Public LAN is permitted within a switching system with DXLink support. Network loops must be avoided.

Example

In the example in following figures, a network loop was created when the Enova DGX was connected to a Public LAN and one of its DXLink 4K Receivers was connected to the same LAN. The DXLink 4K Receiver must be disconnected from the LAN. Remember to avoid network loops.

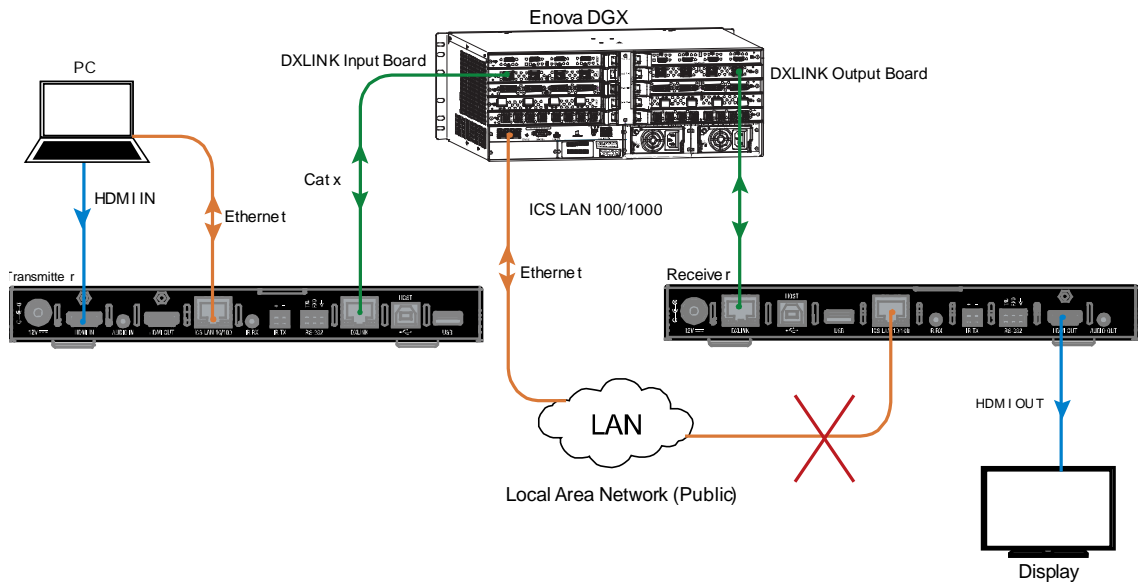

NOTE: *A network loop is created when an enclosure and one or more devices within the system are connected to a common Public LAN (or when two DXLink Modules are connected to the same network as a standalone pair).*

Applying Power

A desktop power supply is provided with each module. Automatic power supply to DXLink twisted pair transmitter and receiver units are as follows:

- Over local power by connecting the supplied desktop power supply to the 12V input
- Over the DXLink connection from a powered DXLink port on a DGX or DVX
- Over the DXLink connection using a PS-POE-AT-TC (FG423-84) or PDXL-2 (FG1090-170).

NOTE: *Local power takes precedence over DXLink power.*

Power Budget

For TXs and/or RXs connected to an Enova DGX, use the Enova DGX Configuration Tool (www.amx.com/enova) to determine power requirements of a configuration and if any DXLink TXs or RXs should use local power.

IMPORTANT: *If a desktop power supply is used to power the unit, it must be the one provided, which must not be altered in any way. AMX does not support the use of any other power supplies or PoE injectors as they may potentially damage the DXLink equipment.*

LED Status Indicators:

INDICATOR LEDS	Normal POWER UP	INDICATES
Power	Green	Power is applied
Status (NetLinx) Indicator	Green	Controller is programmed and communicating properly

INDICATOR LEDS	Normal POWER UP	INDICATES
HDCP Indicator	Yellow (On/Blinking)	HDCP-protected content is being transmitted or not
RX-Scaling	Blue or Off	Scaling on or off
NetLinx Link/Act	Green (ON/Blinking- #3 Toggle Off)	Active LAN connection to an AMX Network or receiving Ethernet data packets

Configuring USB for use with a DGX or DVX

1. The USB Modes can be set by USB DIP Switch on the front panel of the transmitter/receiver. By default, the transmitter is set to HOST mode and the receiver is set to Device mode.
2. There are two ways to apply power for the DXLink Module(s). One is with an external power supply, and the other is PoE from a DXLink port on a DGX or DVX. When powered via PoE, transmitters and receivers support HID devices. Local external power supplies must be used for transmitters and receivers to support USB 2.0 devices such as cameras.
3. When the USB DIP switch is set to Host, it will connect with a HOST device, such as a computer. The USB A/B on DXLink IN of DGX or DVX will connect with USB device, such as a camera.
4. When the USB DIP switch is set to Device, it will connect with a USB device, such as a camera. The USB A/B on DXLink OUT of DGX or DVX will connect with HOST device, such as a computer.

IMPORTANT:

- *A reboot is required for changes to the USB Mode switch to take effect.*
- *USB ports can also be used to upgrade firmware. See “Firmware Upgrade” section.*
- *A connected pair of TX and RX should not be set to the same USB mode.*

ID Pushbutton Operation

The ID Pushbutton is located on the right front of DXLink Modules

The ID Pushbutton can be used to perform five types of initial configuration settings:

1. Toggle between DHCP and static IP addressing (see below)
2. Assign a device address
3. Reset the unit to factory default settings, which affects the parameters but not the firmware version
4. Restore the unit to its factory firmware image, which affects both the firmware version and the parameters
5. Show IP Address (OSD)
6. Access the Field Update Mode (USB Firmware Update)

The functions performed depend on when and for how long the ID Pushbutton is pressed and held. ID Pushbutton functions can also be implemented using Telnet commands.

1. Toggling Between IP Addressing Modes: DHCP and Static IP

DXLink Modules support both DHCP and static IP addresses. When the #3 Toggle is ON (see DIP Switch Function), the Modules automatically use DHCP with link-local fallback. However, you can use a static IP address which can be set via a Telnet command (SET IP), or you can use the factory default static IP address. The default static IP address can be recalled at any time by resetting the unit to its factory default configuration.

The ID Pushbutton can be used to toggle between the DHCP and Static IP Modes.

To toggle between DHCP and Static IP Modes:

- (1) Once the Module has booted up, press and hold the ID Pushbutton until the Link and Status LEDs toggle back and forth approximately 10 times.
- (2) Release the ID Pushbutton when the LEDs begin to blink faster.
- (3) Once the IP mode change is complete, the Link and Status LEDs will turn off.
 - a. When the Pushbutton is released, the Module toggles either from static to dynamic (DHCP) IP addressing or vice versa and remains in that mode until the ID Pushbutton is used to set it again or a factory reset is performed.
 - b. The Module automatically reboots to complete the process.

2. Assign a Device Address (ID Mode)

The ID Pushbutton can be used in conjunction with the ID (Identify) Mode feature in NetLinx Studio. Press the ID Pushbutton long enough (the Link LED displays normally and Status LED blinks fast) to assign a device address to the Module (which must be bound to the Central Controller). The device must first be placed in ID Mode in NetLinx Studio or the momentary press will be ignored.

NOTE: The latest version of NetLinx Studio is available to download and install from www.amx.com. Refer to the NetLinx Studio online help for instructions on using the application.

To set the device address on a Module:

- (1) Check to be sure #3 Toggle on the bottom of the Module is set to ON.
- (2) In the NetLinx Studio Online Tree, select the Central Controller to which the Module is bound.
- (3) Right click, select **Device Addressing**.

The Device Addressing dialog box opens.

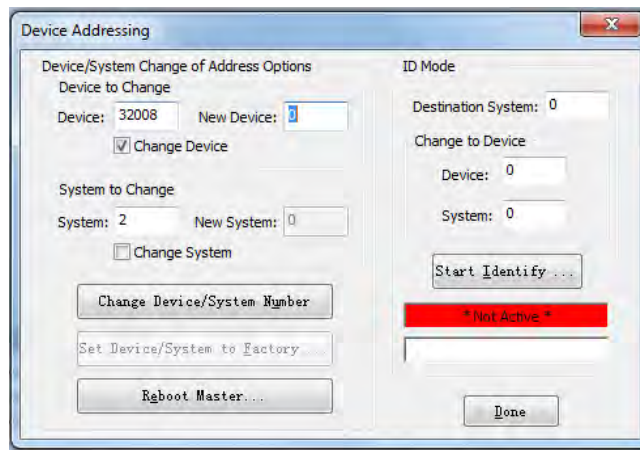

(4) In the ID Mode section, enter the Device and System numbers that you want assigned to the device in the appropriate text boxes.

(5) Click **Start Identify...** to place the named system in ID Mode.

The button changes to **Cancel Identify Mode** (click to cancel ID Mode).

The text box below the button displays a **Waiting...Press Cancel to Quit** message.

NOTE: *When in ID Mode, the entire system is put on hold while it waits for an event from any NetLinx device in the named system (e.g., pressing the ID Pushbutton on the Receiver). The device that generates the first event is the device that will be “identified.”*

(6) Press the ID Pushbutton on the Module long enough to accept new ID (Device number).

The Module will exhibit the following behavior:

- a. Respond with an ID Mode address response.
- b. Report its old address offline.
- c. Report its new address online.

The Online Tree will refresh to display the new device address for the Module.

NOTE: *NetLinx Studio (v4.0 or later) provides the ability to auto-increment IP Addresses and Hostnames as well as Device and System Numbers. Refer to the NetLinx Studio online help for details.*

3. Reset to Factory Default Settings

During power up, if the ID Pushbutton is held until the Link and Status LEDs toggle back and forth in unison approximately 10 times, then released when the faster blinking starts, the Module will start to reset to factory default settings, which affect the parameters but not the firmware version.

Factory Parameters*

- a. Default device number of 0
- b. NDP mode
- c. Unbound state
- d. No IRL files

IMPORTANT: *If a Module is receiving power from a switcher, disconnect the DXLink connector on the module and reattach to apply power.*

To reset a Module to its factory default settings:

(1) Press and hold the ID Pushbutton while plugging in the power connector. Start counting when the NetLinx LEDs begin to flash in unison, not when the power connector is inserted.

- a. Once the Module has started booting up, both NetLinx LEDs flash in unison at the rate of once per second.
- b. After 10 flashes at that rate, the LEDs will blink in unison at a faster rate.

NOTE: *A press-and-hold of the ID Pushbutton at power up will prevent the Module from attempting to come online until the ID Pushbutton is released. The Module will only attempt to come online if you release the Pushbutton prior to*

the faster blink rate.

- (2) At the point that the blink rate increases, release the ID Pushbutton to enter and start reset to factory default settings mode.
- (3) Reset factory default settings mode will start and the Link and Status LEDs will turn off.
- (4) Once the factory settings are reset, the Link and Status LEDs will return to normal operation.

The Module will automatically reboot to complete the process.

TIP: *In the following procedure – if you start a press and hold sequence with the ID Pushbutton and then decide not to change the settings, before you release the ID Pushbutton remove power from the unit to abort the procedure (remember, power can be applied via the external power supply or over DXLink, so one or both sources of power may need to be removed).*

4. Restore the Factory Firmware Image and Factory Default Parameters

During power up – if the ID Pushbutton is held until the Link and Status LEDs toggle back and forth in unison approximately 30 times (10 slow, 20 fast) and then the LEDs go solid on, after about 10s, the factory firmware image restore action will begin. This procedure affects both the firmware version and the parameters.

IMPORTANT: *If the Module is receiving power from a switcher, disconnect the RJ-45 cable from the DXLink connector on the module before starting the instructions below.*

To restore the Module to its factory default firmware image:

- (1) Press and hold the ID Pushbutton while plugging in the power connector (if the power source is a switcher, plug in the RJ-45 connector into the DXLink port). Start counting when the NetLinX LEDs begin to flash in unison, not when the power connector is inserted.
 - a. Once the Module has started booting up, all LEDs flash in unison at the rate of once per second.
 - b. After 10 flashes at that rate, the LEDs will blink in unison at a faster rate.
 - c. After 10 seconds of flashing at the increased rate, all LEDs go to solid on.
 - d. Release the ID Pushbutton
- (2) Upon the LEDs solid on, the Module executes the following actions:
 - a. Restores itself to its factory firmware image.
 - b. Resets to factory default parameters*:
 - 1) Deletes all IRL files stored on the device.
 - 2) Resets to the default static IP address of 192.168.1.2 and default DHCP address of 169.254.2.2.
 - 3) Resets to the default device number of 0 (when bound to a Central Controller, receives a dynamic device number from the Central Controller).
 - 4) Resets to NDP mode and being unbound.
- (3) Once all actions in Step 2 are completed, the LEDs all turn off, indicating the Module is ready to reboot. The Module automatically reboots to complete the process.

5. Show IP Address (OSD)

The ID Pushbutton can be used to display the LAN IP address of the RX.

To Show the IP address on the display connected to RX:

- (1) Press the ID button twice, the IP address will be shown on the connected display.
- (2) Change the positions the IP address shown via SEND_COMMANDS or WEB UI.

NOTE: *This function only supports showing the public network IP address of RX, when the device is in bypass mode, the function will be disabled.*

6. Access to Field Update Mode

Use a USB drive to upgrade firmware (Including Kernel/APP of ARM, APP of STM32, APP of EP, APP of 6488, APP of DSC module) through the USB (Type-A) port. For details, see “Upgrade the firmware through USB Port” in the FIRMWARE UPGRADE section of this document.

ID Pushbutton Boot States and LED Behavior

To monitor the ID Pushbutton boot state of a module by its LEDs, check both the Link/Act and Status LED columns.

ID Pushbutton Boot and NetLinx LED Behavior		
ID Pushbutton Boot States	Link LED	Status LED
Boot with ID Pushbutton held down	Slow Blink (1Hz)	Slow Blink (1Hz)
ID Pushbutton held down long enough for reset to default parameters	Fast blink (2Hz) until ID Pushbutton is released, then OFF	Fast blink (2Hz) until ID Pushbutton is released, then OFF
ID Pushbutton held down long enough for reset to default firmware image	Solid ON, transitions to OFF once the unit completes writing to flash and is ready to reboot	Solid ON, transitions to OFF once the unit completes writing to flash and is ready to reboot
In Auto ID mode	Normal	Blink (2 Hz)
ID Pushbutton held down long enough to accept new ID	2 blinks, then normal	2 blinks, then normal
After boot: ID Pushbutton held down, but not long enough for IP mode change	Slow blink (1 Hz)	Slow blink (1 Hz)
After boot: ID Pushbutton held down long enough for IP mode change	Fast blink, then OFF	Fast blink, then OFF

RS232 and IR Operations

The RS232 and IR ports have multiple modes according to the three DXLink connection modes.

RS232 Operations

The RS232 (serial) ports are the 3-position screw terminal blocks (see “Pin Information” Section) on the rear of the modules. Serial control has three modes.

1. RS232 Pass Through

Under Extender Mode, the serial data can be passed through to/from DXLink port. Wire these ports to supply serial data along with the associated video and audio signals from a source device (over the twisted pair cable between the Transmitter Module and the Receiver Module) to a destination device or vice versa from the Receiver Module to the Transmitter Module. For more detail, see the “Wiring” part of “Installation and Wiring” section.

IMPORTANT: For serial strings to pass through a standalone TX and RX pair (in Extender Mode) without a NetLinX Central Controller acting as the host, DIP switch #2 Toggle must be set to OFF on each Module.

See the diagram below:

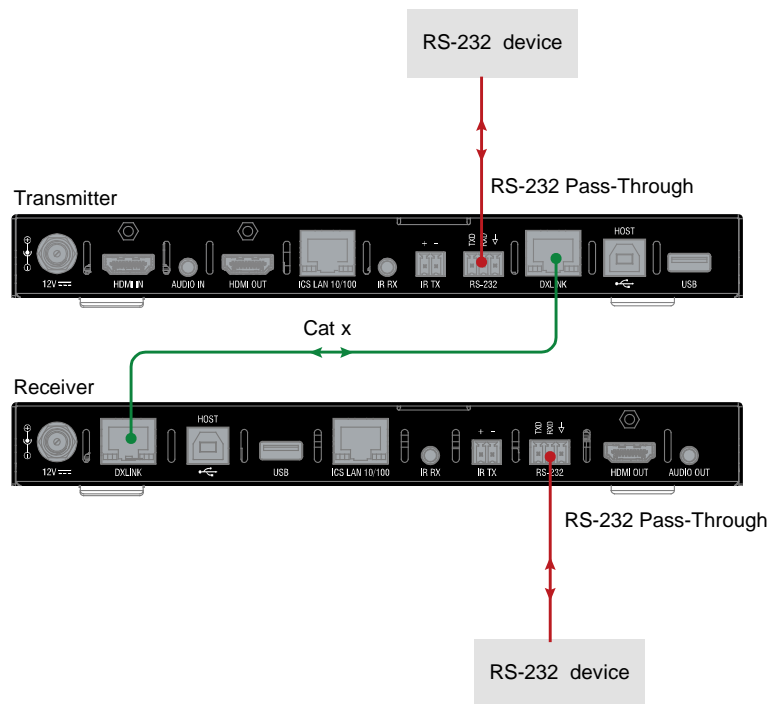

Fig 1: RS232 Pass-Through

2. Local Control

Ensure the #3 DIP Switch is set to “ON” and the Web UI of the transmitter/receiver is enabled. Using the web UI, set the RS232 settings Mode to “Local”. For more detail, see “Web UI Control” Section.

Under Local Mode, the serial port can be configured to send a command based on the presence of a video signal.

3. Online Control

This port can be also be used as an independent native NetLinX control port from a networked NetLinX Central Controller.

In Endpoint Mode (Modules connected to a switcher), serial operations are handled by the host providing control of the endpoints. The Central Controller’s programming specifies where the serial commands are sent (this is handled independently from the routing of the video signals). For additional information on Endpoint Mode, see “Installation and Wiring” section. For Serial SEND_COMMANDs, see “APPENDIX C: ICSP Command” section.

To wire the RS232 (serial) connectors on DXLink Modules for data transfer (see “Fig3: Serial Data Transfer and IR

Flow Control”):

- (1) Wire the RS232 connectors on Modules according to the pinout directly (see “Pin Information” Section) above the connector.
- (2) Use the command to enable this port on Transmitter and Receiver Modules (complete Serial SEND_COMMAND programming information is available on “APPENDIX C: ICSP Commands” section).

IR Operations

The IR ports are the 3.5mm port on the rear panel of the modules.

1. IR Pass-Through

When DX-TX-4K60 and DX-RX-4K60 are connected directly (Extender Mode), connect the IR Receiver to IR RX port of the transmitter/receiver and connect the IR Emitter of the receiver/transmitter. IR Signals can be transmitted from transmitter to receiver or reversed.

See the diagram below:

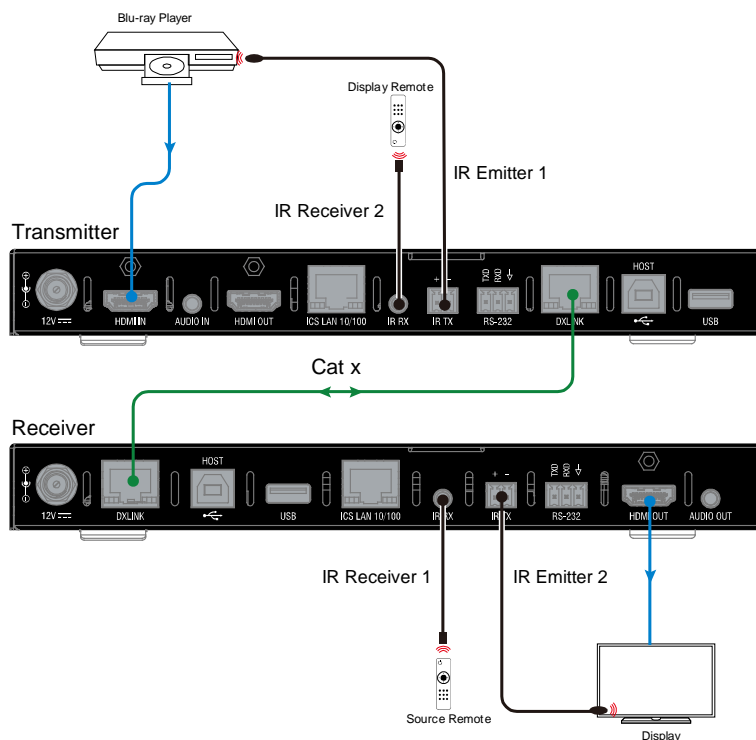

Fig 2: IR Pass-Through

2. Local Control (IR TX port only)

Ensure the #3 DIP Switch is set to “ON” and the Web UI of the transmitter/receiver is enabled. Login web UI, set the IR Control settings Mode to “Local”. More installation information, see “Wiring” part of “Installation and Wiring” Section, and more detail information, see “Web UI Control” Section.

Under Local Mode, the IR TX can be configured with preset commands that will be sent when the video signal status changes.

NOTE: IR Output data can also be configured via IR input data from IR RX port.

3. Online Control

In addition to being directly connected to a device, IR ports can be connected as independent native NetLinX control ports from networked NetLinX Central Controllers.

In Endpoint Mode (Modules connected to a switcher), IR operations are handled by the host providing control of the endpoints. The Central Controller’s programming specifies where the IR commands are sent (this is handled

independently from the routing of the video signals). For additional information on Endpoint Mode, see “*Installation and Wiring*” section. For IR SEND_COMMANDs, see “*APPENDIX C: ICSP Commands*” section.

See the diagram “Serial Data Transfer and IR Flow Control”.

IMPORTANT: *When a Transmitter and Receiver are used as a standalone pair, IR control is passed through directly in Extender Mode, when #2 Toggle is set to OFF (default). When #2 Toggle is set to ON, the Central Controller handles the IR control. When a Transmitter and Receiver are connected to a switcher, they default to Endpoint mode and the integrated Central Controller handles the SEND_COMMANDs.*

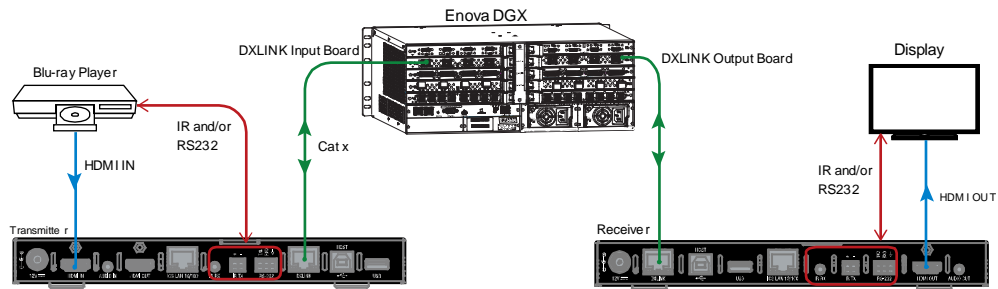

Serial Data Transfer and IR Flow Control

Network Configuration

IMPORTANT: If DXLink Modules are connected to an Enova DGX 100 Series Switcher using auto-setup, see the “Hardware Reference Manual – Enova DGX 100 Series Digital Media Switchers” for network configuration information.

NOTE: If a DXLink Module has been configured for auto-setup mode and then auto-setup mode has been disabled in the switcher, the unit may take longer to appear in NetLinx Studio than expected (1-2 minutes).

DXLink Modules support two IP Addressing Modes: Static IP and DHCP (with link-local fallback).

To avoid having a large system consume numerous IP addresses, Modules default to disabling the network connection functionality.

Therefore, the #3 Toggle must be set to ON before the Module can establish a network connection (see “DIP Switch Function” section).

When #3 Toggle is ON, DXLink Modules are automatically placed in DHCP Mode, but they can be configured for either of the IP Addressing Modes via two methods:

- The front-panel ID Pushbutton (see “ID Pushbutton Operation” section)
- Telnet commands (see “APPENDIX B: Telnet Commands” section)

“Link-local fallback” is a method by which an IP host, as a fallback from DHCP, can derive a local network-unique IP address by negotiating with the other IP hosts on the same network. Link-local can also be used as the primary method of IP address allocation. For details, see “DHCP Mode” below.

Static IP Mode – Default Parameters

IMPORTANT: Static IP Mode will not function until the #3 Toggle on the DIP switch is set to ON (see “DIP Switch Function” section). The #3 Toggle must be ON before the device is accessible via web UI or SEND_COMMANDs.

Default IP Parameters for Static IP Mode	
Address	192.168.1.2
Netmask	255.255.255.0
Gateway	192.168.1.1
DNS1	8.8.8.8
DNS2	8.8.8.8
DNS Domain	amx.com

DHCP Mode

IMPORTANT: DHCP Mode will not function until the #3 Toggle on the DIP switch is set to ON (see “DIP Switch Functions” section). The #3 Toggle must be ON before the device is accessible via web UI or SEND_COMMANDs.

DHCP Mode requires a connection to a network with a DHCP server located on it. This connection can be either indirect or direct.

- Indirect connection – In the case of an Enova DGX Digital Media Switcher or a Solecis 4K Digital Switcher (Endpoint Mode) that is connected to a DHCP server device, the DHCP connection can be propagated through the system’s DXLink layer.
- Direct connection – In the case of a standalone pair (Extender Mode), to place a DXLink Module in DHCP Mode you must complete the following:
 1. Set the #1 Toggle to ON to enable access to the physical ICS LAN 10/100 port.
 2. Set the #3 Toggle to ON to enable network connectivity (DHCP).
 3. Connect the ICS LAN 10/100 port to a network where a DHCP server is located.

When in DHCP Mode (default setting), the Module will attempt to get a DHCP lease (consisting of IP address, gateway,

and other network parameters). Should the attempt fail, the Module will then configure itself for a link-local address.

- DXLink Modules utilize a modified link-local addressing procedure. The first address to be tried is a known address in the link-local space: 169.254.2.2. That address will be probed, and if unclaimed will be used by the DXLink Module.
- If 169.254.2.2 is already claimed, the DXLink Module will choose a random address within the 169.254.x.x link-local address space (again probing to ensure that it is unclaimed).

A Module operating with a link-local address will periodically re-try DHCP and re-assign the IP to a valid DHCP grant if successful. At any time, if the Module determines that its IP address has changed, it will disconnect from the Central Controller (if necessary, depending on the connection state) and then reconnect to the Central Controller.

TCP/IP Address Configuration

DXLink Modules support IPv4 network addresses, gateway addresses, DNS server addresses, and network names. They also support NDP (NetLinx Discovery Protocol) capabilities as well as IP discovery via NetLinx Studio.

NOTE: *NDP is a device discovery method used by NetLinx Central Controllers. With NDP Beacon enabled, the Central Controller will transmit NDP Beacons for AMX's proprietary device discovery.*

Telnet IP Configuration Commands

The SET IP and GET IP Telnet commands listed in the tables in Appendix B can be sent directly to the Module via a Telnet terminal session. These commands can be used for initial network configuration of DXLink Modules.

- The default Telnet port is 23.
- Telnet is enabled by default.
- A value of 0 disables the telnet server. *

For details, see “*Appendix B: Telnet Commands*” section.

* If you set the Telnet port to “0” to disable it, you will need to perform a factory reset using the ID Pushbutton to re-enable it (see “*ID Pushbutton Operation*” section).

Offline Recovery Mechanism

Offline Recovery Mechanism – A recovery mechanism for DXLink Modules in the rare occurrence that these units move from online to offline status for an extended period of time.

The recovery mechanism monitors the ICSP connection between the DXLink Module and the Central Controller and is not armed until the Module is brought online. Entering an offline state triggers an internal timer in the Module which, after 5 continuous minutes in the offline state, triggers the recovery mechanism to issue a full reboot command to the Module. During this time the Module reboots and all functions (including video and audio delivery) are disabled while the reboot occurs. This process takes up to 45 seconds to complete.

This functionality is intended to be a safety net for the rare occasions when a Module falls offline and remains there for a long enough period of time that the likelihood of the Module coming back online on its own diminishes. The reboot is intended to restart the Module and allow it another opportunity to connect with the Central Controller it is bound to. Once a Module reboots, the recovery mechanism will not become armed again until the Module reaches an online state with a Central Controller. Although highly unlikely, the recovery mechanism also monitors the Module's processor and provides a self-recovery mechanism if the device enters an unstable processing condition.

NetLinx Programing

Advanced users may also choose to control the DX-TX/RX-4K60 through NetLinx Studio via the ICS LAN 10/100 port on endpoint mode (standalone mode). Or connect the devices to DGX or DVX switcher in endpoint mode (switcher).

NOTE: For additional information on using NetLinx Studio, refer to the *WebConsole & Programming Guide – NX-Series Controllers* (available at www.amx.com).

Device Numbering and Ports

Each DXLink Module has its own Device Number (which is assigned when the unit is bound to a Central Controller) and the following ports.

Transmitter:

Port 1: RS232

Port 2: Not Used

Port 3: IR TX

Port 4: IR RX

Port 5: USB Device, USB Host

Port 6: DXLINK OUT

Port 7: HDMI IN, Audio IN

Port 8: Not Used

Port 9: HDMI OUT

Port 10: ICS LAN 10/100

Receiver:

Port 1: RS232

Port 2: Not Used

Port 3: IR TX

Port 4: IR RX

Port 5: USB Device, USB Host

Port 6: HDMI OUT, Audio OUT

Port 7: DXLINK IN

Port 8: Not Used

Port 9: Not Used

Port 10: ICS LAN 10/100

IMPORTANT: Best practices for using `SEND_COMMANDS` with DXLink endpoints include sending commands to the specific input or output port of the Enova DGX switcher (i.e., 5002:4:0 for input/output channel 4). For a complete list of NetLinx Programming Commands, Channels, Levels, and Port mapping see the “Enova DGX 100 Series Digital Media Switchers Hardware Reference Manual” at www.amx.com.

NetLinx Control in Endpoint Mode (Switcher)

NOTE: Before the connection with DGX/DVX switcher, ensure the #3 DIP switch is set to the “ON” (See “DIP Switch Function” section). Auto-setup information (which does not require binding) is available in the *Hardware Reference Manual – Enova DGX 100 Series Digital Media Switchers*.

The following picture is an example to show the device number and ports when the receiver is connected with a DGX Switcher. More information about installation information, see “Wiring” part of “Installation and Wiring” section.

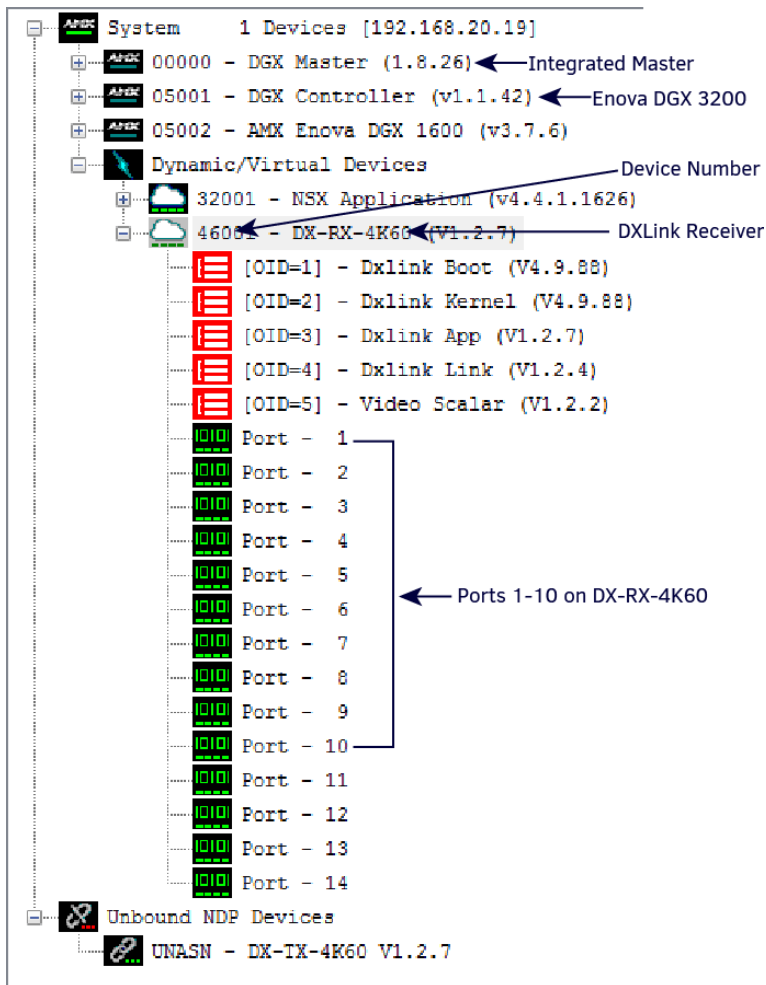

Send Commands to control a device

Click **"Diagnostics"** on the menu bar, choose **"Control a Device"**. A window will display as follows, enter the device number, Port number, and System number in Device, Port, System boxes according to the previous section, and enter a command in the textbox, and click **"Send To Device"**. (ICSP command list is available in the "APPENDIX C: ICSP Commands" section.)

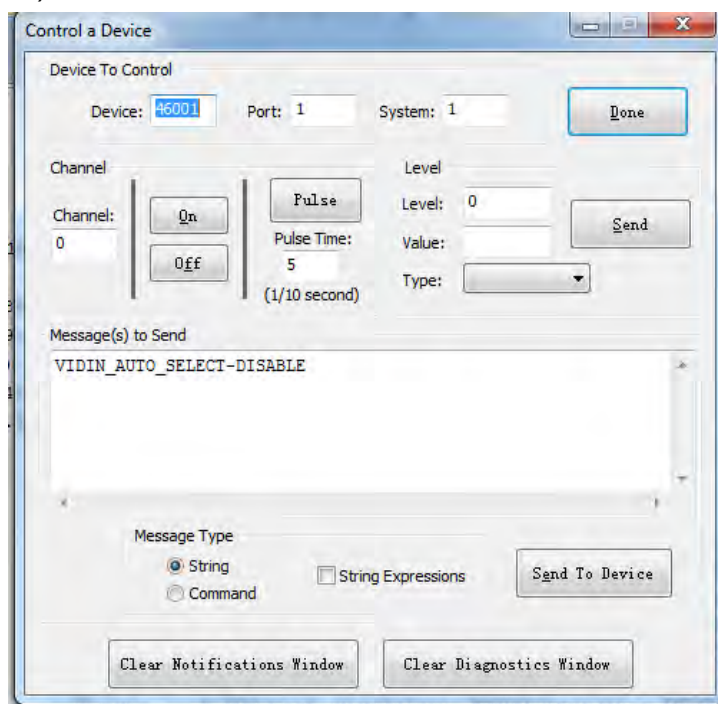

Telnet Control

1. Choose the device you want to control, right click, then choose “**TELNET Window**”->“**Launch TELNET window via NetLinx Studio**”, enter the telnet window, input telnet commands in this window to control the device.

NOTE: More Commands, please refer to “**APPENDIX B: Telnet Commands**” section.

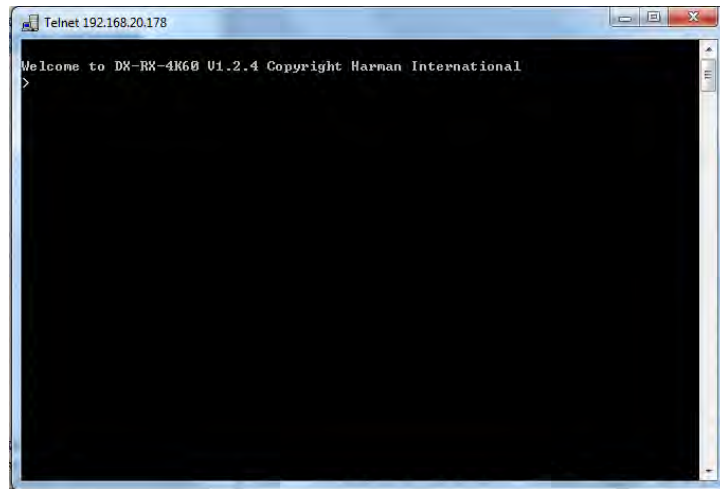

At the prompt (>), type the Telnet command and press Enter.

If you select “**Launch TELNET Window via User Defined Program**”, you may need to enable Telnet by completing the following:

- 1) Go to Start/Control Panel/Programs and Features;
- 2) On the left, select “**Turn Windows features on or off**”;
- 3) Select the check-boxes Telnet Client and Telnet Server and click “**OK**”.

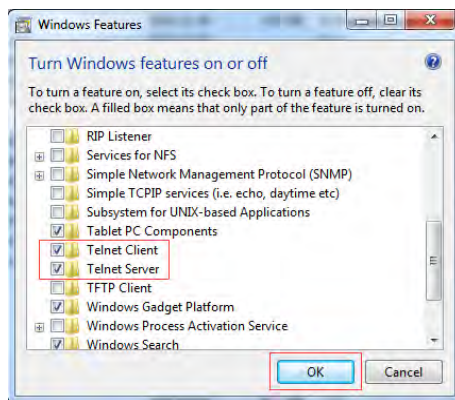

NetLinx Control in Endpoint Mode (Standalone)

NOTE: Before the connection of ICS LAN 10/100 port, ensure #1 DIP Switch is set to “ON” (See “**DIP Switch Function**” section).

The following picture is an example to show the device number and ports when the transmitter and receiver are connected in Endpoint Mode (Standalone) mode.

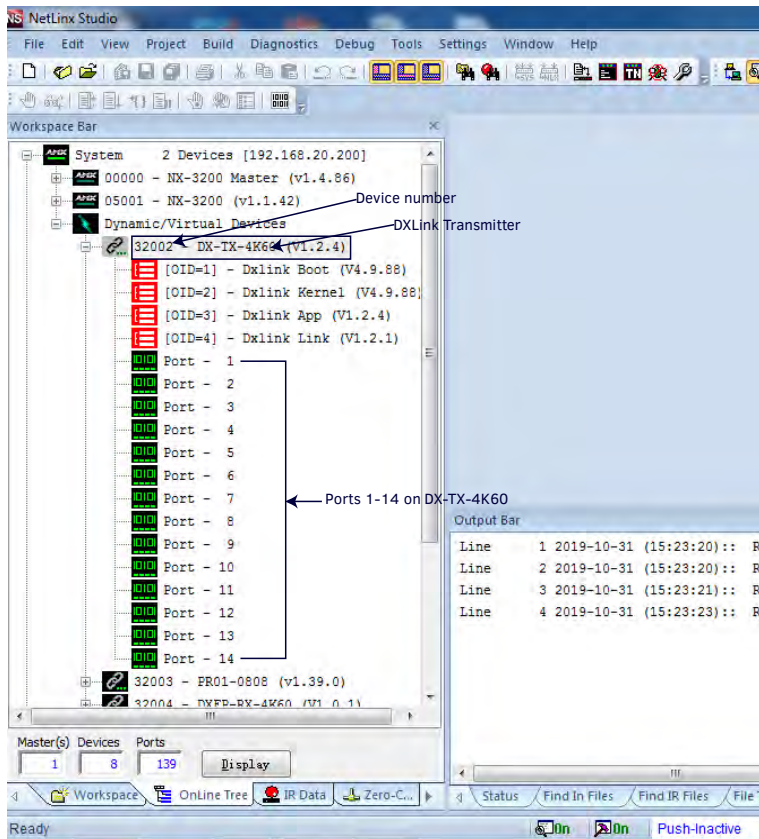

Get detail information about installation, see “Wiring” part of “Installation and Wiring” Section.

Launch NetLinx Studio and open the Online Tree.

Bind the target device to the integrated Central Controller: select and right-click the DX-TX-4K60/DX-RX-4K60: from the context sensitive menu, select “Network Bind/Unbind Device” (be sure the check box is selected), click “OK”.

Send Commands to Control a Device

Click “Diagnostics” on the menu bar, choose “Control a Device”.

A window will display as follows, enter the device number, Port number, and System number in Device, Port, System boxes according to the previous section, and enter a command in the textbox, and click “Send To Device”. (ICSP command list is available in the “APPENDIX C: ICSP Commands” section.)

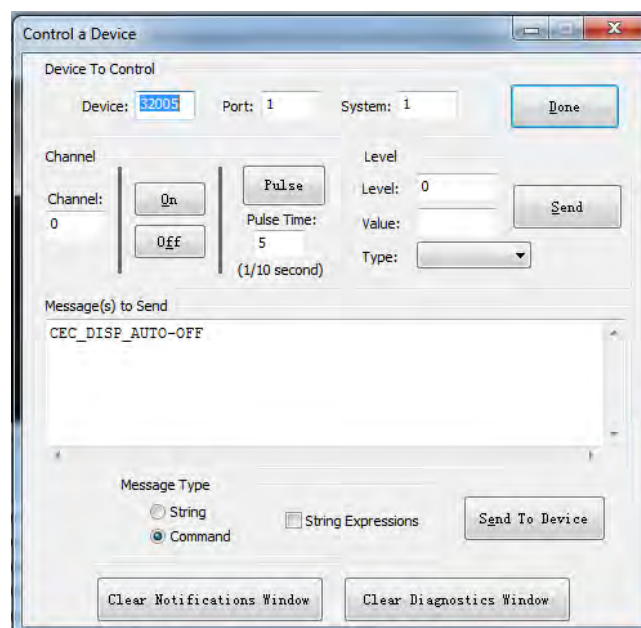

Telnet Control

1. Choose the device you want to control, right click, then choose “**TELNET Window**”->“**Launch TELNET window via NetLinx Studio**”, enter the telnet window, input telnet command in this window to control the device.

NOTE: More Commands, please refer to “**APPENDIX B: Telnet Commands**” section.

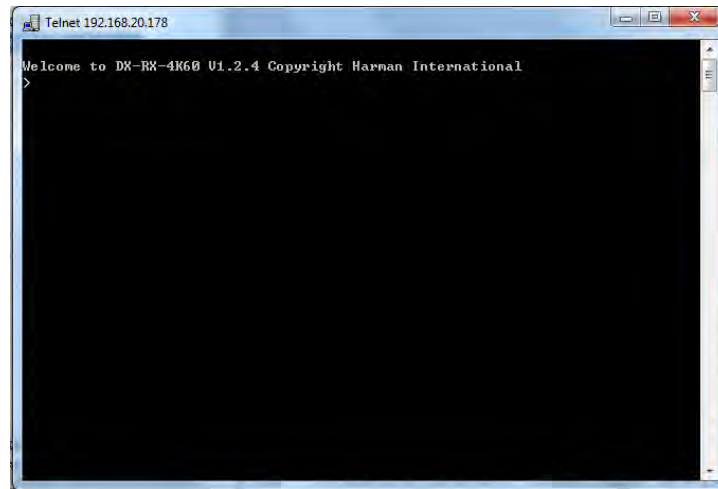

1. At the prompt (>), type the Telnet command and press Enter.

If you select “**Launch TELNET Window via User Defined Program**”, you may need to enable Telnet by completing the following:

- 4) Go to Start/Control Panel/Programs and Features;
- 5) On the left, select “**Turn Windows features on or off**”;
- 6) Select the check-boxes Telnet Client and Telnet Server, and click “**OK**”.

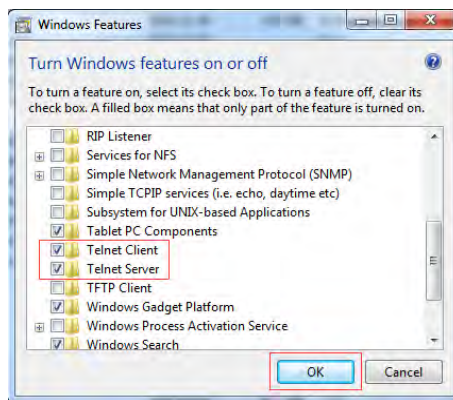

Web UI Control

When the devices are used in endpoint mode (standalone), choose the device you want to control, right click, then choose “**Web Control Page**”-> “**Launch Web Control Page via NetLinx Studio/Launch Web Control Page via Default Browser**”, enter the Web UI Control Page.

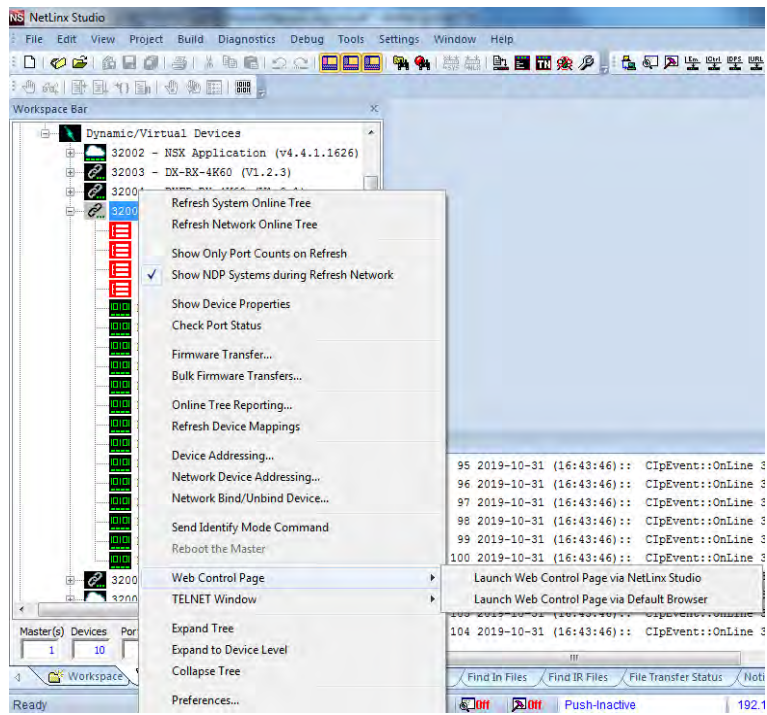

Web UI Control

The Web UIs designed for the DX-TX-4K60 and DX-RX-4K60 allow basic controls and advanced settings of the device. The Web UI page can be accessed through NetLinx Studio or through a browser with latest version, e.g. Chrome, Firefox, Safari, Opera, Edge, etc.

Preparations before Logging into Web UI

Before connection:

- Ensure #1 and #3 of DIP Switch are set to ON.
- Ensure NetLinx Studio 4.0 or later is installed on the PC.

Steps to log in to web UI pages:

1. Connect the ICS LAN 10/100 port of transmitter/receiver to the local area network. Connect the PC to the same network of the device.
2. Power on all devices, launch NetLinx, and open Online tree (See “*NetLinx Programming*” section).

NOTE: When the transmitter and receiver are connected with a DGX or DVX switcher, the Web UIs of transmitter and receiver are limited. Enter the web UI of the DGX or DVX switcher to control them.

Get IP Address

Within the NetLinx Studio Online Tree, right click on the device ID and select **Show Device Properties**.

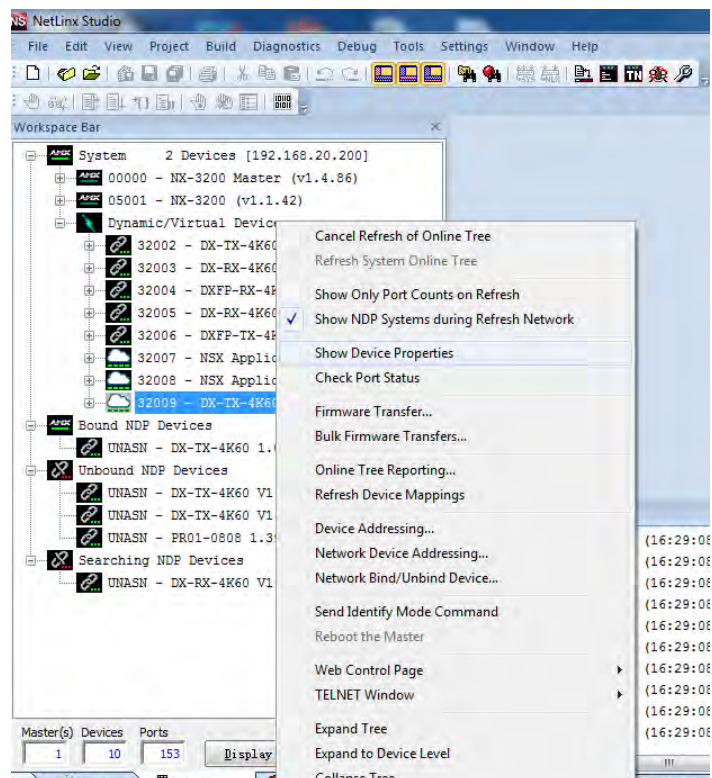

Steps to get IP address through receiver OSD function:

- (1) Connect the receiver as explained in the “*Installation and Wiring*” section. Connect a display to the HDMI OUT port of the receiver.
- (2) Power on all devices. Press the ID button on Receiver for twice continuously, the IP address will be displayed on the display connected.

NOTE: When the receiver is in bypass mode, the OSD function is disabled.

Web UI of DX-TX-4K60

DX-TX-4K60



The screenshot shows a login page with a black header bar containing the text "Login". Below the header is a white form with a "Password" label and a text input field. A "Login" button with a right-pointing arrow is located at the bottom right of the form.

Input the password then Login to enter the following page. The default password is “**admin**”.

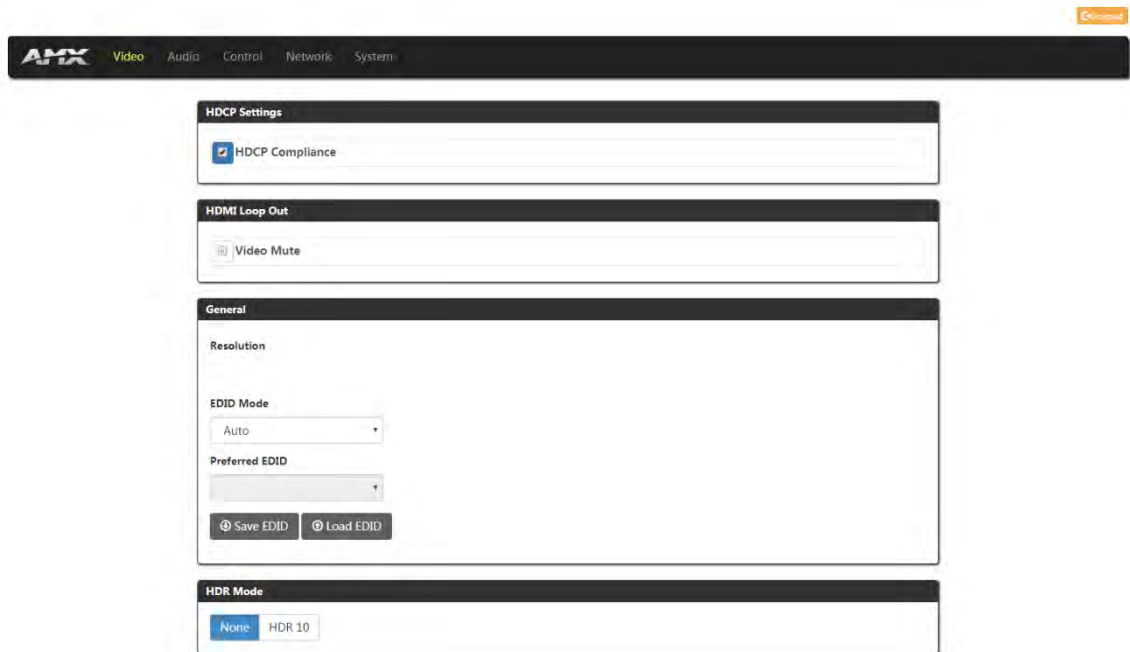

The screenshot shows the main web UI with a black header bar containing the "AMX" logo and navigation links: "Video", "Audio", "Control", "Network", and "System". A "Logout" icon is in the top right corner. The main content area is divided into four sections: "HDCP Settings" with a checked "HDCP Compliance" checkbox; "HDMI Loop Out" with a "Video Mute" checkbox; "General" with "Resolution" and "EDID Mode" (set to "Auto") dropdowns, a "Preferred EDID" dropdown, and "Save EDID" and "Load EDID" buttons; and "HDR Mode" with "None" and "HDR 10" radio buttons.

The main page includes five submenus: Video, Audio, Control, Network, and System.

Web Introduction

Logout

Click the  icon to return to the login page.

Video

(1) HDCP Settings



The screenshot shows the "HDCP Settings" section with a checked "HDCP Compliance" checkbox.

Set HDCP Compliance enable or disable.

The default setting is enabled.

(2) HDMI Loop Out



Click to set HDMI Loop Out video mute/unmute.
The default setting is Unmute.

(3) General



This section shows the current EDID, and allows you select EDID Mode, Preferred EDID, Save EDID and Load EDID.

- **Resolution:** Shows the resolution of current input signal.
- **EDID Mode:** Click to select the EDID mode from the drop-down menu. The default setting is Auto.

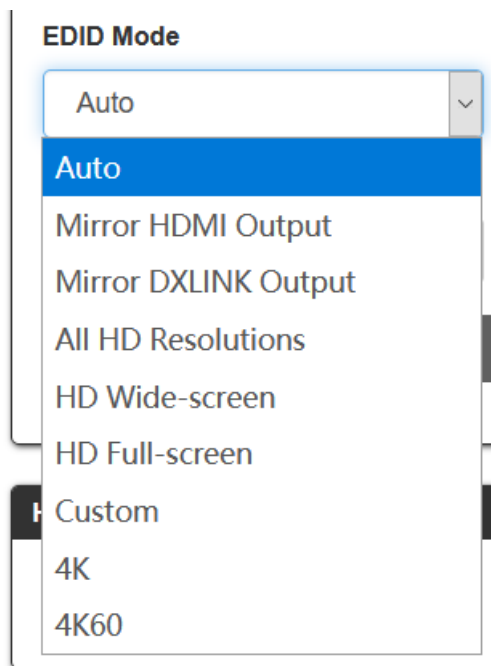

- **Preferred EDID:** When set EDID Mode to a mode except Auto, Mirror HDMI Output, Mirror DXLINK Output and Custom, select preferred EDID from the drop-down menu.
- **Save EDID:** Save the current EDID as a bin file to local PC.
- **Load EDID:** Load saved EDID bin file.

(4) HDR Mode



This section allows you to select HDR mode to HDR 10 or None.

The default setting is None.

Audio



This Section allows you to set Audio Priority auto or manual, Audio Source selection, and set Audio format.

- **Audio Priority:** Set Audio Priority to Auto/Manual. The default setting is Auto.
- **Audio Source:** Select Audio Source manually from HDMI and Analog. The default setting is HDMI.
- **Audio Format:** Select audio format from the drop-down menu. The default format is Basic.

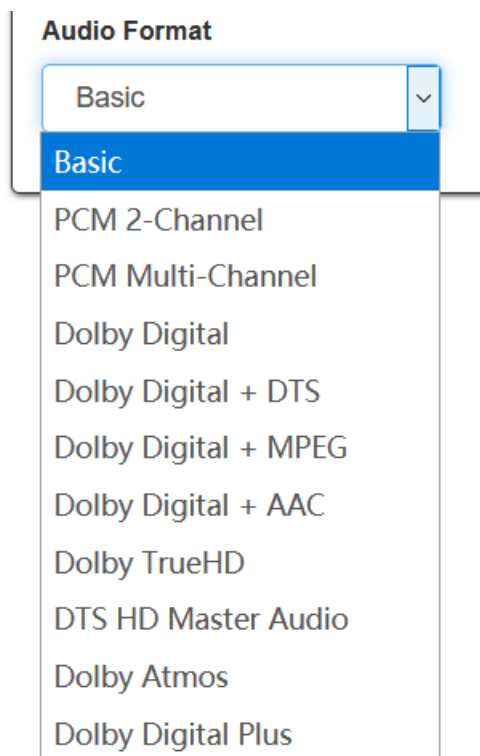

NOTE: When set to Audio Priority is set to Auto, the audio source will be switched between HDMI and Analog based on the presence of an analog audio signal.

Control

DXLINK Mode

Endpoint Extender

CEC Settings

Mode
Netlink Local Passthrough

Output Port
HDMI DXLINK

Manual Power On/Off
ON OFF

Auto Power On/Off
ON OFF

Delay Time (min)

RS232 Settings

Mode
Netlink Local Passthrough

Manual Power On/Off
ON OFF

Baud Rate
115200

Parity Bits
NONE

Data Bits
8

Stop Bits
1 **Apply**

Auto Power On/Off
ON OFF

Delay Time (min)

End Flag
None \r \n \r\n

Power On
 Save

Power Off
 Save

IR Settings

Note: IR Learning Steps under Local Mode
1. IR Receiver Cable to IR RX port.
2. Press "Power On" or "Power Off" button on remote controller.
3. Press "Learn" ICON on the WebGUI setting the given IR code for IR auto control.

Mode
Netlink Local Passthrough

Manual Power On/Off
ON OFF

Auto Power On/Off
ON OFF

Delay Time (min)

Power On
 Learn **Save**

Power Off
 Learn **Save**

This section includes DXLINK Modes, CEC Setting, RS232 Setting, IR Settings parts.

(1) DXLINK Mode



- **Endpoint:** Click to set the device to Endpoint mode.
- **Extender:** Click to set the device to Extender Mode.

NOTE:

- *When the device is in Endpoint Mode, the CEC, RS232 and IR Settings are in NetLinx mode and can't be set through Web UI.*
- *When setting DXLINK Mode through the Web UI, the DIP Switch setting is ignored.*

(2) CEC Setting

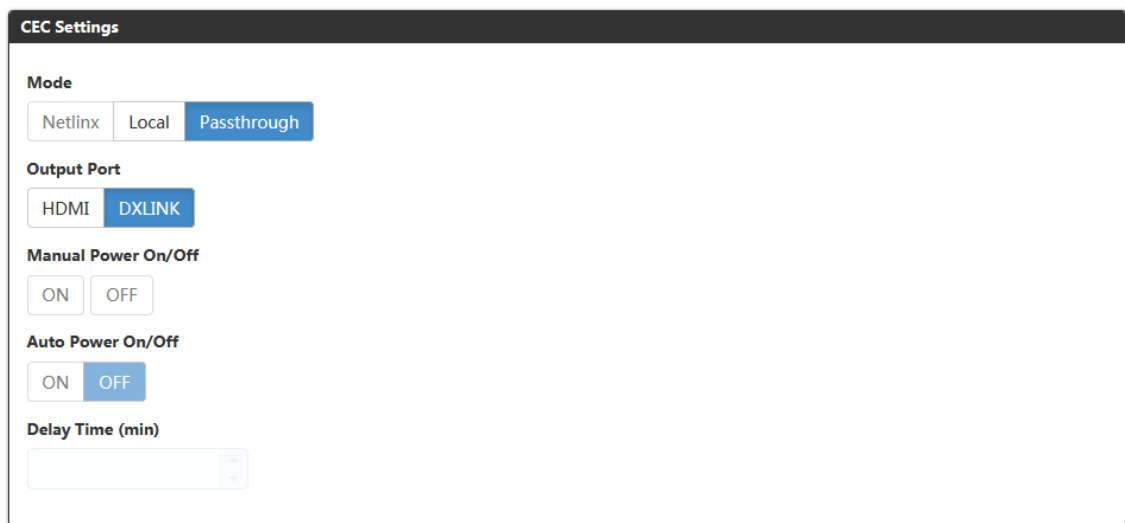

This section is used to set CEC settings parameters.

- **Mode:** Select CEC mode. When the endpoint is set to Extender mode, the default CEC Mode is Passthrough. In passthrough mode, all CEC commands are passed through between source and sink.

When set to Local mode, the following items can be configured:

- **Output Port:** Select whether to send CEC commands to the local HDMI output on the TX or to the DXLink output port. When set to Local mode, the default setting is HDMI.
- **Manual Power On/Off:** Send power on/off command to the selected port manually.
- **Auto Power On/Off:** Click to select Auto control ON/OFF. The default setting is ON.
- **Delay Time (min):** When Auto Power On/Off is set to ON, Choose Auto Control time to set display auto power off time. For example, if the time is set to 2 minutes, when the output has no signal for more than 2 minutes, the display will power off automatically. If you click the button "OFF", the auto power function is disabled.

(3) RS232 Setting

RS232 Settings

Mode
Netlinx Local **Passthrough**

Manual Power On/Off
ON OFF

Auto Power On/Off
ON **OFF**

Delay Time (min)
[Input field]

Baud Rate
115200

Parity Bits
NONE

Data Bits
8

Stop Bits
1 **Apply**

End Flag
None \r \n \r\n

Power On
[Input field] **Save**

Power Off
[Input field] **Save**

- **Mode:** Select RS232 control mode. When the endpoint is set to Extender mode, the default setting is Passthrough. In passthrough mode, all RS232 signals pass through between the RS232 transmitter and receiver.

When set to Local mode the following items can be configured:

- **Manual Power On/Off:** After set the commands of Power On/Off, click ON/OFF to send the commands to the third-party device.
- **Auto Power On/Off:** Set Auto Power On/Off. The default setting is ON.
- **Delay Time:** When Auto Power On/Off is set to ON, Choose Auto Control time to send power off command time. For example, if the time is set to 2 minutes, when the output has no signal for more than 2 minutes, the device will power off automatically. If you click the button “OFF”, this function is free. The default setting is 2min.
- **Baud Rate:** Click the down arrow to select the baud rate. The default setting is 115200.
- **Parity Bits:** Click the down arrow to select the parity bits. The default setting is NONE.
- **Data Bits:** Click the down arrow to select the data bits. The default setting is 8 bits.
- **Stop Bits:** Click the down arrow to select the stop bits. The default setting is 1 bit.
- **Apply:** Click to take effect.
- **End Flag:** Select the ending flag after each RS232 command. The default setting is \n.
- **Power On:** Enter the RS232 command to turn on the projector and screen, then click “Save” button to take effect.
- **Power Off:** Enter the RS232 command to turn off the projector and screen, then click “Save” button to take effect.

(4) IR Setting

IR Settings

Note: IR Learning Steps under Local Mode

1. IR Receiver Cable to IR RX port.
2. Press "Power On" or "Power Off" button on remote controller.
3. Press "Learn" ICON on the WebGUI setting the given IR code for IR auto control.

Mode

Netlinx Local **Passthrough**

Manual Power On/Off

ON OFF

Auto Power On/Off

ON **OFF**

Delay Time (min)

Power On

Learn Save

Power Off

Learn Save

When the DXLINK Mode is set to Extender Mode:

- **Mode:** Select IR control mode. The default setting is Passthrough. In Passthrough mode IR signals are passed through from IR transmitter to IR receiver.

When the mode is set to Local, the following items can be configured:

- **Manual Power On/Off:** After setting Power On/Off commands and finish IR learning, click to turn on/off the third-party device manually.
- **Auto Power On/Off:** Set Auto Power On/Off, the default setting is ON.
- **Delay Time: (min):** When Auto Power On/Off is set to ON, Choose Auto Control time to send power off command time. For example, if the time is set to 2 minutes, when the output has no signal for more than 2 minutes, the device will power off automatically. If you click the button "OFF", this function is free. The default setting is 2min.
- **Power On:** Enter the IR command to turn on the third-party device.
- **Power Off:** Enter the IR command to turn off the third-party device.

Note: *IR Learning Steps under Local Mode:*

1. Connect an IR Receiver cable to the IR RX port.
2. Press the "Learn" button for the respective command to temporarily store the IR command.
3. Press the "Power On" or "Power Off" button on the remote control for the device.
4. Click "Save".

Network

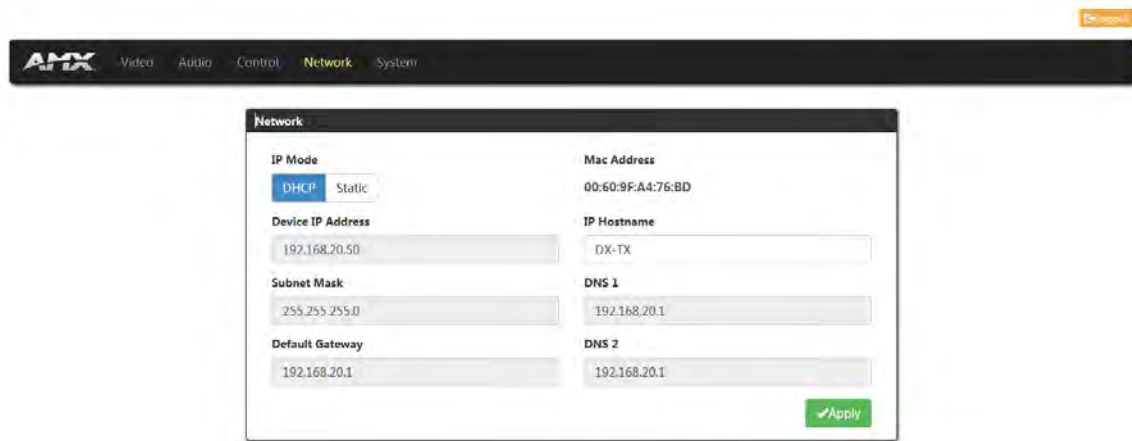

The screenshot shows the Network configuration page in the AMX web interface. The top navigation bar includes 'AMX', 'Video', 'Audio', 'Control', 'Network', and 'System'. The 'Network' section is active. The configuration form is titled 'Network' and contains the following fields:

Field	Value
IP Mode	DHCP (selected), Static
Mac Address	00:60:9F:A4:76:BD
Device IP Address	192.168.20.50
Subnet Mask	255.255.255.0
Default Gateway	192.168.20.1
IP Hostname	DX-TX
DNS 1	192.168.20.1
DNS 2	192.168.20.1

An 'Apply' button is located at the bottom right of the form.

This Section allows you to set Network.

- **IP Mode:**
 - a) **DHCP:** When enabled, the IP address will be assigned automatically by the DHCP server connected.
 - b) **Static:** When enabled, set up the IP address manually.
- **Mac Address:** Show mac address of the device.
- **Apply:** Click “Apply” to take effect.

The default IP Mode is DHCP.

System

The screenshot displays the AMX System configuration interface. At the top, there is a navigation bar with 'AMX' and tabs for 'Video', 'Audio', 'Control', 'Network', and 'System'. The 'System' tab is active. Below the navigation bar, there are ten submenus arranged in a grid:

- Firmware Version:** Lists firmware versions: ARM_V1.5.3.1, STM32_V1.4.10, EP_V4.3, VALENS_V7.4.44, and SI9396_V1.3.2.
- ICSIP Parameter:** Includes fields for Connection Mode (NDP), Master URL (00:60:5f:a4:12:ae), System Number (1), and Device Number (32003). An 'Apply' button is at the bottom right.
- DIP State:** Shows a red 'ON' indicator and four DIP switches labeled 1, 2, 3, and 4.
- USB State:** Features 'Host' and 'Device' toggle buttons.
- SSH Account:** Includes an 'Access' toggle (ON/OFF), and input fields for Username and Password. An 'Apply' button is at the bottom right.
- Telnet Account:** Similar to SSH Account, with 'Access' toggle and Username/Password fields. An 'Apply' button is at the bottom right.
- Upload Certificate:** Contains 'Load File' buttons for Private Key (.pem) and Certificate (.pem), and a Password field. An 'Apply' button is at the bottom right.
- Login Password:** Includes input fields for Old Password, New Password, and Confirm Password. An 'Apply' button is at the bottom right.
- Device Configuration:** Features 'Save Config' and 'Load Config' buttons.
- System:** Includes 'Reboot', 'Factory Default', and 'Update Info' buttons.

This section includes ten submenus to get system status and configure system items.

(1) Firmware Version

The screenshot shows the 'Firmware Version' submenu with the following text:

```
ARM_V1.5.3.1
STM32_V1.4.10
EP_V4.3
VALENS_V7.4.44
SI9396_V1.3.2
```

This section shows the firmware version of the device.

(2) ICSP Parameter

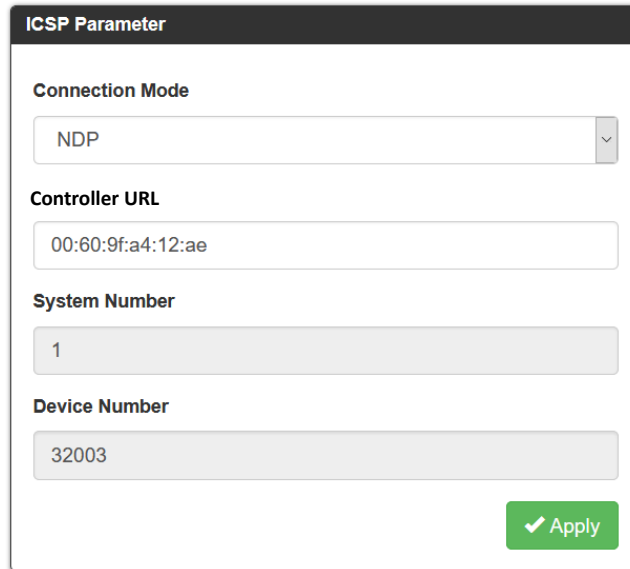

The screenshot shows a configuration window titled "ICSP Parameter". It contains the following fields:

- Connection Mode:** A dropdown menu with "NDP" selected.
- Controller URL:** A text input field containing "00:60:9f:a4:12:ae".
- System Number:** A text input field containing "1".
- Device Number:** A text input field containing "32003".

An "Apply" button with a checkmark icon is located at the bottom right of the window.

In this column, users can set ICSP parameters.

- **Connection Mode:** Includes four options of NDP, Auto IP, URL/TCP, URL/UDP. The default setting is NDP.
- **Controller URL:** Input the connected Central Controller's URL.
- **System Number:** Use the Online Tree to determine it. By default, it is disabled to configure.
- **Device Number:** Use the Online Tree to determine it. By default, it is disabled to configure.
- **Apply:** Click "Apply" to make the settings take effect.

(3) DIP State



Show the current DIP Switch status.

(4) USB State



Show the current USB slide switch position.

(5) SSH Account

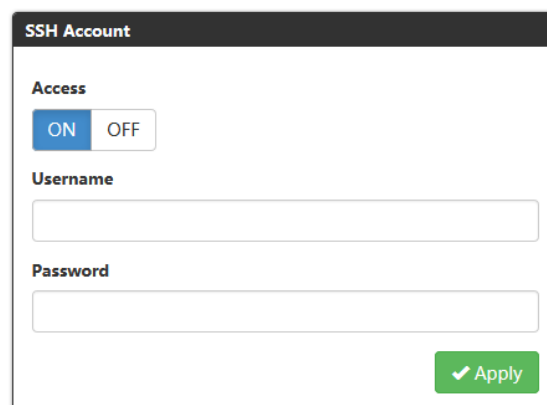

The screenshot shows a configuration window titled "SSH Account". It contains the following fields:

- Access:** A toggle switch with "ON" selected.
- Username:** A text input field.
- Password:** A text input field.

An "Apply" button with a checkmark icon is located at the bottom right of the window.

SSH Account is used to configure the SSH connection on/off, username and password of the account. For SSH Account, the default username is **admin**, the default password is **password**.

- **Apply:** Click to perform the settings. It will perform reboot the device to take effect.

(6) Telnet Account

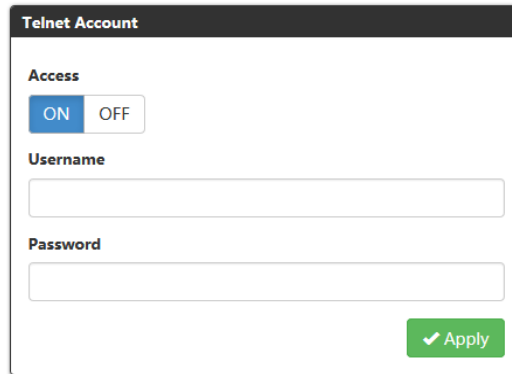

Telnet Account is used to configure Telnet connection, Username and Password of the account. For Telnet Account, the default username and password are null.

- **Apply:** Click to perform the settings. It will perform reboot the device to take effect.

(7) Upload Certificate

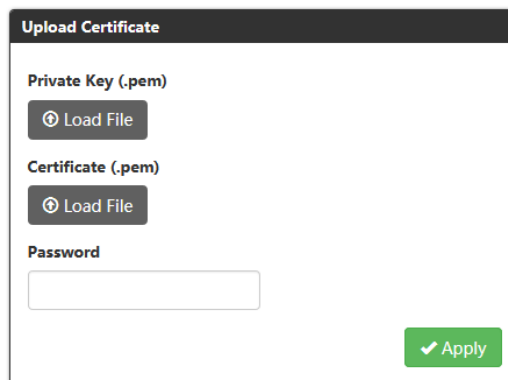

This section allows you to upload HTTPS Private and Certificate.

- **Apply:** Click Apply to take effect.
- **Password:** Input the password of the certificate loaded.

NOTE: Please reboot the device for setting changes to take effect.

(8) Login Password

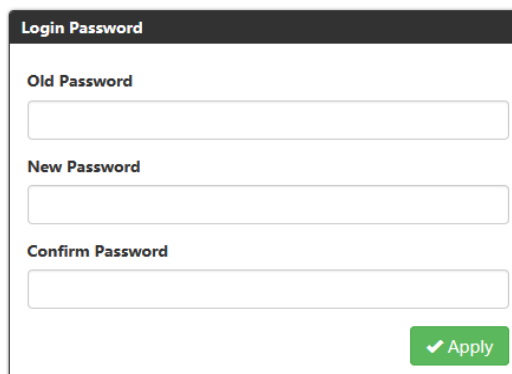

This Section allows you to change login password. The default password is "admin".

- **Apply:** Click “Apply”, it will perform to reboot the device to take effect.

(9) Device Configuration

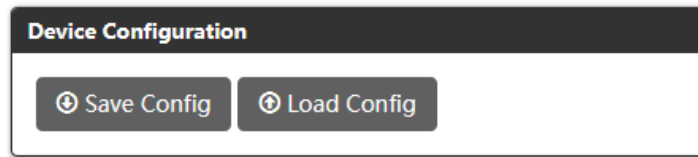

- **Save Config:** Click to save the current configuration as a bin file to local PC.
- **Load Config:** Click to load the saved configuration bin file.

(10) System

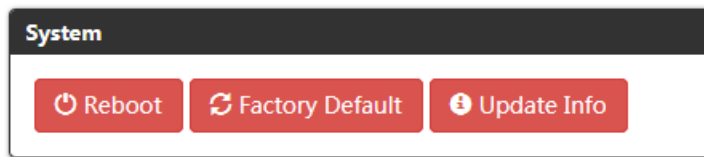

This section allows you to reboot the device, set the device to factory and check the Update Information.

- **Reboot:** Click to Reboot to reboot the device. Wait about 2-3 minutes to refresh the web page.

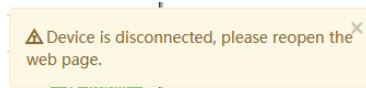

- **Factory Default:** Click “Factory Default” to reset the device to factory settings. Wait about 2-3 minutes to refresh the web page.
- **Update Info:** Clicking “Update Info” will direct you to a page that displays the Upgrade process status.

Update Status

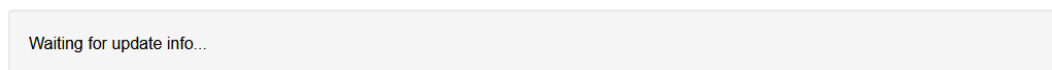

Web UI of DX-RX-4K60

DX-RX-4K60

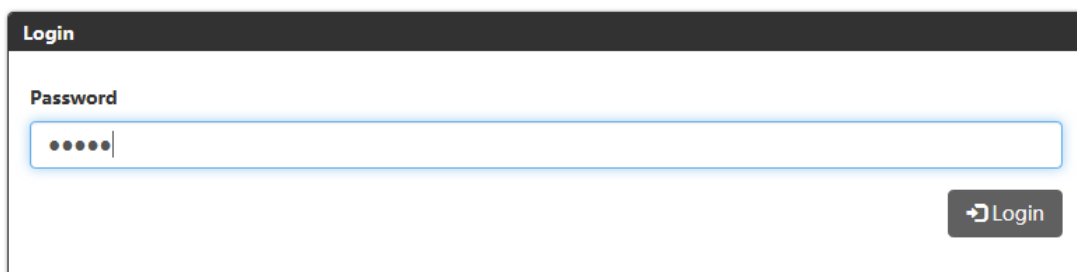

Input the password and click Login to enter the main page. The default password is “**admin**”.

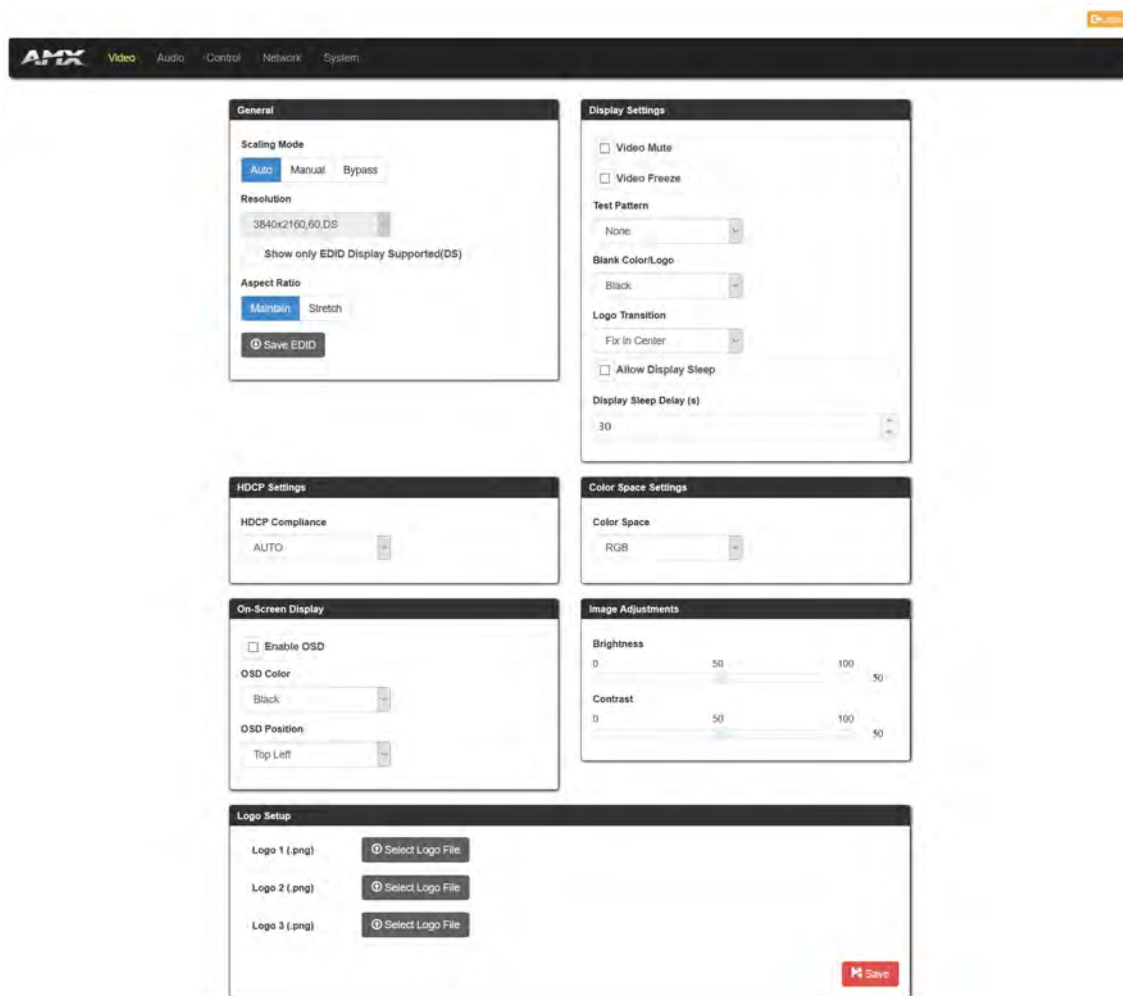

Web UI Introduction

Video

(1) General

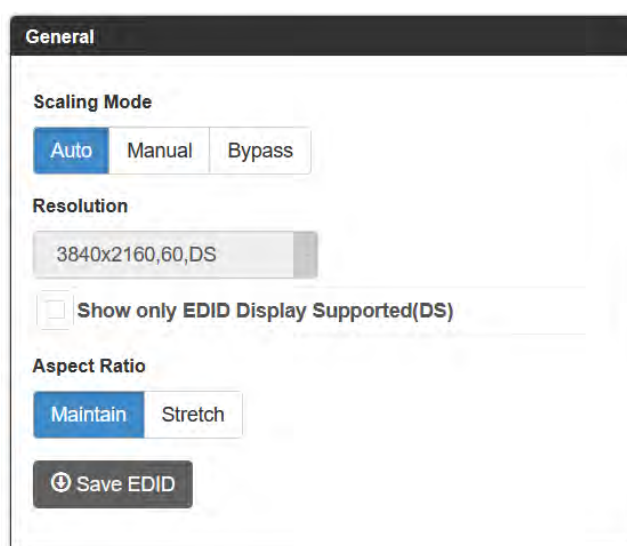

- **Scaling Mode:** Select Scaling mode. The default setting is Auto.
- **Auto:** Auto Mode will configure the scaler settings based on EDID information received from the connected display.
- **Manual:** Manual Mode allows the user to configure the output resolution of the video that will be transmitted

to the destination device.

- **Bypass Mode:** Bypass Mode enables the receiver to pass video without alteration by the internal scaler.
- **Resolution:** When setting scaling mode to Manual, select the resolution from the drop-down menu.

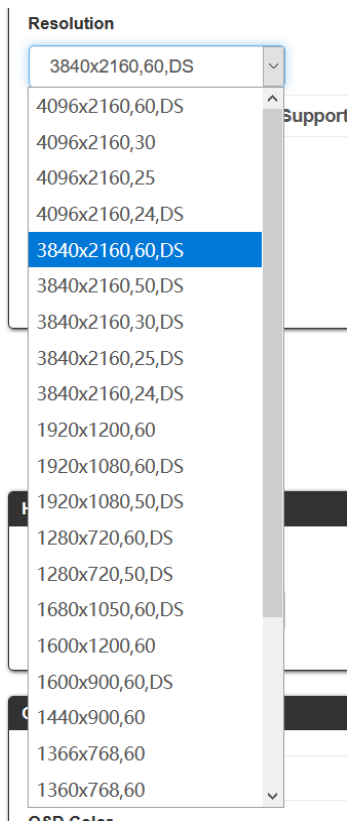

- **Show only EDID Display Supported (DS):** Click to select the item to change the resolution menu according to the EDID of the display or click to unselect it to show all resolutions. The default setting is unselected.
- **Aspect Ratio:**
 - a) Maintain: Set aspect ratio mode to maintain.
 - b) Stretch: Set aspect ratio mode to stretch. The default setting is Stretch.
- **Save EDID:** Save current EDID as a bin file to local PC.

(2) Display Settings

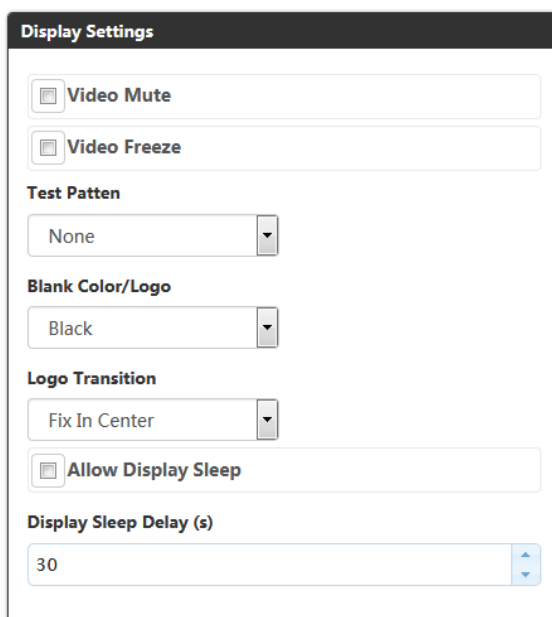

- **Video Mute:** Click to mute/unmute the video. The default setting is Unmute.
- **Video Freeze:** Click to freeze/unfreeze the video. The default setting is Unfreeze.
- **Test Patten:** Click to select test Patten from the drop-down menu. The default setting is NONE.
- **Blank color/Logo:** Click to select the blank color/logo showed on the display from the drop-down menu. The default setting is Black.
- **Logo Transition:** Click to select logo transition from the drop-down menu. The default setting is Fix In Center.
- **Allow Display Sleep:** Click to set display sleep enable/disable. The default Setting is disable.
- **Display Sleep Delay(s):** Set display sleep delay time when set Display Sleep enable. The default setting is 30(s).

(3) HDCP Settings



This section allows you to set HDCP Compliance from the drop-down menu. "AUTO", "HDCP2.2", "HDCP1.4", "NO HDCP". By default, Output HDCP Support is "AUTO", follow the input HDCP. For example, input HDCP is HDCP 2.2, output HDCP is also HDCP 2.2. The default setting is AUTO.

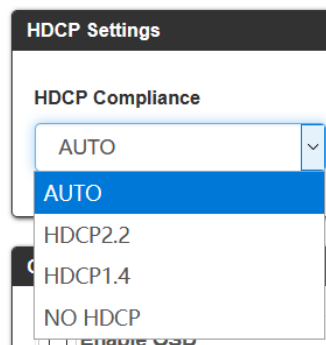

(4) Color Space Settings



Set Color Space from the drop-down menu. The default Color Space is RGB.

(5) On-screen Display

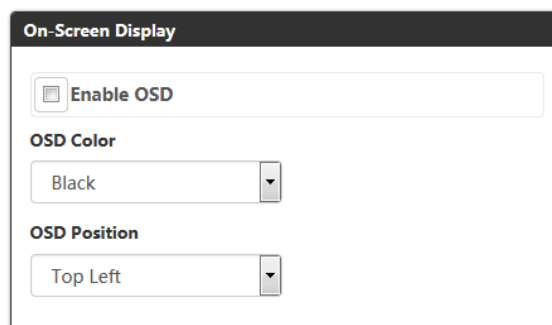

- **Enable OSD:** Set OSD function enable or disable. The default setting is Disable.

- **OSD Color:** Set OSD display color from the drop-down menu. The default setting is white characters on black background.
- **OSD Position:** Set OSD display position on the display. The default setting is Top Left.

(6) Image Adjustments

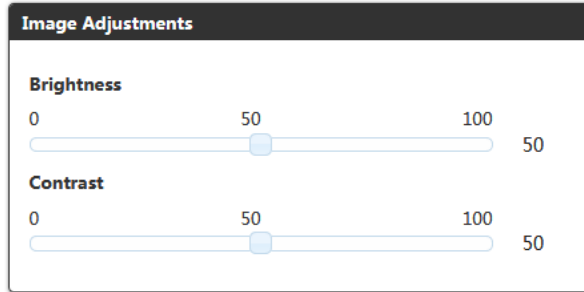

This section allows you to adjust the brightness and contrast of the image.

- **Brightness:** Slide the button to adjust the brightness of the image. The default brightness is 50.
- **Contrast:** Slide the button to adjust the contrast the contrast of the image. The default contrast is 50.

(7) Log Setup

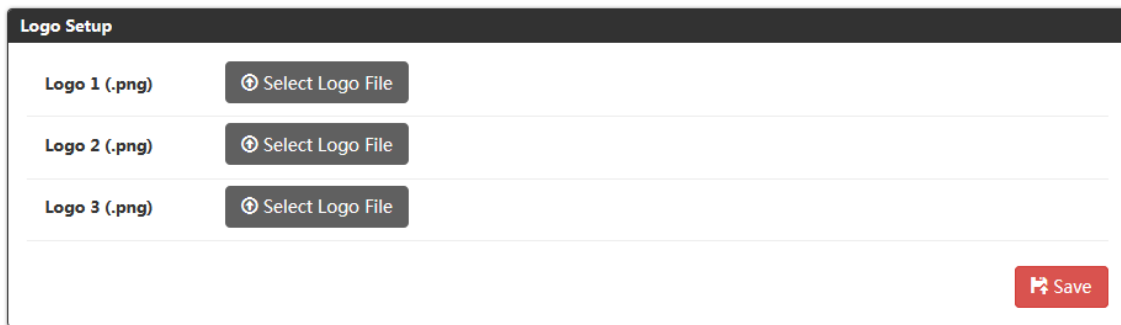

Select logo to display on the screen connected.

Click Select Logo File heightened in grey, select a logo from local PC.

- **Save:** Click to save the settings.

Audio



This section allows you to select Audio source for HDMI OUT/AUDIO OUT of the receiver.

- **Audio Output:** Select audio source from ALL, HDMI and Analog. The default setting is ALL.
- **ALL:** Audio will be output from both the HDMI OUT and the analog AUDIO OUT ports of the receiver.
- **HDMI:** Selecting HDMI will direct the device to output audio on HDMI OUT but not the analog AUDIO OUT.
- **Analog:** Selecting Analog will direct the device to output audio on analog AUDIO OUT but not the HDMI OUT.
- **Audio Mute:** Click to set Audio output mute/unmute. The default setting is Unmute.

Control

Log out



DXLINK Mode

Endpoint Extender

CEC Settings

Mode: NetLinx Local Passthrough

Output Port: HDMI

Manual Power On/Off: ON OFF

Auto Power On/Off: ON OFF

Delay Time (min):

RS232 Settings

Mode: NetLinx Local Passthrough

Manual Power On/Off: ON OFF

Auto Power On/Off: ON OFF

Delay Time (min):

Baud Rate: 115200

Parity Bits: NONE

Data Bits: 8

Stop Bits: 1

End Flag: None \r \n \r\n

Power On: Save

Power Off: Save

Apply

IR Settings

Note: IR Learning Steps under Local Mode

1. IR Receiver Cable to IR RX port.
2. Press "Power On" or "Power Off" button on remote controller.
3. Press "Learn" ICON on the WebGUI setting the given IR code for IR auto control.

Mode: NetLinx Local Passthrough

Manual Power On/Off: ON OFF

Auto Power On/Off: ON OFF

Delay Time (min):

Power On: Learn Save

Power Off: Learn Save

(1) DXLINK Mode

- **Endpoint:** Click to set the device to Endpoint mode.
- **Extender:** Click to set the device to Extender Mode.

NOTE:

- When the device is in Endpoint Mode, the CEC, RS232, and IR Settings are configured through NetLinx and can't be set through Web UI.
- When setting DXLINK Mode through the Web UI, the DIP Switch setting is ignored.

(2) CEC Settings

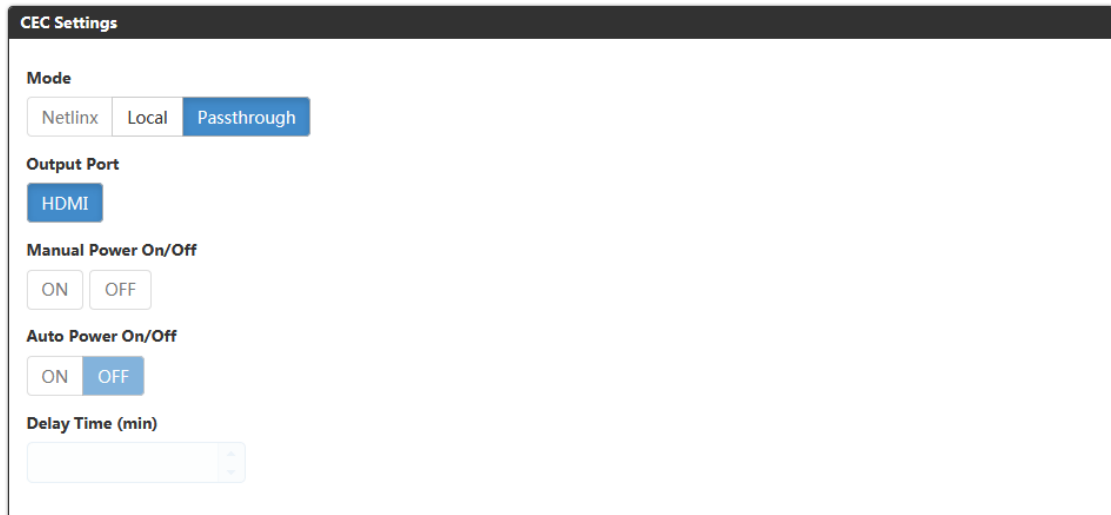

This section is used to set CEC settings parameters.

- **Mode:** Select CEC mode. When the endpoint is set to Extender mode, the default CEC Mode is Passthrough. In passthrough mode, all CEC commands are passed through between source and sink.

When the mode is set to passthrough, the CEC function is Passthrough. When set to Local mode, the following items can be configured.

- **Output Port:** When set to Local mode, the default setting is HDMI.
- **Manual Power On/Off:** Send power on/off command to the selected port manually.
- **Auto Power On/Off:** Click to select Auto control ON/OFF. The default setting is ON.
- **Delay Time (min):** When Auto Power On/Off is set to ON, Choose Auto Control time to set display auto power off time. For example, if the time is set to 2 minutes, when the output has no signal for more than 2 minutes, the display will power off automatically. If you click the button “OFF”, the auto power function is disabled.

(3) RS232 Settings

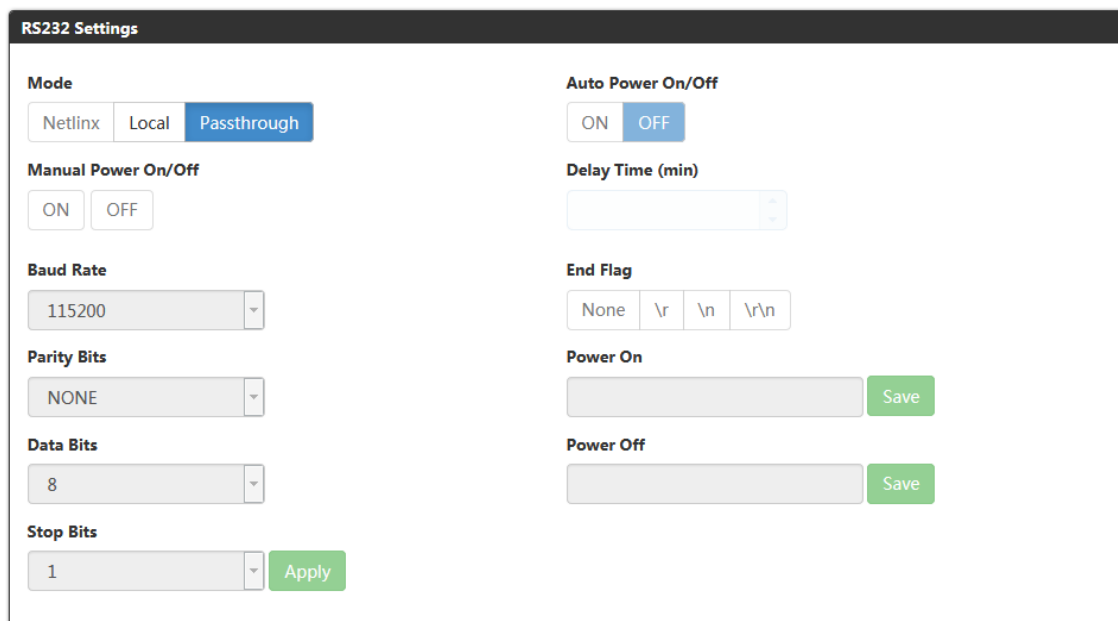

- **Mode:** Select RS232 control mode. When the endpoint is set to Extender mode, the default setting is Passthrough. In passthrough mode, all RS232 signals pass through between the RS232 transmitter and receiver. When set to Local mode, the following items can be configured:
- **Manual Power On/Off:** After set the commands of Power On/Off, click ON/OFF to send the commands to the

third-party device.

- **Auto Power On/Off:** Set Auto Power On/Off. The default setting is ON.
- **Delay Time:** When Auto Power On/Off is set to ON, Choose Auto Control time to send power off command time. For example, if the time is set to 2 minutes, when the output has no signal for more than 2 minutes, the device will power off automatically. If you click the button “OFF”, this function is free. The default setting is 2min.
- **Baud Rate:** Click the down arrow to select the baud rate. The default setting is 115200.
- **Parity Bits:** Click the down arrow to select the parity bits. The default setting is NONE.
- **Data Bits:** Click the down arrow to select the data bits. The default setting is 8 bits.
- **Stop Bits:** Click the down arrow to select the stop bits. The default setting is 1 bit.
- **Apply:** Click to take effect.
- **End Flag:** Select the ending flag after each RS232 command. The default setting is \n.
- **Power On:** Enter the RS232 command to turn on the projector and screen, then click “Save” button to take effect.
- **Power Off:** Enter the RS232 command to turn off the projector and screen, then click “Save” button to take effect.

(4) IR Settings

IR Settings

Note: IR Learning Steps under Local Mode

1. IR Receiver Cable to IR RX port.
2. Press "Power On" or "Power Off" button on remote controller.
3. Press "Learn" ICON on the WebGUI setting the given IR code for IR auto control.

Mode

Netlink Local **Passthrough**

Manual Power On/Off

ON OFF

Auto Power On/Off

ON **OFF**

Delay Time (min)

Power On

Learn Save

Power Off

Learn Save

When the DXLINK Mode is set to Extender Mode:

- **Mode:** Select IR control mode. The default setting is Passthrough. In Passthrough mode IR signals are passed through from IR transmitter to IR receiver.

When the mode is set to Local, the following items can be configured:

- **Manual Power On/Off:** After setting Power On/Off commands and finish IR learning, click to turn on/off the third-party device manually.
- **Auto Power On/Off:** Set Auto Power On/Off, the default setting is ON.
- **Delay Time: (min):** When Auto Power On/Off is set to ON, Choose Auto Control time to send power off command time. For example, if the time is set to 2 minutes, when the output has no signal for more than 2 minutes, the device will power off automatically. If you click the button “OFF”, this function is free. The default setting is

2min.

- **Power On:** Enter the IR command to turn on the third-party device.
- **Power Off:** Enter the IR command to turn off the third-party device.

Note: IR Learning Steps under Local Mode:

- a) Connect IR Receiver cable to IR RX port.
- b) Press Power On/Off button on remote controller.
- c) Press “Learn” icon to give IR code for IR auto control. And then click “Save”.

Network

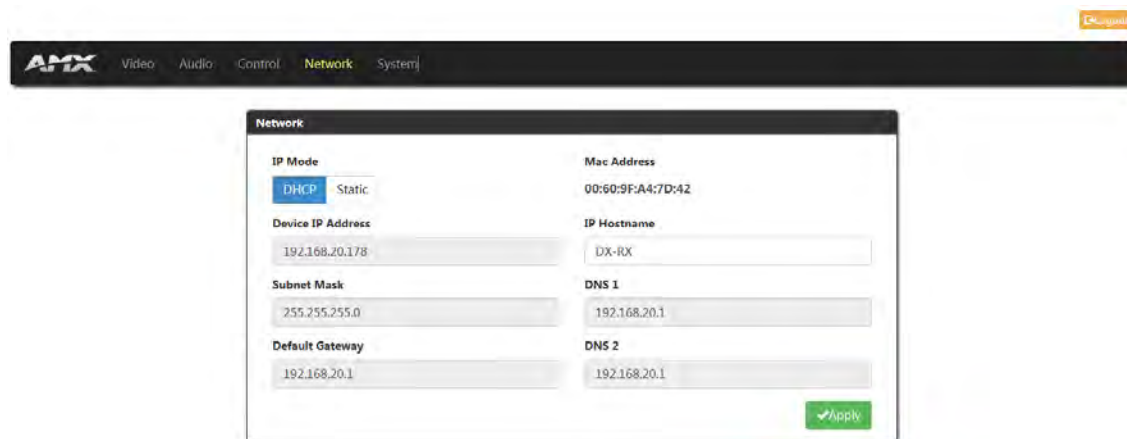

This Section allows you to set Network.

- **IP Mode:**
 - a) DHCP: When enabled, the IP address will be assigned automatically by the DHCP server connected.
 - b) Static: When enabled, set up the IP address manually.
- **MAC Address:** Show MAC address of the device.
- **Apply:** Click “Apply” to take effect.

System

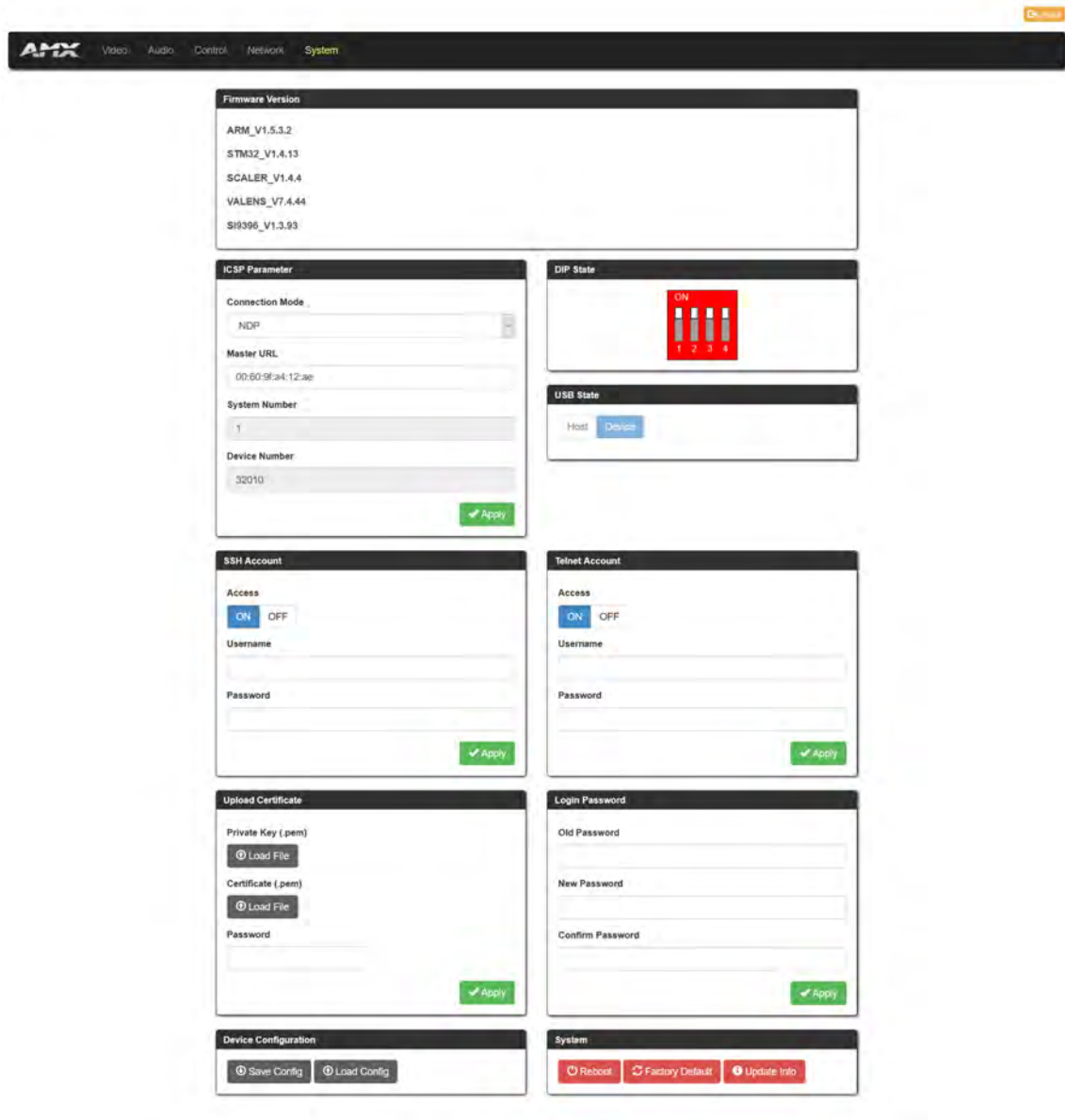

(1) Firmware Version



This section shows the current firmware version.

(2) ICSP Parameter

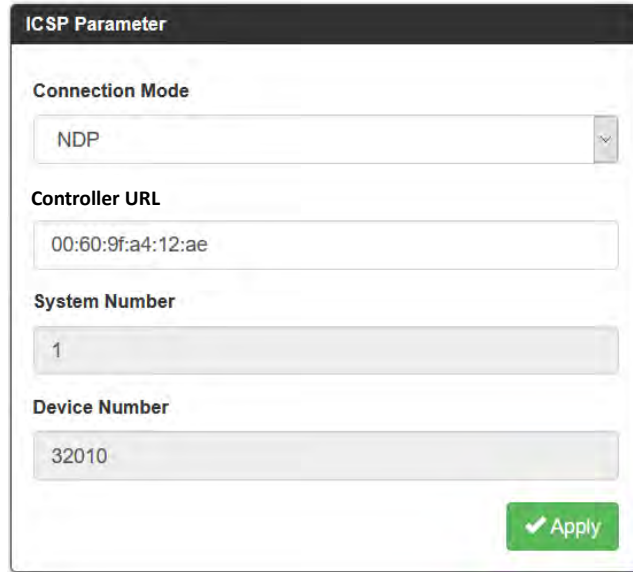

The screenshot shows a configuration window titled "ICSP Parameter". It has the following fields:

- Connection Mode:** A dropdown menu with "NDP" selected.
- Controller URL:** A text input field containing "00:60:9f:a4:12:ae".
- System Number:** A text input field containing "1".
- Device Number:** A text input field containing "32010".

An "Apply" button with a checkmark icon is located at the bottom right of the window.

In this column, users can set ICSP parameter.

- **Connection Mode:** Includes four options of NDP, Auto IP, URL/TCP, URL/UDP. The default setting is NDP.
- **Controller URL:** Input the connected Central Controller's URL.
- **System Number:** Use the Online Tree to determine it. By default, it is disabled to configure.
- **Device Number:** Use the Online Tree to determine it. By default, it is disabled to configure.
- **Apply:** Click "Apply" to make the settings take effect.

(3) DIP State

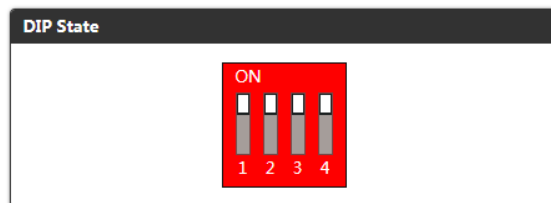

Show the current DIP Switch states.

(4) USB State



Show the USB Slide Switch position.

(5) SSH Account

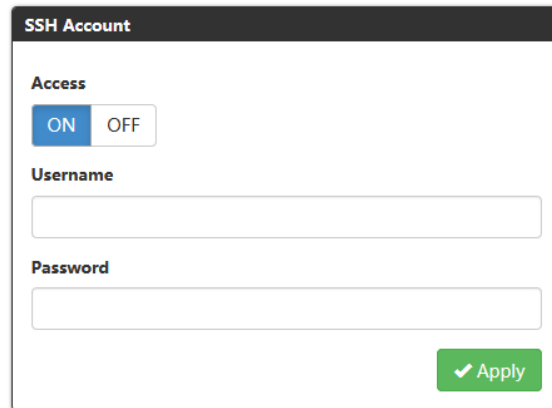

SSH Account is used to configure the SSH connection on/off, username and password of the account.

For SSH Account, the default username is **admin**, the default password is **password**.

- **Apply:** Click to perform the settings. It needs to reboot the device to take effect.

(6) Telnet Account

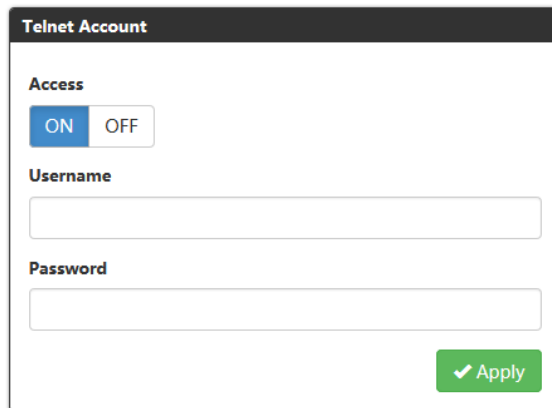

Telnet Account is used to configure Telnet connection, Username and Password of the account.

For Telnet Account, the default username and password are null.

- **Apply:** Click to perform the settings. It needs to reboot the device to take effect.

(7) Upload Certificate

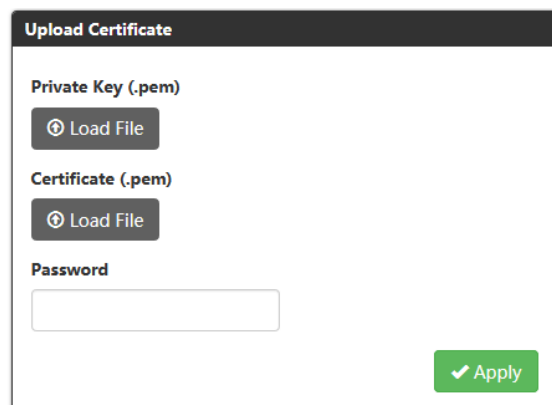

This section allows you to upload HTTPS Private and Certificate.

- **Apply:** Click Apply to take effect.
- **Password:** Input the password of the certificate loaded.

NOTE: Please reboot the device for setting changes to take effect.

(8) Login Password

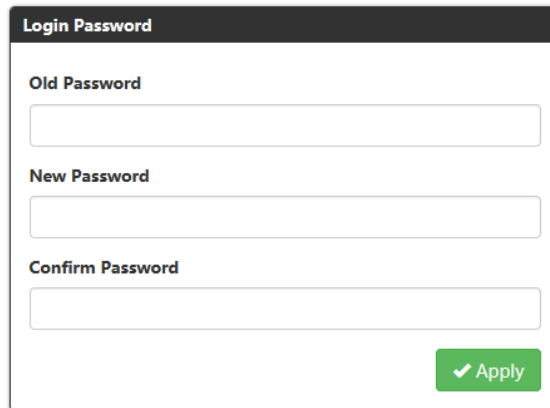

This section allows you to change login password.

- **Apply:** Click to save the settings.

The default password is “admin”.

(9) Device Configuration

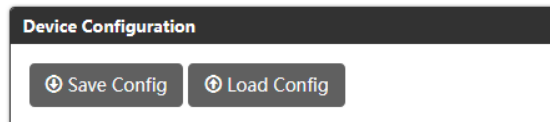

- **Save Config:** Click to save the current configuration as a bin file to local PC.
- **Load Config:** Click to load the saved configuration bin file.

(11) System

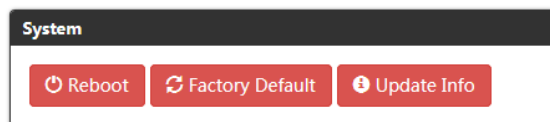

This section allows you to reboot the device, set the device to factory and check the Update Information.

- **Reboot:** Click Reboot to reboot the device. Wait about 2-3 minutes to refresh the web page.

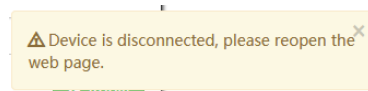

- **Factory Default:** Click “Factory Default” to reset the device to factory settings. Wait about 2-3 minutes to refresh the web page.
- **Update Info:** Clicking “Update Info” will direct you to a new page that displays the Update process status.

Update Status

Waiting for update info...

Firmware Upgrade

DX-TX-4K60 and DX-RX-4K60 can use 'KIT' files or '.swu' files for firmware upgrade.

Upgrade Firmware through NetLinX

Before You Start

1. Verify that you have the latest version of NetLinX Studio on your PC.
If the version is not the latest –
 - Use the Web Update option in NetLinX Studio's Help menu to obtain the latest version.Or
 - Go to www.amx.com to download the latest version.
2. Download the latest firmware (KIT) file to your PC. (Place KIT files on a local drive for speedy throughput.)
3. Verify the following:
 - a) Check to be sure #3 Toggle DIP Switch on front panel of device are set to ON.
 - b) Verify that an Ethernet/RJ-45 cable is connected from the switcher's integrated Central Controller to the network (e.g., from the LAN 100/1000 port on an Enova DGX 3200 to a LAN).
 - c) Verify the Switcher is powered on.
4. Launch NetLinX Studio and open the Online Tree.
5. Bind the target device to the integrated Central Controller: Select and right-click the DX-TX-4K60/DX-RX-4K60. From the context sensitive menu, select "**Network Bind/Unbind Device**" (be sure the check box is selected). Click "OK".

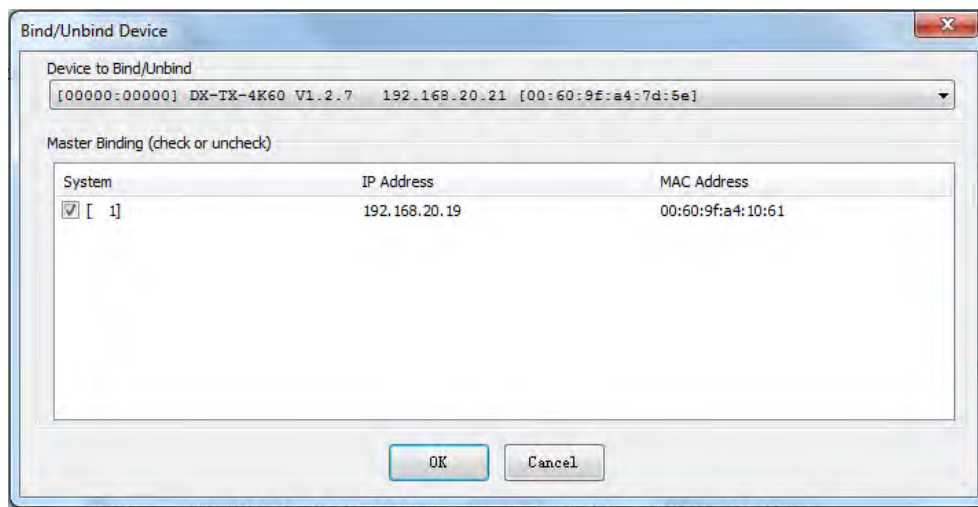

6. Determine the Device Number assigned to the target Transmitter/Receiver when it was bound. For the Device Number location, see "*NetLinX Programming*" Section.

Transferring KIT Files

The system will be non-operational during the upgrade procedure below.

1. In NetLinX Studio from the **Tools** menu, select "**Firmware Transfers > Send to NetLinX Device**", select "**Stop Communications**" in the following box, and then enter the **Send to NetLinX Device** dialog box.
2. Click  to navigate to the target directory. The selected directory path is displayed in the Location text box. KIT files in the target directory display under Files.
3. Select the appropriate KIT file from the list.
4. Enter the Device and System numbers (see "*Device Number and Ports*" part of "*NetLinX Programming*" section) for the target module in the Device and System text boxes.

NOTE: Use the **Online Device Tree** to determine the device's assigned IDs, if it has been changed.

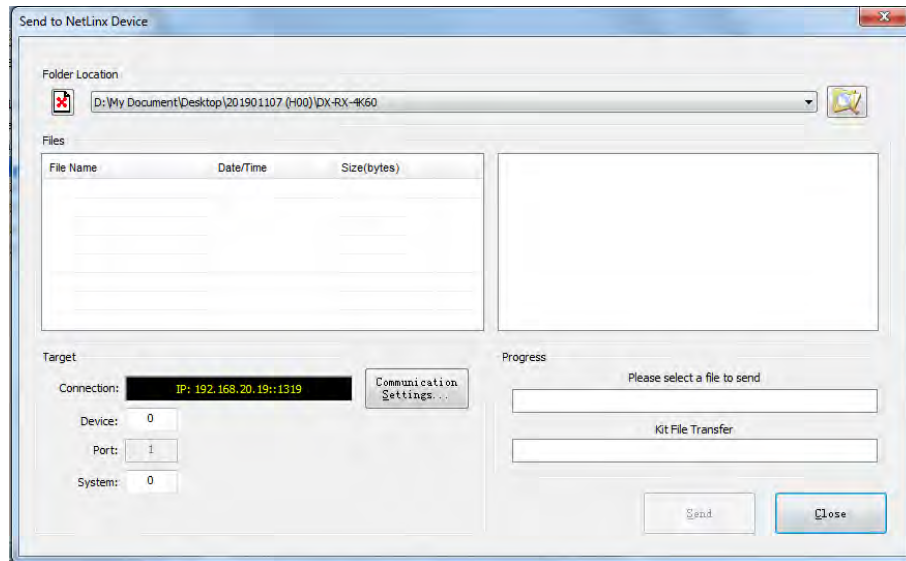

5. Click **Send** to upgrade the firmware on the DXLink-TX-4K60/DX-RX-4K60.
 - The Power LED blinks during the process for upgrading the firmware (this is normal).
 - The progress of the upgrade displays in the Upload Status field. Status is also indicated in the Status bar at the bottom.
 - The success of the upgrade or any errors that occur will be reported. *

* If an incorrect file has been selected or if the upgrade has failed, the Power LED will briefly illuminate solid green then change to a slow blink. To recover (in either case), reboot the Transmitter/Receiver and browse to select the correct file and then re-send.
6. Close the window when the transfer is complete.
7. When the process is complete, cycle power:
 - a) Unplug the desktop power supply from the AC power source and plug it back in.Or
 - b) If the power source is the switcher, unplug the RJ-45 connector from the DXLink port on the module and plug it back in.
8. After finishing upgrading, refresh the System Online Tree, and check to be sure the firmware version matches the version selected for the upgrade.

NOTE: When the transmitter and receiver are connected directly (in extender mode or endpoint mode (standalone)), you can check the upgrade status through web UI (See “Update Info” part of “Web UI Control” section).

Upgrade the firmware through USB Port

1. Create a folder on a USB drive named “dxlinkfw” and copy the “.swu” firmware files for the transmitter and receiver to this folder on the USB drive.
2. Insert the USB disk into the USB-A port of the device to be updated.
3. Power on the device and wait at least 40 seconds for the unit to fully booted.
4. Press the ID button 5 times within 3 seconds to enter Upgrade Mode.
5. The “Status” LED will be flashing rapidly to indicate that the firmware files are being copied.

IMPORTANT: DO NOT REMOVE THE USB DRIVE OR POWER OFF THE DEVICE WHILE THE STATUS LED IS FLASHING.

6. When the “Status” LED stops flashing, the upgrade is complete, and the endpoint will automatically reboot.
7. Remove the USB drive from the USB port.

NOTE: TX and RX files can be copied to the USB drive at the same time, and they will be recognized automatically.

APPENDIX A: Factory Default Configuration

Factory Default Configuration	
Hardware Default Setting	
Switcher	Setting
USB Mode Switcher	TX - USB Host, RX - USB Device
4-Pin DIP Switcher	0000 (0-OFF, 1-ON)
Software Default Parameters	
Parameter	Value
MAC Address	As set in factory
Serial Number	As set in factory
Ethernet Mode	Auto (i.e., speed, duplex, both, auto)
IP Addressing Mode	DHCP
IP Address (for static mode)	192.168.1.2
Netmask (for static mode)	255.255.255.0
Gateway (for static mode)	192.168.1.1
DNS 1 (for static mode)	8.8.8.8
DNS 2 (for static mode)	8.8.8.8
DNS Domain	amx.com
Hostname	Model (e.g., DX-RX-4K60); after factory reset, model with last 7 digits of serial#
Central Controller Connection Mode	NDP
Central Controller URL (for TCP and UDP URL modes)	" " (blank)
Central Controller Connection Port Number (for TCP and UDP modes)	1319
Friendly-Name	" " (blank) NOTE: If the Friendly Name is non-blank, both Friendly Name and Location are concatenated to make NDPSTRING2, otherwise NDPSTRING2 is generated from the unit's serial number.
Location	" " (blank)
Stored MAC Address of Central Controller (for NDP binding)	00:00:00:00:00:00
ICSP Device Number	0 (0= receive dynamic device number form Central Controller)
System Number	0
Telnet Port	23 (A value of 0 disable the Telnet server. Telnet is enabled by default)
SET BAUD	9600, N, 8, 1
CTOF Time	5 (0.5 seconds)
CTON Time	5 (0.5 seconds)
CEC_DISP_AUTO	ON
CEC_SLEEP_TIMEOUT	2 minutes

Factory Default Configuration	
SSH Username	" " (blank, no username)
SSH Password	" " (blank, no password)
Telnet Username	" " (blank, no username)
Telnet Password	" " (blank, no password)
Standalone Webserver Password	admin
Transmitter Only	
VIDIN_RES_AUTO	ENABLE
VIDIN_EDID	ALL RESOLUTIONS
VIDIN_PREF_EDID	4096X2160,30
VIDIN_HDR	NONE
VIDIN_HDCP	ENABLE
VIDIN_FORMAT	HDMI
VIDOUT_MUTE	DISABLE
AUDIN_DIGITAL	Basic
AUDIN_FORMAT_AUTO	ENABLE
AUDIN_FORMAT	HDMI
Receiver Only	
VIDOUT_ASPECT_RATIO	MAINTAIN
VIDOUT_TESTPAT	OFF
VIDOUT_BLANK	BLACK
VIDOUT_LOGO	FIX IN CENTER
VIDOUT_SCALE	AUTO
VIDOUT_RES_REF	1920x1080p, 60hz
VIDOUT_COLOR_SPACE	RGB
VIDOUT_MUTE	DISABLE
VIDOUT_FREEZE	DISABLE
VIDOUT_SLEEP	DISABLE
VIDOUT_SLEEP_DELAY	30 (timer)
VIDOUT_BRIGHTNESS	50 (50 is bypass for video input brightness)
VIDOUT_CONTRAST	50 (50 is bypass for video input contrast)
VIDOUT_OSD	DISABLE
VIDOUT_OSD_COLOR	BLACK
VIDOUT_OSD_POS	TOP LEFT
VIDOUT_HDCP	FOLLOW
AUDOUT_MUTE	DISABLE
AUDOUT_FORMAT	ALL

APPENDIX B: Telnet Commands

No.	Command	Description	Example
1	? Or Help	Displays all the supported commands	<pre>>help cpu usage Displays the total CPU usage date Display the current date. get ip Show the IP configuration of this device. ></pre>
2	DEVICE STATUS <D:P:S>	Displays device status of a specified device, port, system (<D:P:S>).	<pre>>device status 32002:1:0 Device Status ----- Device 32002 Harman International, DX-TX-4K60, V1.2.11 contains 14 Ports Channels:255 Levels:8 MaxStringLen=2048 Types=8 bit MaxCommandLen=1024 Types=8 bit The following input channels are on:none The following output channels are on:none Level 1=0 Supported data types=UByte, UInt Level 2=0 Supported data types=UByte, UInt Level 3=0 Supported data types=UByte, UInt Level 4=0 Supported data types=UByte, UInt Level 5=0 Supported data types=UByte, UInt Level 6=0 Supported data types=UByte, UInt Level 7=0 Supported data types=UByte, UInt Level 8=0 Supported data types=UByte, UInt ></pre>
3	DIPSWITCH	Displays the current values of the DIP switch's four toggles.	<pre>>dipswitch Dipswitch - ON OFF OFF OFF ></pre>
4	SEND_COMMAND [D:P:S,"NAME,COMMAND"]	<p>Sends the specified SEND_COMMAND (does not work with queries) to the current DXLink Transmitter or Receiver.</p> <p>The device can be on any system that the Central Controller you are connected to can reach. You can specify the device number, port, and system; or the name of the device that is defined in the DEFINE_DEVICE section of the Program.</p>	<pre>>send_command 6501:1:0,"VIDIN_FORMAT-HDMI"</pre>
5	EXIT	Closes this terminal session.	<pre>>exit</pre>
6	FACTORYFWIMAGE	Resets unit to factory firmware image and reboots the DXLink Transmitter / Receiver or Switcher.	<pre>>factoryfwimage</pre>

No.	Command	Description	Example
7	GET CONFIG	Displays the current connection settings.	<pre> >get config Device number: 7010 Connection Settings ----- Mode: NDP System Number: 2155 Central Controller IP/URL: 192.168.43.83 Central Controller Port: 1319 Username: The username of telnet Password: The password is not displayed IP Settings ----- HostName: DXL-RX-36d0110 Type: DHCP IP Address: 192.168.43.63 Subnet Mask: 255.255.255.0 Gateway IP: 192.168.43.2 MAC Address: 00:60:9f:99:26:f1 DHCP Server : 192.168.43.2 --- cannot get IP address of DHCP server currently Lease Origin : THU 01/09/2031 12:59:02 Lease Duration: SUN 01/12/2031 12:59:02 (259200 sec) Lease Renew (T1): SAT 01/11/2031 00:59:02 (129600 sec) Lease Rebind (T2): SUN 01/12/2031 03:59:02 DNS Servers ----- Domain suffix: amx.internal Entry 1: 192.168.40.7 Entry 2: 192.168.40.8 > </pre>
8	GET CONNECTION	shows the Central Controller connection settings.	<pre> >get connection Connection Settings ----- Mode: UDP URL System Number: 1 Central Controller IP/URL: 192.168.44.53 Central Controller Port: 1319 Username: --- The username of telnet Password: The password is not displayed > </pre>
9	GET DEVICE	Displays the device number.	<pre> >get device Device Number:32002 > </pre>
10	GET DNS	Displays the list of DNS entries	<pre> >get dns DNS Servers ----- Domain suffix: amx.internal Entry 1: 192.168.40.7 Entry 2: 192.168.40.8 > </pre>

No.	Command	Description	Example												
11	GET ETHERNET MODE	Displays the current LAN configuration.	> get ethernet mode Ethernet mode is auto.												
12	GET FRIENDLY	Displays the device's friendly name (for NDP).													
13	GET IP	Show the IP configuration of this device. The device displays its D:P:S, Host Name, Type (DHCP or Static), IP Address, Subnet Mask, Gateway IP, and MAC Address.	> get ip HostName DXL-RX-36d0110 Type DHCP IP Address 192.168.43.63 Subnet Mask 255.255.255.0 Gateway IP 192.168.43.2 MAC Address 00:60:9f:99:26:f1 >												
14	GET LOCATION	Displays the location parameter for NDP (set by the SET LOCATION command).													
15	GET SN	Returns the device's serial number.													
16	MSG [ON OFF]	<p>Enables/Disables extended diagnostic messages.</p> <p>Usage: msg [argument]</p> <p>This command allows system logs to be redirected to the terminal session. There are multiple log levels, which are described below.</p> <p>Arguments:</p> <table> <tr> <td>on</td> <td>Enable default [warning] system log level</td> </tr> <tr> <td>debug</td> <td>Enable all system debug messages</td> </tr> <tr> <td>info</td> <td>Enable info system log level</td> </tr> <tr> <td>warning</td> <td>Enable warning system log level</td> </tr> <tr> <td>error</td> <td>Enable error system log level</td> </tr> <tr> <td>off</td> <td>Disable system log output to terminal session</td> </tr> </table> <p>MSG On [error warning info debug] sets the terminal program to display log messages generated by the Central Controller. The level of log printed to the terminal window depends both on the level used when sending the message and the output level selected with "msg on."</p> <p>For example if log output is enabled via "msg on warning" then logs produced at levels AMX_ERROR and AMX_WARNING will be displayed, but not logs produced at levels AMX_INFO or AMX_DEBUG.</p> <p>The order of severity from highest to lowest is ERROR, WARNING, INFO, DEBUG.</p> <p>If no severity is supplied with "msg on", the default setting is WARNING.</p> <p>MSG OFF disables the display.</p>	on	Enable default [warning] system log level	debug	Enable all system debug messages	info	Enable info system log level	warning	Enable warning system log level	error	Enable error system log level	off	Disable system log output to terminal session	<p>> MSG ON Extended diagnostic information messages turned on. > > MSG OFF Extended diagnostic information messages turned off. ></p>
on	Enable default [warning] system log level														
debug	Enable all system debug messages														
info	Enable info system log level														
warning	Enable warning system log level														
error	Enable error system log level														
off	Disable system log output to terminal session														
17	NDP UNBIND	Clears the NDP binding to a Central Controller (takes effect after next boot).													

No.	Command	Description	Example
18	PING [ADDRESS]	Pings an address (IP or URL), to test network connectivity to and confirms the presence of another networked device. The syntax matches to the PING application in Windows or Linux.	> ping 192.168.29.209 192.168.29.209 is alive. >
19	REBOOT	Reboots the device.	> REBOOT Rebooting...
20	RENEW DHCP	Renews / releases the current DHCP lease for the Central Controller. Note (NX, NI & DVX Central Controllers): The Central Controller must be rebooted to acquire a new DHCP lease. Note (Solecis Digital Switchers & DXLink Transmitters/Receivers): Because sending this command can cause the unit to acquire a new DHCP address and the functionality of the endpoints is depend on the mated IP addresses of the TX (host) and RX (device), the USB connection may need to be re-established.	> RENEW DHCP Previous DHCP name: 192.168.1.10 Current DHCP name: 192.168.1.20
21	RESET FACTORY	Resets configuration back to factory defaults. This command will cause an automatic reboot.	> reset factory
22	SET CONNECTION	Sets the Central Controller connection settings interactively, allowing the user to specify the mode (for descriptions of various connection modes) <ul style="list-style-type: none"> If the mode is TCP or UDP, the Central Controller URL and port number can be specified as well. If Auto is selected, the System number can be specified. After all data is entered, if the parameters have changed, the DXLink Transmitter or Receiver will disconnect from the Central Controller, and begin trying to connect with the new settings. NOTE: These changes do not require a reboot to take effect. 	> set connection --- Enter New Values or just hit Enter to keep current settings --- Enter Mode Type T for TCP/URL, U for UDP/URL, N for NDP or A for Auto and then Enter: Icsp_Auto A Enter Central Controller System Number: 1 1 --- New settings --- System Number 1 Central Controller Port 1319 Is this correct? Type Y or N and Enter -> Y Changed && Saved
23	SET DEVICE	Sets the device number, and stores it in non-volatile memory. Syntax: SET DEVICE <num> The valid range of device numbers is 0 to 31999. If the user enters a number outside that range, then no change will be made and the DXLink Transmitter or Receiver will issue an error message. A Device Number of '0' means that the DXLink Transmitter or Receiver will accept the auto-assigned device number from the Central Controller. If the new device number is different from the old device number, the DXLink Transmitter or Receiver will disconnect from the Central Controller, and begin trying to connect with the	> set device Please input device name: Old device name: 32001 New device name: 42001 Would you like to save this setting(Y/N) y Setting is ok.

No.	Command	Description	Example
		<p>new settings.</p> <p>NOTE: These changes do not require a reboot to take effect.</p>	
24	SET DNS	<p>Sets the DNS configuration of the DXLink Transmitter or Receiver, only as applied to Static IP Mode (DNS settings in DHCP Mode are received from the DHCP server).</p> <p>Syntax: SET DNS</p> <p>This command prompts you to enter a Domain Name, DNS IP #1, DNS IP #2, and DNS IP #3. Enter Y (yes) to approve/store the information in the Central Controller. Enter N (no) cancels the operation.</p> <p>NOTE: The device must be rebooted to enable new settings.</p>	<p>>set dns -- Enter New Values or just hit Enter to keep current settings -- Enter Domain Suffix: amx.com Enter DNS Entry 1 : 192.168.20.5 Enter DNS Entry 2 : 12.18.110.8 Enter DNS Entry 3 : 12.18.110.7 You have entered: Domain Name: amx.com</p> <p>DNS Entry 1: 192.168.20.5 DNS Entry 2: 12.18.110.8 DNS Entry 3: 12.18.110.7</p> <p>Is this correct? Type Y or N and Enter -> Y Settings written. Device must be rebooted to enable new settings</p>
25	SET ETHERNET MODE	<p>This command sets the current LAN configuration in per new mode.</p> <p>Syntax: SET ETHERNET MODE <newmode></p> <p>Values for newmode are: auto Or 100 full or 10 halves</p> <p>NOTE: This command requires a reboot to enable new settings.</p>	<p>>set ethernet mode Current ethernet mode: Auto Enter new ethernet mode: 10 halves</p> <p>Warning: When setting ethernet mode to 10 halves, it must reset device to factory default if need change ethernet mode to be Auto/100 full.</p> <p>Would you like to set the ethernet mode (y/n): y New ethernet mode set, reboot the device for the change to take effect.</p>
26	SET FRIENDLY	<p>Set the device's friendly name for NDP to <name>.</p> <p>Syntax: SET FRIENDLY <name></p> <p>Maximum length = 25 characters. If the name entered exceeds 25 characters, it will be truncated.</p> <p>The value is stored in non-volatile memory. If no value specified, an automatic name consisting of AMX, the product name, and serial number will be used.</p> <p>NOTE: This command requires a reboot to enable new settings.</p>	<p>>set friendly</p> <p>Please input friendly name:</p> <p>Old friendlyname: DX-RX New friendlyname: 111 Would you like to save this setting(Y/N) y Setting is ok, you should reboot that make it effective</p>

No.	Command	Description	Example
27	SET IP	<p>Sets the IP configuration of a specified device. Enter a Host Name, Type (DHCP or Fixed), IP Address, Subnet Mask, and Gateway IP Address.</p> <p>IMPORTANT: Host Names may only contain ASCII letters “a” through “z” (not case-sensitive), digits “0” through “9”, and the hyphen (“-”).</p> <p>NOTE: DHCP implies “DHCP with link-local fallback”.</p> <p>NOTE: For NetLinx Central Controller s, the Host Name can only consist of alphanumeric characters.</p> <ul style="list-style-type: none"> Enter Y (yes) to approve/store the information on the Central Controller. Enter N (no) to cancel the operation. <p>NOTE: This command requires a reboot to enable new settings.</p> <p>NOTE: DXLink Modules can also be set to Static IP or DHCP Mode via the front panel ID Pushbutton.</p>	<p>>set ip</p> <p>--- Enter New Values or just hit Enter to keep current settings ---</p> <p>Enter Host Name: DXL-RX-36d0110</p> <p>Enter IP type. Type D for DHCP or S for Static IP and then Enter: S</p> <p>Enter IP Address 192.168.2.201 192.168.2.202</p> <p>Enter Netmask 255.255.240.0 255.255.255.0</p> <p>You have entered: Host Name DXL-RX-36d0110 Type Static IP IP Address 192.168.2.202 Netmask 255.255.255.0 Is this correct? Type Y or N and Enter -> y Settings written. Device must be rebooted to enable new settings.</p>
28	SET LOCATION	<p>Sets the location parameter for NDP.</p> <p>Syntax: SET LOCATION <location> Maximum length = 25 characters. If the name entered exceeds 25 characters, it will be truncated.</p> <p>NOTE: This command requires a reboot to enable new settings.</p>	<p>>set location</p> <p>Please input location:</p> <p>Old location: New location: 333 Would you like to save this setting(Y/N) y Setting is ok , you should reboot that make it effective</p>
29	SET TELNET USERNAME	<p>NOTE: This command is supported but is not presently in the Help file list of commands.</p> <p>Sets the Username for a secure Telnet session. Default = blank (no username required)</p>	<p>>set telnet username</p> <p>Enter Telnet new username 123 Would you like to set this username (y/n) y (please set telnet password)</p> <p>Changed && Saved</p>
30	SET TELNET PASSWORD	<p>NOTE: This command is supported but is not presently in the Help file list of commands.</p> <p>Sets the Username for a secure Telnet session. Default = blank (no username required)</p>	<p>>set telnet password</p> <p>Enter Telnet new password 456 Would you like to set this password (y/n) y Changed && Saved</p>
31	SET TELNET PORT	<p>Sets the device’s IP port listened to for Telnet connections.</p> <p>Syntax: >SET TELNET PORT Current telnet port number = 23 Enter new telnet port number (Usually 23)(0 = disable Telnet): Once you enter a value and press the Enter key, you get the following message: Setting telnet port number to 23 New telnet port number set, reboot the device for</p>	<p>>set telnet port</p> <p>Current telnet port number = 23 Enter new telnet port number 25 Setting telnet port number to 25 New telnet port number set, reboot the device for the change to take effect.</p>

No.	Command	Description	Example
		<p>the change to take effect.</p> <p>NOTE: This command requires a reboot to enable new settings.</p> <p>IMPORTANT: If you set the Telnet port to "0" to disable it, you will need to reset it with a SEND_COMMAND in NetLinx Studio</p>	
32	SHOW CONNECTION LOG	Shows the Central Controller connection log for the device.	
33	SHOW CONNECTION STATS	Shows the connection statistics for the device.	<pre>>show connection stats Connection Statistics Total Last 15 Minutes ===== ICSP Messages: 10039 received 333 received 10038 transmitted 333 transmitted Blink Messages: 5014 received 166 received IP Statistics: RX packets:29298 errors:0 discarded:0 TX packets:15286 errors:0 discarded:0</pre>
34	SHOW LOG	<p>Displays the log of messages stored in the Central Controller 's memory. The Central Controller logs all internal messages and keeps the most recent messages.</p> <p>The log contains:</p> <ul style="list-style-type: none"> Entries starting with first specified or most recent Date, Day, and Time message was logged Which object originated the message The text of the message: <p>SHOW LOG [start] [end] SHOW LOG ALL</p> <ul style="list-style-type: none"> - <start> specifies message to begin the display. - If start is not entered, the most recent message will be first. - If end is not entered, the last 20 messages will be shown. - If <ALL> is entered, all stored messages will be shown, starting with the most recent. 	
35	SHOW VS100 STATS	Displays DXLink transport information (MSE values, length, etc.).	<pre>>show vs100 stats</pre>
36	WD	<p>Queries/enables/disables the Offline Recovery Mechanism</p> <p>IMPORTANT: A reboot is required after setting the recovery mechanism before the new setting takes effect.</p> <p>Syntax: WD Queries the module for the setting of the Offline Recovery Mechanism. WD ON Sets the recovery mechanism to ON. WD OFF Sets the recovery mechanism to OFF (default).</p>	<pre>>wd Offline Recovery Mechanism is ON >wd on >wd off</pre>

APPENDIX C: ICSP Commands

DX-TX-4K60

NO.	Description	Command	Example
Video SEND_COMMANDs are sent to Port 7			
1	?VIDIN_STATUS	<p>Command: SEND_COMMAND <DEV>, ""?VIDIN_STATUS""</p> <p>Return: VIDIN_STATUS-<status></p> <p>Description: Request the status of the video input on the Transmitter.</p> <p>Variables: <status> = { NO SIGNAL; VALID SIGNAL; UNKNOWN SIGNAL; }</p>	<p>Command: SEND_COMMAND VIDEO_INPUT_1,""?VIDIN_STATUS""</p> <p>Return: VIDIN_STATUS-VALID SIGNAL</p> <p>Description: There is a Valid signal on input HDMI port.</p>
2	?VIDIN_RES_REF	<p>Command: SEND_COMMAND <DEV>, ""?VIDIN_RES_REF""</p> <p>Return: VIDIN_RES_REF- <horizontal>x<vertical>,<rate></p> <p>Description: Request the resolution and refresh rate of the video through the Transmitter.</p> <p>Variables: Valid responses: horizontal = An integer value representing the horizontal. vertical = An integer value representing the vertical. May have an additional qualifier such as 'i' or 'p'. rate = An integer value representing the refresh rate.</p>	<p>Command: SEND_COMMAND VIDEO_INPUT_1,""?VIDIN_RES_REF""</p> <p>Return: VIDIN_RES_REF-4096x2160,30</p> <p>Description: Current active resolution and refresh rate of the video through the Transmitter is 4096x2160, 30.</p>
3	VIDIN_RES_AUTO	<p>Command: SEND_COMMAND <DEV>, VIDIN_RES_AUTO-<ENABLE DISABLE>""</p> <p>Return: VIDIN_RES_AUTO-<ENABLE DISABLE></p> <p>Description: Enables or disables whether the video input port addressed supposed to have its resolution auto detected.</p>	<p>Command: SEND_COMMAND VIDEO_INPUT_1,""VIDIN_RES_AUTO-ENABLE""</p> <p>Return: VIDIN_RES_AUTO-ENABLE</p> <p>Description: Smart EDID for HDMI input port is ENABLE, the preferred resolution for video input port is generated by comparing HDMI loop port EDID and DXLink port EDID.</p>

NO.	Description	Command	Example
		Variables: <ul style="list-style-type: none"> ENABLE - Default, the preferred resolution for video input port is generated by comparing HDMI loop port EDID and DXLink port EDID (Smart EDID) DISABLE - the preferred resolution is manually defined by VIDIN_EDID 	
4	?VIDIN_RES_AUTO	Command: SEND_COMMAND <DEV>, "?VIDIN_RES_AUTO" Return: VIDIN_RES_AUTO-<ENABLE DISABLE> Description: Request to see the video input port's auto resolution is set to enable or disable. Variables: <ul style="list-style-type: none"> ENABLE - Default, the preferred resolution for video input port is generated by comparing HDMI loop port EDID and DXLink port EDID (Smart EDID) DISABLE - the preferred resolution is manually defined by VIDIN_EDID 	Command: SEND_COMMAND VIDEO_INPUT_1, "?VIDIN_RES_AUTO" Return: VIDIN_RES_AUTO-DISABLE Description: Smart EDID for HDMI input port is disable, it will work under manual mode, be defined by VIDIN_EDID.
5	VIDIN_EDID	Command: SEND_COMMAND <DEV>,"VIDIN_EDID-<source>" Return: VIDIN_EDID-<source> Description: Set the EDID source to active on video input port. Variables: source = { ALL HD RESOLUTIONS, (Default) HD WIDE-SCREEN, HD FULL-SCREEN, 4K, 4K60, MIRROR OUT LOCAL, MIRROR OUT 1, CUSTOM, } }	Command: SEND_COMMAND VIDEO_INPUT_1,"VIDIN_EDID-MIRROR OUT 1" Return: VIDIN_EDID-MIRROR OUT 1 Description: Current active EDID is Copy from sink display on DXLink port for video input port.

NO.	Description	Command	Example
6	?VIDIN_EDID	<p>Command: SEND_COMMAND <DEV>,""?VIDIN_EDID"</p> <p>Return: VIDIN_EDID-<source></p> <p>Description: Request the EDID source is in active status on video input port.</p> <p>Variables: source = { ALL HD RESOLUTIONS, (Default) WIDE-SCREEN, FULL-SCREEN, 4K, 4K60, MIRROR OUT LOCAL, MIRROR OUT 1, CUSTOM, }</p>	<p>Command: SEND_COMMAND VIDEO_INPUT_1,""?VIDIN_EDID"</p> <p>Return: VIDIN_EDID-MIRROR OUT 1</p> <p>Description: Current active EDID is Copy from sink display on DXLink port for video input port.</p>
7	VIDIN_PREF_EDID	<p>Command: SEND_COMMAND <DEV>,"VIDIN_PREF_EDID- <resolution,refresh>"</p> <p>Return: VIDIN_PREF_EDID-<resolution.refresh></p> <p>Description: Set the preferred resolution for the EDID source to HDMI input port. Only set the preferred resolution if using the VIDIN_EDID command to set the EDID source to All Resolutions, Wide-screen, Full-screen, or 4K, 4K60.</p> <p>Variables: <resolution.refresh> varients = VIC list in EDID source and default prefer resolution is the EDID source's prefer resolution</p>	<p>Command: SEND_COMMAND VIDEO_INPUT_1,"VIDIN_PREF_EDID- 1920x1200,60"</p> <p>Return: VIDIN_PREF_EDID-1920x1200,60</p> <p>Description: Set preferred resolution of the EDID source for HDMI input to EDID (1920x1200@60Hz).</p>
8	?VIDIN_PREF_EDID	<p>Command: SEND_COMMAND <DEV>, ?VIDIN_PREF_EDID"</p> <p>Return: VIDIN_PREF_EDID-<resolution,refresh></p> <p>Description: Request the preferred resolution of the EDID source for HDMI input.</p> <p>Variables: <resolution.refresh> varients = VIC list in EDID source and default prefer resolution is the EDID source's prefer resolution</p>	<p>Command: SEND_COMMAND VIDEO_INPUT_1,"?VIDIN_PREF_EDID"</p> <p>Return: VIDIN_PREF_EDID-1920x1200,60</p> <p>Description: The preferred resolution of the EDID source for HDMI input is 1920x1200@60Hz.</p>

NO.	Description	Command	Example
9	VIDIN_HDR	<p>Command: SEND_COMMAND <DEV>,""VIDIN_HDR-<HDR10 NONE>"</p> <p>Return: VIDIN_HDR-<HDR10 NONE></p> <p>Description: Set Input EDID to support HDR10 or NONE.</p> <p>Variables:</p> <ul style="list-style-type: none"> NONE (Default): no HDR is supported HDR10: support HDR10 in EDID 	<p>Command: SEND_COMMAND dvTX,""VIDIN_HDR-HDR10""</p> <p>Return: VIDIN_HDR-HDR10</p> <p>Description: Set input EDID with HDR10 video support to be enabled.</p>
10	?VIDIN_HDR	<p>Command: SEND_COMMAND <DEV>,""?VIDIN_HDR""</p> <p>Return: VIDIN_HDR-<HDR10 NONE></p> <p>Description: Get Input EDID's configurate for HDR support.</p>	<p>Command: SEND_COMMAND dvTX,""?VIDIN_HDR""</p> <p>Return: VIDIN_HDR-HDR10</p> <p>Description: Current input EDID for video input port is with HDR10 video supported.</p>
11	VIDIN_EDID_DATA	<p>Command: SEND_COMMAND <DEV>,""VIDIN_EDID_DATA-<edid>"</p> <p>Return: VIDIN_EDID_DATA-<edid></p> <p>Description: Upload User Defined EDID for video input port under manual mode.</p> <p>Variables: edid = 256byte EDID in HEX value</p>	<p>Command: SEND_COMMAND dvRX,""VIDIN_EDID_DATA-00 FF FF FF FF FF FF 00 05 B8 00 11 04 00 00 00 1C 19 01 03 80 00 00 78 0E EE 95 A3 54 4C 99 26 0F 50 54 FF FF 80 D1 00 B3 00 A9 40 81 00 81 C0 81 80 8B C0 95 00 02 3A 80 18 71 38 2D 40 58 2C 45 00 40 84 63 00 00 1E 00 00 00 FC 00 41 4D 58 5F 48 44 4D 49 31 76 34 0A 20 00 00 00 FD 00 17 78 0F 66 11 00 0A 20 20 20 20 00 00 00 00 FA 00 D1 C0 A9 C0 90 40 81 40 01 01 01 01 0A 01 5F 02 03 30 70 67 03 0C 00 11 00 80 22 5F 10 20 22 1F 21 05 14 04 03 13 02 0E 0F 11 06 07 12 15 16 1D 1E 27 29 2A 2B 2C 2D 2F 30 31 01 23 09 07 07 1A 36 80 A0 70 38 1F 40 30 20 35 00 40 84 63 00 00 1A 46 37 80 70 72 38 22 40 70 C8 35 00 40 84 63 00 00 1C D1 3D 80 80 72 B0 26 40 78 C8 36 00 40 E8 63 00 00 1C 28 3C 80 A0 70 B0 23 40 30 20 36 00 40 E8 63 00 00 1A 00 00 00 00 00 00 45</p> <p>Return: VIDIN_EDID_DATA-00 FF FF FF FF FF FF 00 05 B8 00 11 04 00 00 00 1C 19 01 03 80 00 00 78 0E EE 95 A3 54 4C 99 26 0F 50 54 FF FF 80 D1 00 B3 00 A9 40 81 00 81 C0 81 80 8B C0 95 00 02 3A 80 18 71 38 2D 40 58 2C 45 00 40 84 63 00 00 1E 00 00 00 FC 00 41 4D 58 5F 48 44 4D 49 31 76 34 0A 20 00 00 00 FD 00 17 78 0F 66 11 00 0A 20 20 20 20 00 00 00 00 FA 00 D1 C0 A9 C0 90 40 81 40 01 01 01 01 0A 01 5F 02 03 30 70 67 03 0C 00 11 00 80 22 5F 10 20 22 1F 21 05 14 04 03 13 02 0E 0F 11 06 07 12 15 16 1D 1E 27 29 2A 2B</p>

NO.	Description	Command	Example
			<p>2C 2D 2F 30 31 01 23 09 07 07 1A 36 80 A0 70 38 1F 40 30 20 35 00 40 84 63 00 00 1A 46 37 80 70 72 38 22 40 70 C8 35 00 40 84 63 00 00 1C D1 3D 80 80 72 B0 26 40 78 C8 36 00 40 E8 63 00 00 1C 28 3C 80 A0 70 B0 23 40 30 20 36 00 40 E8 63 00 00 1A 00 00 00 00 00 00 00 45</p> <p>Description: Upload User Defined EDID for video input port EDID under manual mode.</p>
12	?VIDIN_EDID_DATA	<p>Command: SEND_COMMAND <DEV>,""?VIDIN_EDID_DATA"</p> <p>Return: VIDIN_EDID_DATA-<edid></p> <p>Description: Download current Active EDID in Transmitter under AUTO or Manual mode.</p> <p>Variables: EDID = 256byte EDID in HEX value</p>	<p>Command: SEND_COMMAND dvTX,""?VIDIN_EDID_DATA</p> <p>Return: VIDIN_EDID_DATA-00 FF FF FF FF FF FF 00 05 B8 00 11 04 00 00 00 1C 19 01 03 80 00 00 78 0E EE 95 A3 54 4C 99 26 0F 50 54 FF FF 80 D1 00 B3 00 A9 40 81 00 81 C0 81 80 8B C0 95 00 02 3A 80 18 71 38 2D 40 58 2C 45 00 40 84 63 00 00 1E 00 00 00 FC 00 41 4D 58 5F 48 44 4D 49 31 76 34 0A 20 00 00 00 FD 00 17 78 0F 66 11 00 0A 20 20 20 20 20 20 00 00 00 FA 00 D1 C0 A9 C0 90 40 81 40 01 01 01 01 0A 01 5F 02 03 30 70 67 03 0C 00 11 00 80 22 5F 10 20 22 1F 21 05 14 04 03 13 02 0E 0F 11 06 07 12 15 16 1D 1E 27 29 2A 2B 2C 2D 2F 30 31 01 23 09 07 07 1A 36 80 A0 70 38 1F 40 30 20 35 00 40 84 63 00 00 1A 46 37 80 70 72 38 22 40 70 C8 35 00 40 84 63 00 00 1C D1 3D 80 80 72 B0 26 40 78 C8 36 00 40 E8 63 00 00 1C 28 3C 80 A0 70 B0 23 40 30 20 36 00 40 E8 63 00 00 1A 00 00 00 00 00 00 00 45</p> <p>Description: Download current active EDID in Transmitter.</p>
13	VIDIN_HDCP	<p>Command: SEND_COMMAND <DEV>, "?VIDIN_HDCP- <ENABLE DISABLE>"</p> <p>Return: VIDIN_HDCP-<ENABLE DISABLE></p> <p>Description: Set HDCP compliance of the specified video input port.</p>	<p>Command: SEND_COMMAND VIDEO_INPUT_1,"?VIDIN_HDCP-ENABLE"</p> <p>Return: VIDIN_HDCP-ENABLE</p> <p>Description: Set HDMI IN HDCP2.2 Compliant to be enabled.</p>
14	?VIDIN_HDCP	<p>Command: SEND_COMMAND <DEV>,""?VIDIN_HDCP"</p> <p>Return: VIDIN_HDCP-<ENABLE DISABLE></p> <p>Description: Get HDCP compliance setting of the specified video input port.</p>	<p>Command: SEND_COMMAND VIDEO_INPUT_1,"?VIDIN_HDCP"</p> <p>Return: VIDIN_HDCP-ENABLE</p> <p>Description: HDMI IN HDCP2.2 Compliant is ENABLE.</p>

NO.	Description	Command	Example
15	VIDIN_FORMAT	Command: SEND_COMMAND <DEV>,"VIDIN_FORMAT-< HDMI DVI >" Return: VIDIN_FORMAT-< HDMI DVI > Description: Set the video format on the Transmitter	Command: SEND_COMMAND VIDEO_INPUT_1,"VIDIN_FORMAT-DVI" Return: VIDIN_FORMAT-DVI Description: Set DVI format to HDMI Input port.
16	?VIDIN_FORMAT	Command: SEND_COMMAND <DEV>,"?VIDIN_FORMAT" Return: VIDIN_FORMAT-< HDMI DVI > Description: Request the video format on the Transmitter HDMI Input port.	Command: SEND_COMMAND VIDEO_INPUT_1,"?VIDIN_FORMAT" Return: VIDIN_FORMAT-DVI Description: HDMI IN port is set to DVI format.
Video SEND_COMMANDs are sent to Port 9			
17	VIDOUT_MUTE	Command: SEND_COMMAND <DEV>,"VIDOUT_MUTE-<ENABLE DISABLE>" Return: VIDOUT_MUTE<ENABLE DISABLE> Description: Set the Mute preference of the image for HDMI Loop out.	Command: SEND_COMMAND SWITCHER,"VIDOUT_MUTE-ENABLE" Return: VIDOUT_MUTE-ENABLE Description: Set Video mute mode to "enable".
18	?VIDOUT_MUTE	Command: SEND_COMMAND <DEV>,"?VIDOUT_MUTE" Return: VIDOUT_MUTE<ENABLE DISABLE> Description: Requests the setting for the Mute preference applied to the image from HDMI Loop out.	Command: SEND_COMMAND SWITCHER,"?VIDOUT_MUTE" Return: VIDOUT_MUTE-DISABLE Description: Video mute mode is set to disable.
Video SEND_COMMANDs are sent to Port 6			
19	VIDOUT_SCALE	Command: SEND_COMMAND <DEV>,"VIDOUT_SCALE-<mode>" Return: VIDOUT_SCALE-<mode> Description: Set the Scaling Mode on the Transmitter. Variables: mode = BYPASS, DOWNSTREAM	Command: SEND_COMMAND VIDEO_OUTPUT_1,"VIDOUT_SCALE-AUTO" Return: VIDOUT_SCALE-DOWNSTREAM Description: Set scaler mode to downstream.

NO.	Description	Command	Example
20	?VIDOUT_SCALE	<p>Command: SEND_COMMAND <DEV>,""?VIDOUT_SCALE"</p> <p>Return: VIDOUT_SCALE-<mode></p> <p>Description: Requests the current Scaling Mode that the Transmitter is set to.</p> <p>Variables: mode = BYPASS, DOWNSTREAM</p>	<p>Command: SEND_COMMAND VIDEO_OUTPUT_1,""?VIDOUT_SCALE"</p> <p>Return: VIDOUT_SCALE-BYPASS</p> <p>Description: Scaler mode is set to Bypass.</p>
CEC SEND_COMMANDs are sent to Port 6 and Port 9			
21	VIDOUT_CEC_POWER	<p>Command: SEND_COMMAND <DEV>,"VIDOUT_CEC_POWER-<ON OFF>"</p> <p>Return: VIDOUT_CEC_POWER-<ON OFF></p> <p>Description: Set power status to on/off on the sink display.</p>	<p>Command: SEND_COMMAND dxTX,"VIDOUT_CEC_POWER-OFF"</p> <p>Return: VIDOUT_CEC_POWER-OFF</p> <p>Description: Set power status to OFF on sink display.</p>
22	?VIDOUT_CEC_POWER	<p>Command: SEND_COMMAND <DEV>,"?VIDOUT_CEC_POWER"</p> <p>Return: VIDOUT_CEC_POWER-<state></p> <p>Description: Request the current power status from the TV via CEC.</p> <p>Variables: state = { ON, OFF, WARMUP, COOLDOWN }</p>	<p>Command: SEND_COMMAND dxTX,"?VIDOUT_CEC_POWER"</p> <p>Return: VIDOUT_CEC_POWER-OFF</p> <p>Description: Current power status from sink TV is power off.</p>
23	VIDOUT_CEC_SYS_STANDBY	<p>Command: SEND_COMMAND <DEV>,"VIDOUT_CEC_SYS_STANDBY"</p> <p>Return: VIDOUT_CEC_SYS_STANDBY</p> <p>Description: Set all devices connected to the HDMI output to Standby mode.</p>	<p>Command: SEND_COMMAND dxTX,"VIDOUT_CEC_SYS_STANDBY"</p> <p>Return: VIDOUT_CEC_SYS_STANDBY</p> <p>Description: Set all devices connected to the HDMI output to Standby mode.</p>

NO.	Description	Command	Example
24	VIDOUT_CEC_MAKE ACTIVE	<p>Command: SEND_COMMAND <DEV>,"VIDOUT_CEC_MAKEACTIVE"</p> <p>Return: VIDOUT_CEC_MAKEACTIVE</p> <p>Description: Set sink TV to turn on and make this HDMI to be connected the active source.</p>	<p>Command: SEND_COMMAND dxTX,"VIDOUT_CEC_MAKEACTIVE"</p> <p>Return: VIDOUT_CEC_MAKEACTIVE</p> <p>Description: Set sink TV to turn on and make this HDMI to be connected to the active source.</p>
25	CEC_DISP_AUTO	<p>Command: SEND_COMMAND <DEV>,"CEC_DISP_AUTO-<ON OFF>"</p> <p>Return: 'CEC_DISP_AUTO-<ON OFF></p> <p>Description: Set power control of sink display automatically according to the detected active input signal and its own power boot-up state.</p>	<p>Command: SEND_COMMAND dxTX,"CEC_DISP_AUTO-OFF"</p> <p>Return: CEC_DISP_AUTO-OFF</p> <p>Description: Set the function to OFF for power control of sink display automatically.</p>
26	?CEC_DISP_AUTO	<p>Command: SEND_COMMAND <DEV>,""?CEC_DISP_AUTO"</p> <p>Return: CEC_DISP_AUTO-<ON OFF></p> <p>Description: Get the configuration for power control of sink display automatically.</p>	<p>Command: SEND_COMMAND dvTX,""?CEC_DISP_AUTO"</p> <p>Return: CEC_DISP_AUTO-ON</p> <p>Description: The configuration for power control of sink display automatically is ON.</p>
27	CEC_SLEEP_TIMEOUT	<p>Command: SEND_COMMAND <DEV>,"CEC_SLEEP_TIMEOUT-<time>"</p> <p>Return: CEC_SLEEP_TIMEOUT-<time></p> <p>Description: Set Delay Time to control sink display power automatically.</p> <p>Variables: time: {1 ~ 30} minutes</p>	<p>Command: SEND_COMMAND dvTX,"CEC_SLEEP_TIMEOUT-5"</p> <p>Return: CEC_SLEEP_TIMEOUT-5</p> <p>Description: Set Delay Time to 5 Minutes</p>
28	?CEC_SLEEP_TIMEOUT	<p>Command: SEND_COMMAND <DEV>,""?CEC_SLEEP_TIMEOUT"</p> <p>Return: CEC_SLEEP_TIMEOUT-<time></p> <p>Description: Gets Delay Time to control sink display power on/off automatically.</p> <p>Variables: time: {1 ~ 30} minutes</p>	<p>Command: SEND_COMMAND dvTX,""?CEC_SLEEP_TIMEOUT"</p> <p>Return: CEC_SLEEP_TIMEOUT-5</p> <p>Description: The Delay Time to control sink display power on/off automatically according to the detected active input signal or its own power boot-up state is 5 minutes.</p>

NO.	Description	Command	Example
Audio SEND_COMMANDs are sent to Port 7			
29	AUDIN_DIGITAL	<p>Command: SEND_COMMAND <DEV>,"AUDIN_DIGITAL-<format>"</p> <p>Return: AUDIN_DIGITAL-<format></p> <p>Description: Set the audio format of EDID for the specified Audio input port.</p> <p>Variables: format = { BASIC (Default), PCM-2CH, PCM-8CH, DOLBY DIGITAL, DTS, MPEG, AAC, TRUEHD, DTSHD, ATMOS, DOLBY DIGITAL PLUS }</p>	<p>Command: SEND_COMMAND dvTX,"AUDIN_DIGITAL-AC3"</p> <p>Return: AUDIN_DIGITAL- AAC</p> <p>Description: Set audio format of input EDID to AAC Audio compression format.</p>
30	?AUDIN_DIGITAL	<p>Command: SEND_COMMAND <DEV>,"?AUDIN_DIGITAL"</p> <p>Return: AUDIN_DIGITAL-<format></p> <p>Description: Get the audio format in EDID for the specified Audio input port.</p> <p>Variables: format = { BASIC (Default), PCM-2CH, PCM-8CH, DOLBY DIGITAL, DTS, MPEG, AAC, TRUEHD, DTSHD, ATMOS, DOLBY DIGITAL PLUS }</p>	<p>Command: SEND_COMMAND dvTX,"?AUDIN_DIGITAL"</p> <p>Return: AUDIN_DIGITAL- AAC</p> <p>Description: The audio format in input EDID is AAC Audio compression.</p>

NO.	Description	Command	Example
31	AUDIN_FORMAT_AUTO	<p>Command: SEND_COMMAND <DEV>, ""AUDIN_FORMAT_AUTO-<ENABLE DISABLE>""</p> <p>Return: AUDIN_FORMAT_AUTO-<ENABLE DISABLE></p> <p>Description: Set audio source format to automatically detect the audio through the TX.</p> <p>Variables:</p> <ul style="list-style-type: none"> • ENABLE (Default) - automatically detect and select the HDMI Embedded Audio or External Analog Audio • DISABLE - manual define the audio source priority by AUDIN_FORMAT 	<p>Command: SEND_COMMAND VIDEO_IN_1, ""AUDIN_FORMAT_AUTO-ENABLE""</p> <p>Return: AUDIN_FORMAT_AUTO-ENABLE</p> <p>Description: Auto detecting and selecting the audio source between HDMI Embedded Audio or External Analog audio is set to enable.</p>
32	?AUDIN_FORMAT_AUTO	<p>Command: SEND_COMMAND <DEV>, ""?AUDIN_FORMAT_AUTO""</p> <p>Return: AUDIN_FORMAT_AUTO-<ENABLE DISABLE></p> <p>Description: Request the setting for automatically detecting the audio source format through the TX.</p>	<p>Command: SEND_COMMAND VIDEO_IN_1, ""?AUDIN_FORMAT_AUTO""</p> <p>Return: AUDIN_FORMAT_AUTO-ENABLE</p> <p>Description: Auto detecting the audio source from HDMI Embedded Audio or External Analog audio is set to enable.</p>
33	AUDIN_FORMAT	<p>Command: SEND_COMMAND <DEV>, ""AUDIN_FORMAT-<format>""</p> <p>Return: AUDIN_FORMAT-<format></p> <p>Description: Select the audio input source that will be embedded on the HDMI signal through the TX.</p> <p>Variables: format = { HDMI (Default) ANALOG, }</p>	<p>Command: SEND_COMMAND VIDEO_IN_1, ""AUDIN_FORMAT-HDMI""</p> <p>Return: AUDIN_FORMAT-HDMI</p> <p>Description: Set the order of precedence Audio source to be (HDMI embedded audio, Analog), that to say, if there is input audio both HDMI INPUT and AUDIO IN, the priority of active audio is HDMI Embedded, second is External analog audio.</p>
34	?AUDIN_FORMAT	<p>Command: SEND_COMMAND <DEV>, ""?AUDIN_FORMAT""</p> <p>Return: AUDIN_FORMAT-<format></p> <p>Description: Request the setting for the audio source format.</p>	<p>Command: SEND_COMMAND VIDEO_IN_1, ""?AUDIN_FORMAT""</p> <p>Return: AUDIN_FORMAT-HDMI</p> <p>Description: The order of precedence Audio source is (HDMI embedded audio, Analog).</p>

NO.	Description	Command	Example
		Variables: format = { HDMI (Default) ANALOG, }	
IR SEND_COMMANDs are sent to Port 3 (IR TX port)			
	channel	Function	
	1-255	Generate the IR or serial command assigned to that channel	
35	CAROFF	Command: SEND_COMMAND <DEV>,"CAROFF" Return: CAROFF Description: Disable the IR carrier signal until a 'CARON' Send Command is received.	Command: SEND_COMMAND IR_1,"CAROFF" Return: CAROFF
36	CARON	Command: SEND_COMMAND <DEV>,"CARON" Return: CARON Description: Enable the IR carrier signals (default).	Command: SEND_COMMAND IR_1,"CARON" Return: CARON
37	CH	Command: SEND_COMMAND <DEV>,"CH",<channel number>" Description: Send IR pulses for the selected channel. Variables: Valid response: channel number = 0 to 199 channels All channels below 100 are transmitted as two digits. If the IR code for ENTER (function #21) is loaded, an Enter will follow the number. If the channel is greater than or equal to (>=) 100, then IR function 127 or 20 (whichever exists) is generated for the one hundred digit. The IR port on the DXLink RX performs the following: Transmits IR signals for 1 (IR code 11). The transmit time is set with the CTON command. Waits until the time set with the CTOF command elapses. Transmits IR signals for 8 (IR code 18). Waits for the time set with the CTOF command to elapse. If the IR code for Enter (IR code 21) is	Command: SEND_COMMAND IR_1,"CH",18"

NO.	Description	Command	Example
		programmed, the module performs the following steps: Transmits IR signals for Enter (IR code 21). Waits for the time set with the CTOF command to elapse.	
38	CP	<p>Command: SEND_COMMAND <DEV>,"CP',<code>"</p> <p>Description: Halt and clear all active or buffered IR commands, and then send a single IR pulse.</p> <p>Variables: Valid response: code = IR port's channel value 0 to 252 (253 to 255 reserved).</p>	<p>Command: SEND_COMMAND IR_1,"CP',2"</p>
39	CTOF	<p>Command: SEND_COMMAND <DEV>,"CTOF',<time>"</p> <p>Description: Set the duration of the Off time (no signal) between IR pulses for channel and IR function transmissions. Off time settings are stored in non-volatile memory. This command sets the delay time between pulses generated by the 'CH' or 'XCH' send commands in tenths of seconds.</p> <p>Variables: Valid response: time = 0 to 255. Given in 1/10th of a second increments. Default is 5 (0.5 seconds).</p>	<p>Command: SEND_COMMAND IR_1,"CTOF',10"</p>
40	CTON	<p>Command: SEND_COMMAND <DEV>,"CTON',<time>"</p> <p>Description: Set the total time of IR pulses transmitted and is stored in nonvolatile memory. This command sets the pulse length for each pulse generated by the 'CH' or 'XCH' send commands in tenths of seconds.</p> <p>Variables: This command sets the pulse length for each pulse generated by the 'CH' (see previous page) or 'XCH' (see next page) Send Commands in tenth of a second increments. Valid response: time = 0 to 255. Given in 1/10th of a second increments. Default is 5 (0.5 seconds).</p>	<p>Command: SEND_COMMAND IR_1,"CTON',20"</p>

NO.	Description	Command	Example
41	GET BAUD	<p>Command: SEND_COMMAND <DEV>,"GET BAUD"</p> <p>Description: Get the IR port's current communication parameters.</p>	<p>Command: SEND_COMMAND dvRXRS232,"GET BAUD"</p> <p>Description: The port responds with: Port <port #>, <baud>, <parity>, <data>, <stop></p>
42	GET MODE	<p>Command: SEND_COMMAND <DEV>,"GET MODE"</p> <p>Description: The port responds with: <port #> <mode>, <carrier>, <io link channel>.</p> <p>Description: Poll the IR/Serial port's configuration parameters and report the active mode settings to the device requesting the information. NOTE: Works with Port 3 only.</p>	<p>Command: SEND_COMMAND IR_1,"GET MODE"</p> <p>Description: The system could respond with: PORT 3 IR, CARRIER, IO LINK 0</p>
43	IROFF	<p>Command: SEND_COMMAND <DEV>,"IROFF"</p> <p>Description: Halt and clear all active or buffered IR commands being output on the designated port.</p>	<p>Command: SEND_COMMAND IR_1,"IROFF"</p> <p>Description: Immediately halt and clear all IR output signals on the IR_1 port.</p>
44	SET BAUD	<p>Command: SEND_COMMAND <DEV>,"SET BAUD <baud>,<parity>,<data>, <stop>"</p> <p>Description: Set the IR port's DATA mode communication parameters. Only valid if the port is in Data Mode</p> <p>Variables: baud = baud rates are: 19200 (Serial only), 9600, 4800, 2400, 1200, 600 (IR only), 300 (IR only), 150 (IR only)</p> <p>parity = N (none), O (odd), E (even), M (mark), S (space). data = 7 or 8 data bits. stop = 1 and 2 stop bits.</p> <p>NOTE: The only valid 9-bit combination is (baud), N, 9, 1.</p>	<p>Command: SEND_COMMAND DEVICE_1,"SET BAUD 1200,N,8,1"</p>
45	SET MODE	<p>Command: SEND_COMMAND <DEV>,"SET MODE'<mode>"</p> <p>Return: SET MODE'<mode></p> <p>Description:</p>	<p>Command: SEND_COMMAND IR_1,"SET MODE IR"</p> <p>Description: Set the IR_1 port to IR mode for IR control.</p>

NO.	Description	Command	Example
		<p>Set the IR/Serial ports for IR or Serial-controlled devices to either IR, Serial, or Data mode.</p> <p>Variables: Valid response: mode = IR (standard IR output with carrier) SERIAL (IR without carrier and waveform inverted) DATA (1-way serial/TTL)</p>	
46	SP	<p>Command: SEND_COMMAND <DEV>,"SP',<code>"</p> <p>Description: Generate a single IR pulse. You can use the CTON to set pulse lengths and the CTOF for time Off between pulses.</p> <p>Variables: Valid response: code = IR code value 1 to 252 (253 to 255 reserved).</p>	<p>Command: SEND_COMMAND IR_1,"SP',25"</p> <p>Description: Pulses IR code 25 on IR port on RX.</p>
47	XCH	<p>Command: SEND_COMMAND <DEV>,"XCH <channel>"</p> <p>Description: Transmit the selected channel IR codes in the format/pattern set by the XCHM command.</p> <p>Variables: Valid response: channel = 0 to 999.</p>	<p>Command: SEND_COMMAND IR_1,"XCH,30"</p> <p>Return: XCH 30</p>
48	XCHM	<p>Command: SEND_COMMAND <DEV>,"XCHM <extended channel mode>"</p> <p>Return: XCHM <extended channel mode></p> <p>Description: Change the IR output pattern for the 'XCH' Send Command.</p> <p>Variables: Valid response: extended channel mode = 0 to 4.</p>	<p>Command: SEND_COMMAND IR_1,"XCHM 3"</p> <p>Return: XCHM 3</p> <p>Description: Set the IR device's extended channel command to mode 3.</p>
49	B9MOFF	<p>Command: B9MOFF</p> <p>Description: Set the port's communication parameters for stop and data bits according to the software settings on the RS-232 port. (Default).</p> <p>Variables: This command works in conjunction with</p>	<p>Command: SEND_COMMAND SOMEDEVICE_1,"B9MOFF"</p> <p>Description: Sets the port settings on SOMEDEVICE to match the port's configuration settings.</p>

NO.	Description	Command	Example
		the 'B9MON' command. Disables 9-bit in 232 mode. By default, this returns the Communication settings on the serial port to the last programmed parameters.	
50	B9MON	<p>Command: B9MON</p> <p>Description Override and set the current communication settings and parameters on the RS-232 serial port to 9 data bits with one stop bit.</p> <p>Variables: This command works in conjunction with the 'B9MOFF' command. Enables 9-bit in 232 mode.</p>	<p>Command: SEND_COMMAND SOMEDEVICE_1,"B9MON"</p> <p>Description: Reset the SOMEDEVICE port's communication parameters to nine data bits and one stop bit.</p>
51	CHARD	<p>Command: SEND_COMMAND <DEV>,"CHARD- <time>"</p> <p>Description: Set the delay time among all transmitted characters to the value specified (in 100 microsecond increments).</p> <p>Variables: Valid response: time = 0 to 10000 (1 second)</p>	<p>Command: SEND_COMMAND dvRXRS232,"CHARD-10"</p> <p>Description: Set the delay time to a 1-millisecond delay among all transmitted characters.</p>
52	CHARDM	<p>Command: SEND_COMMAND <DEV>,"CHARDM- <time>"</p> <p>Description: Set the delay time among all transmitted characters to the value specified (in 1 millisecond increments).</p> <p>Variables: Valid response: time = 0 to 1000 (1 second)</p>	<p>Command: SEND_COMMAND dvRXRS232,"CHARDM-10"</p> <p>Description: Set the delay time to 10-millisecond among all transmitted characters.</p>
53	ESCSEQOFF	<p>Command: SEND_COMMAND <DEV>,"ESCSEQOFF"</p> <p>Description: Disable SEND_STRING escape sequences (Default).</p>	<p>Command: SEND_COMMAND dvRX,"ESCSEQOFF"</p> <p>Description: Disable SEND_STRING escape sequences (see the "SEND_STRING Escape Sequences" section).</p>

NO.	Description	Command	Example
54	ESCSEQON	<p>Command: SEND_COMMAND <DEV>,"ESCSEQON"</p> <p>Description: Enables SEND_STRING escape sequences.</p>	<p>Command: SEND_COMMAND dvRX,"ESCSEQON"</p> <p>Description: Enable SEND_STRING escape sequences (see the "SEND_STRING Escape Sequences" section).</p>
55	GET BAUD	<p>Command: SEND_COMMAND <DEV>,"GET BAUD"</p> <p>Description: Get the RS-232 (serial) port's current communication parameters.</p>	<p>Command: SEND_COMMAND dvRXRS232,"GET BAUD"</p> <p>Description: The port responds with: Port <port> #>,<baud>,<parity>,<data>,<stop></p>
56	RXCLR	<p>Command: SEND_COMMAND <DEV>,"RXCLR"</p> <p>Description: Clear all characters in the receive buffer waiting to be sent to the Central Controller.</p>	<p>Command: SEND_COMMAND dvRXRS232,"RXCLR"</p> <p>Description: Clear all characters in the receive buffer waiting to be sent to the Central Controller.</p>
57	RXOFF	<p>Command: SEND_COMMAND <DEV>,"RXOFF"</p> <p>Description: Disable the transmission of incoming received characters to the Central Controller (default).</p>	<p>Command: SEND_COMMAND dvRXRS232,"RXOFF"</p> <p>Description: Disables the transmission of incoming received characters to the Central Controller.</p>
58	RXON	<p>Command: SEND_COMMAND <DEV>,"RXON"</p> <p>Description: Start transmitting received characters to the Central Controller. Enables sending incoming received characters to the Central Controller.</p> <p>This command is automatically sent by the Central Controller when a 'CREATE_BUFFER' program instruction is executed.</p>	<p>Command: SEND_COMMAND dvRXRS232,"RXON"</p> <p>Description: Sets the RX RS-232 port to transmit received characters to the Central Controller.</p>
59	TXCLR	<p>Command: SEND_COMMAND <DEV>,"TXCLR"</p> <p>Description: Stop and clear all characters waiting in the transmit out buffer and stops transmission.</p>	<p>Command: SEND_COMMAND dvRXRS232,"TXCLR"</p> <p>Description: Stop and clear all characters waiting in the RX serial port's transmit buffer.</p>

NO.	Description	Command	Example
60	SET BAUD (shown in s) Or TSET BAUD	<p>Command: SEND_COMMAND <DEV>,"SET BAUD <baud>,<parity>,<data>, <stop>"</p> <p>Description: Use either of these commands to set the serial communication parameters.</p> <p>NOTE: DXLink Receivers only support RS-232 serial communication.</p> <p>Variables: Valid responses: baud = 115200, 76800, 57600, 38400, 19200, 9600, 4800, 2400, 1200, 600, 300, 150. parity = N (none), O (odd), E (even), M (mark), S (space) data = 7 or 8 data bits stop = 1 or 2 stop bits</p>	<p>Command: SEND_COMMAND DEVICE_1,"SET BAUD 115200,N,8,1"</p> <p>Description: Set the DEVICE_1 port's communication parameters to 115,200 baud, no parity, 8 data bits, and 1 stop bit.</p>
SEND_STRING Escape Sequences are sent to Port 1			
<p>The DXLink Modules support several special SEND_STRING escape sequences. If any of the character combinations listed below are found anywhere within a SEND_STRING program instruction, they will be treated as a command and not the literal characters.</p> <p>Use the ESCSEQON and ESCSEQOFF NetLinx SEND_COMMANDS to control whether these are active or not. The ESCSEQON command must precede the Escape Sequences, otherwise strings will be processed normally. These commands are sent to Port 1.</p>			
61	27,17	<p>Command: SEND_COMMAND <DEV>,"27,17,<time>"</p> <p>Description: Send a break character for a specified duration to a specific device.</p> <p>Variables: time = 1 to 255 (measured in 100 microsecond increments)</p>	<p>Command: SEND_COMMAND RS232_1,"27,17,10"</p> <p>Description: Send a break character of 1 millisecond to the RS232_1 device.</p>
62	27, 18, 0	<p>Command: SEND_COMMAND <DEV>,"27,18,0"</p> <p>Description: Clear the ninth data bit by setting it to 0 on all character transmissions.</p> <p>Used in conjunction with the 'B9MON' command</p>	<p>Command: SEND_COMMAND RS232_1,"27,17,0"</p> <p>Description: Set the RS232_1 device's ninth data bit to 0 on all character transmissions.</p>
63	27, 18, 1	<p>Command: SEND_COMMAND <DEV>,"27,18,1"</p> <p>Description: Set the ninth data bit to 1 for all subsequent characters to be transmitted.</p> <p>Used in conjunction with the 'B9MON' command</p>	<p>Command: SEND_COMMAND RS232_1,"27,17,1"</p> <p>Description: Set the RS232_1 device's ninth data bit to 1 on all character transmissions.</p>

NO.	Description	Command	Example
64	27, 19	<p>Command: SEND_COMMAND <DEV>,""27,19,<time>""</p> <p>Description: Insert a time delay before transmitting the next character</p> <p>Variables: time = 1 to 255, (measured in 1 millisecond increments)</p>	<p>Command: SEND_COMMAND RS232_1,""27,19,10""</p> <p>Description: Insert a 10-millisecond delay before transmitting characters to the RS232_1 device.</p>

DX-RX-4K60

NO	Description	Command	Example
Video SEND_COMMANDs are sent to Port 6			
1	VIDOUT_ASPECT_RATIO	<p>Command: SEND_COMMAND <DEV>,""VIDOUT_ASPECT_RATIO-<ratio>""</p> <p>Return: VIDOUT_ASPECT_RATIO-<ratio></p> <p>Description: Set the aspect ratio preference of the video through the Receiver to Stretch, Maintain, or Anamorphic.</p> <p>Variables: ratio = MAINTAIN, STRETCH</p>	<p>Command: SEND_COMMAND dvRX,""VIDOUT_ASPECT_RATIO-STRETCH""</p> <p>Return: VIDOUT_ASPECT_RATIO-STRETCH</p> <p>Description: Set Scaler Output video aspect to stretch. Input Video aspect to fix display aspect.</p>
2	?VIDOUT_ASPECT_RATIO	<p>Command: SEND_COMMAND <DEV>,""?VIDOUT_ASPECT_RATIO""</p> <p>Return: VIDOUT_ASPECT_RATIO-<ratio></p> <p>Description: Request the aspect ratio preference of the video through the Receiver.</p> <p>Variables: ratio = MAINTAIN, STRETCH</p>	<p>Command: SEND_COMMAND dvRX,""?VIDOUT_ASPECT_RATIO""</p> <p>Return: VIDOUT_ASPECT_RATIO-MAINTAIN</p> <p>Description: Current Scaler Output video aspect is set to MAINTAIN, stay the same with input video.</p>
3	VIDOUT_TESTPAT	<p>Command: SEND_COMMAND <DEV>,""VIDOUT_TESTPAT-<pattern>""</p> <p>Return: VIDOUT_TESTPAT-<pattern></p> <p>Description: Set the test pattern to display. Can be sent in any Scaling Mode.</p>	<p>Command: SEND_COMMAND dvRX,""VIDOUT_TESTPAT-RED""</p> <p>Return: VIDOUT_TESTPAT-RED</p> <p>Description: Sets the test pattern on the video output to RED pattern and Enable.</p>

NO	Description	Command	Example
		Variables: Valid responses: pattern = OFF, RED, GREEN, BLUE	
4	?VIDOUT_TESTPAT	Command: SEND_COMMAND <DEV>,""?VIDOUT_TESTPAT" Return: VIDOUT_TESTPAT-<pattern> Description: Request the test pattern setting on the Receiver. Variables: Valid responses: pattern = OFF, RED, GREEN, BLUE	Command: SEND_COMMAND dvRX,""?VIDOUT_TESTPAT" Return: VIDOUT_TESTPAT-RED Description: The test pattern setting on the video output is RED pattern and Test pattern is set to Enable.
5	VIDOUT_BLANK	Command: SEND_COMMAND <DEV>,""VIDOUT_BLANK-<pattern>" Return: VIDOUT_BLANK-<pattern> Description: Set the image setting of the video blanking for the specified video port. Variables: Valid responses: pattern = BLACK, BLUE, LOGO1, LOGO2, LOGO3	Command: SEND_COMMAND dvRX,""VIDOUT_BLANK-BLUE" Return: VIDOUT_BLANK-BLUE Description: Set the blank pattern on the video output to blue pattern.
6	?VIDOUT_BLANK	Command: SEND_COMMAND <DEV>,""?VIDOUT_BLANK" Return: VIDOUT_BLANK-<pattern> Description: Request the image setting of the video blanking for the specified video port Variables: Valid responses: pattern = BLACK, BLUE, LOGO1, LOGO2, LOGO3	Command: SEND_COMMAND dvRX,""?VIDOUT_BLANK" Return: VIDOUT_BLANK-BLUE Description: The image setting on the video output is BLUE pattern.

NO	Description	Command	Example
7	VIDOUT_LOGO	<p>Command: SEND_COMMAND <DEV>,""VIDOUT_LOGO-<mode>""</p> <p>Return: VIDOUT_LOGO-<mode></p> <p>Description: Set the LOGO move mode of the video blanking for the specified video port</p> <p>Variables: Valid responses: mode = FIX IN CENTER, DRAG TOP LEFT, DRAG TOP RIGHT, DRAG BOTTOM LEFT, DRAG BOTTOM RIGHT</p>	<p>Command: SEND_COMMAND dvRX,""VIDOUT_LOGO-DRAG BOTTOM LEFT""</p> <p>Return: VIDOUT_LOGO-DRAG BOTTOM LEFT</p> <p>Description: Set the LOGO move mode from Center to bottom left.</p>
8	?VIDOUT_LOGO	<p>Command: SEND_COMMAND <DEV>,""?VIDOUT_LOGO""</p> <p>Return: VIDOUT_LOGO-<mode></p> <p>Description: Set the LOGO move mode of the video blanking for the specified video port</p> <p>Variables: Valid responses: mode = FIX IN CENTER, DRAG TOP LEFT, DRAG TOP RIGHT, DRAG BOTTOM LEFT, DRAG BOTTOM RIGHT</p>	<p>Command: SEND_COMMAND dvRX,""?VIDOUT_LOGO""</p> <p>Return: VIDOUT_LOGO-DRAG BOTTOM LEFT</p> <p>Description: LOGO move mode setting is from Center to bottom left.</p>
9	VIDOUT_SCALE	<p>Command: SEND_COMMAND <DEV>,""VIDOUT_SCALE-<mode>""</p> <p>Return: VIDOUT_SCALE-<mode></p> <p>Description: Set the Scaling Mode on the Receiver.</p> <p>Variables: mode = AUTO, MANUAL, BYPASS</p>	<p>Command: SEND_COMMAND VIDEO_OUTPUT_1,""VIDOUT_SCALE-AUTO""</p> <p>Return: VIDOUT_SCALE-AUTO</p> <p>Description: Set scaler mode to auto.</p>
10	?VIDOUT_SCALE	<p>Command: SEND_COMMAND <DEV>,""?VIDOUT_SCALE""</p> <p>Return: VIDOUT_SCALE-<mode></p> <p>Description: Request the current Scaling Mode that the Receiver is set to.</p> <p>Variables: mode = AUTO, MANUAL, BYPASS</p>	<p>Command: SEND_COMMAND VIDEO_OUTPUT_1,""?VIDOUT_SCALE""</p> <p>Return: VIDOUT_SCALE-AUTO</p> <p>Description: Scaler mode is auto.</p>

NO	Description	Command	Example
11	VIDOUT_RES_REF	<p>Command: SEND_COMMAND <DEV>,"VIDOUT_RES_REF- <horizontal>x<vertical>,<refresh- rate>"</p> <p>Return: VIDOUT_RES_REF- <horizontal>x<vertical>,<refresh-rate></p> <p>Description: Set the resolution and refresh rate of the video through the Receiver, and set Scalar mode to be MANUAL mode</p> <p>Variables: Variables: horizontal = An integer value representing the horizontal. vertical = An integer value representing the vertical. May have an additional qualifier such as 'i' or 'p'. refresh-rate = An integer value representing the refresh rate.</p> <pre>{ 4096x2160,60 4096x2160,30 4096x2160,25 4096x2160,24 3840x2160,60 3840x2160,50 3840x2160,30 3840x2160,25 3840x2160,24 1920x1200,60 1920x1080,60 (Default when Scalar is Manual Mode) 1920x1080,50 1280x720,60 1280x720,50 1680x1050,60 1600x1200,60 1600x900,60 1440x900,60 1366x768,60 1360x768,60 1280x1024,60 1280x960,60 1280x800,60 1280x768,60 1024x768,60 800x600,60 }</pre>	<p>Command: SEND_COMMAND VIDEO_OUTPUT_1,"VIDOUT_RES_REF- 3840x2160,60"</p> <p>Return: VIDOUT_RES_REF-3840x2160,60</p> <p>Description: HDMI out resolution is 3840x2160@60.</p>

NO	Description	Command	Example
12	?VIDOUT_RES_REF	<p>Command: SEND_COMMAND <DEV>,""?VIDOUT_RES_REF"</p> <p>Return: VIDOUT_RES_REF- <horizontal>x<vertical>,<refresh-rate></p> <p>Description: Request the resolution and refresh rate of the video through the Receiver.</p> <p>Variables: <horizontal>x<vertical>,<refresh-rate> { 4096x2160,60 4096x2160,30 1024x768,60 800x600,60 }</p>	<p>Command: SEND_COMMAND VIDEO_OUTPUT_1,""?VIDOUT_RES_REF"</p> <p>Return: VIDOUT_RES_REF-3840x2160,60</p> <p>Description: HDMI out resolution is 3840x2160@60.</p>
13	?VIDOUT_RES	<p>Command: SEND_COMMAND <DEV>,""?VIDOUT_RES"</p> <p>Return: VIDOUT_RES- <horizontal>x<vertical>,<refresh-rate></p> <p>Description: Request the resolution and refresh rate of the video through the Receiver.</p> <p>Variables: <horizontal>x<vertical>,<refresh-rate> { 4096x2160,60 4096x2160,30 1024x768,60 800x600,60 }</p>	<p>Command: SEND_COMMAND VIDEO_OUTPUT_1,""?VIDOUT_RES"</p> <p>Return: VIDOUT_RES-3840x2160,60</p> <p>Description: HDMI out resolution is 3840x2160@60.</p>
14	VIDOUT_COLOR_SPACE	<p>Command: SEND_COMMAND <DEV>,""VIDOUT_COLOR_SPACE-<format>"</p> <p>Return: VIDOUT_COLOR_SPACE-<format></p> <p>Description: Set the scaler output color space for receiver.</p> <p>Variables: format = { RGB (Default)</p>	<p>Command: SEND_COMMAND dvRX,""VIDOUT_COLOR_SAPCE-YUV444"</p> <p>Return: VIDOUT_COLOR_SPACE-YUV444</p> <p>Description: Set scaler output color space to be YUV444 for receiver.</p>

NO	Description	Command	Example
		YUV444 }	
15	?VIDOUT_COLOR_SPACE	<p>Command: SEND_COMMAND <DEV>,""?VIDOUT_COLOR_SPACE"</p> <p>Return: VIDOUT_COLOR_SPACE-<format></p> <p>Description: Request the scaler output color space for receiver.</p> <p>Variables: format = { RGB (Default) YUV444 }</p>	<p>Command: SEND_COMMAND dvRX,""?VIDOUT_COLOR_SAPCE"</p> <p>Return: VIDOUT_COLOR_SPACE-RGB</p> <p>Description: The scaler output color space is RGB.</p>
16	?VIDOUT_EDID_DATA	<p>Command: SEND_COMMAND <DEV>,""?VIDOUT_EDID_DATA"</p> <p>Return: VIDOUT_EDID_DATA-<edid></p> <p>Description: Download current Active EDID in Receiver</p> <p>Note: it can be EDID under Scalar AUTO/Manual Mode, and EDID under Bypass mode</p> <p>Variables: edid = 256byte EDID in HEX value</p>	<p>Command: SEND_COMMAND dvRX,""?VIDOUT_EDID_DATA</p> <p>Return: VIDOUT_EDID_DATA-00 FF FF FF FF FF FF 00 05 B8 00 11 04 00 00 00 1C 19 01 03 80 00 00 78 0E EE 95 A3 54 4C 99 26 0F 50 54 FF FF 80 D1 00 B3 00 A9 40 81 00 81 C0 81 80 8B C0 95 00 02 3A 80 18 71 38 2D 40 58 2C 45 00 40 84 63 00 00 1E 00 00 00 FC 00 41 4D 58 5F 48 44 4D 49 31 76 34 0A 20 00 00 00 FD 00 17 78 0F 66 11 00 0A 20 20 20 20 20 00 00 00 FA 00 D1 C0 A9 C0 90 40 81 40 01 01 01 01 0A 01 5F 02 03 30 70 67 03 0C 00 11 00 80 22 5F 10 20 22 1F 21 05 14 04 03 13 02 0E 0F 11 06 07 12 15 16 1D 1E 27 29 2A 2B 2C 2D 2F 30 31 01 23 09 07 07 1A 36 80 A0 70 38 1F 40 30 20 35 00 40 84 63 00 00 1A 46 37 80 70 72 38 22 40 70 C8 35 00 40 84 63 00 00 1C D1 3D 80 80 72 B0 26 40 78 C8 36 00 40 E8 63 00 00 1C 28 3C 80 A0 70 B0 23 40 30 20 36 00 40 E8 63 00 00 1A 00 00 00 00 00 00 45</p> <p>Description: Download current active EDID in Receiver.</p>
17	VIDOUT_MUTE	<p>Command: SEND_COMMAND <DEV>,""?VIDOUT_MUTE-<ENABLE DISABLE>"</p> <p>Return: VIDOUT_MUTE<ENABLE DISABLE></p> <p>Description: Set the Mute preference of the image from the Receiver.</p>	<p>Command: SEND_COMMAND SWITCHER,""?VIDOUT_MUTE-ENABLE"</p> <p>Return: VIDOUT_MUTE-ENABLE</p> <p>Description: Set Video mute mode to enable</p>

NO	Description	Command	Example
18	?VIDOUT_MUTE	<p>Command: SEND_COMMAND <DEV>,""?VIDOUT_MUTE"</p> <p>Return: VIDOUT_MUTE<ENABLE DISABLE></p> <p>Description: Request the setting for the Mute preference applied to the image from the Receiver.</p>	<p>Command: SEND_COMMAND SWITCHER,""?VIDOUT_MUTE"</p> <p>Return: VIDOUT_MUTE-DISABLE</p> <p>Description: Video mute mode is disable</p>
19	VIDOUT_FREEZE	<p>Command: SEND_COMMAND <DEV>,""?VIDOUT_MUTE-<ON OFF>"</p> <p>Return: VIDOUT_MUTE<ENABLE DISABLE></p> <p>Description: Set the freeze setting on the specified video output port (if enabled, freeze setting is ON, if disabled, freeze setting is OFF)</p>	<p>Command: SEND_COMMAND SWITCHER,""?VIDOUT_FREEZE-ENABLE"</p> <p>Return: VIDOUT_FREEZE-ENABLE</p> <p>Description: Set Video FREEZE to EANBLE.</p>
20	?VIDOUT_FREEZE	<p>Command: SEND_COMMAND <DEV>,""?VIDOUT_FREEZE"</p> <p>Return: VIDOUT_FREEZE<ON OFF></p> <p>Description: Request the status of the freeze option of the specified video output port</p>	<p>Command: SEND_COMMAND SWITCHER,""?VIDOUT_FREEZE"</p> <p>Return: VIDOUT_FREEZE-DISABLE</p> <p>Description: Video FREEZE setting is disable.</p>
21	VIDOUT_SLEEP	<p>Command: SEND_COMMAND <DEV>,""?VIDOUT_SLEEP-<ENABLE DISABLE>"</p> <p>Return: VIDOUT_SLEEP<ENABLE DISABLE></p> <p>Description: Set the TMDS clock behavior when no output signal on HDMI out.</p>	<p>Command: SEND_COMMAND SWITCHER,""?VIDOUT_SLEEP-ENABLE"</p> <p>Return: VIDOUT_SLEEP-ENABLE</p> <p>Description: Set HDMI TMDS sleep to be enabled when no output signal.</p>
22	?VIDOUT_SLEEP	<p>Command: SEND_COMMAND <DEV>,""?VIDOUT_SLEEP"</p> <p>Return: VIDOUT_SLEEP-<ENABLE DISABLE></p> <p>Description: Request to see the TMDS sleep has been enabled or disabled.</p>	<p>Command: SEND_COMMAND dvRX,""?VIDOUT_SLEEP"</p> <p>Return: VIDOUT_SLEEP-DISABLE</p> <p>Description: HDMI TMDS sleep setting is disable when no output signal.</p>

NO	Description	Command	Example
23	VIDOUT_SLEEP_DELAY	<p>Command: SEND_COMMAND <DEV>,"VIDOUT_SLEEP_DELAY- <timer>"</p> <p>Return: VIDOUT_SLEEP_DELAY-<timer></p> <p>Description: Set the TMDS clock behavior when no output signal on HDMI out.</p> <p>Variables: timer = [0...32737] (Default =30)</p>	<p>Command: SEND_COMMAND SWITCHER,"VIDOUT_SLEEP_DELAY-60"</p> <p>Return: VIDOUT_SLEEP_DELAY-60</p> <p>Description: Set HDMI TMDS sleep delay to be 60 when no output signal.</p>
24	?VIDOUT_SLEEP_DELAY	<p>Command: SEND_COMMAND <DEV>, "?VIDOUT_SLEEP_DELAY"</p> <p>Return: VIDOUT_SLEEP-<timer></p> <p>Description: Request the delay prior to turning off TMDS clock when no input signal received.</p> <p>Variables: timer = [0...32737] (Default =30)</p>	<p>Command: SEND_COMMAND dvRX,"?VIDOUT_SLEEP_DELAY"</p> <p>Return: VIDOUT_SLEEP_DELAY-60</p> <p>Description: HDMI TMDS sleep delay setting is 60 when no output signal.</p>
25	VIDOUT_BRIGHTNESS	<p>Command: SEND_COMMAND <DEV>,"VIDOUT_BRIGHTNESS- <value>"</p> <p>Return: VIDOUT_BRIGHTNESS-<value></p> <p>Description: Set the brightness setting on the specified video output port.</p> <p>Variables: value = [0...100], default = 50 and 50 is bypass for video input brightness</p>	<p>Command: SEND_COMMAND dvRX,"VIDOUT_BRIGHTNESS-75"</p> <p>Return: VIDOUT_BRIGHTNESS-75</p> <p>Description: Set Video Brightness to 75.</p>
26	?VIDOUT_BRIGHTNESS	<p>Command: SEND_COMMAND <DEV>, "?VIDOUT_BRIGHTNESS"</p> <p>Return: VIDOUT_BRIGHTNESS-<value></p> <p>Description: Request the status of the brightness option of the specified video output port.</p> <p>Variables: value = [0...100]</p>	<p>Command: SEND_COMMAND dvRX,"?VIDOUT_BRIGHTNESS"</p> <p>Return: VIDOUT_BRIGHTNESS-75</p> <p>Description: Video Brightness setting is 75.</p>

NO	Description	Command	Example
27	VIDOUT_CONTRAST	<p>Command: SEND_COMMAND <DEV>,"VIDOUT_CONTRAST-<value>"</p> <p>Return: VIDOUT_CONTRAST-<value></p> <p>Description: Set the contrast setting on the specified video output port.</p> <p>Variables: value = [0...100], default = 50 and 50 is bypass for video input contrast</p>	<p>Command: SEND_COMMAND dvRX,"VIDOUT_CONCTRST-75"</p> <p>Return: VIDOUT_CONTRAST-75</p> <p>Description: Set Video Contrast to 75.</p>
28	?VIDOUT_CONTRAST	<p>Command: SEND_COMMAND <DEV>, ""?VIDOUT_CONTRAST"</p> <p>Return: VIDOUT_CONTRAST-<value></p> <p>Description: Request the status of the contrast option of the specified video output port</p> <p>Variables: value = [0...100]</p>	<p>Command: SEND_COMMAND dvRX, ""?VIDOUT_CONTRAST"</p> <p>Return: VIDOUT_CONTRAST-75</p> <p>Description: Video Contrast setting is 75.</p>
29	VIDOUT_OSD	<p>Command: SEND_COMMAND <DEV>,"VIDOUT_OSD- <ENABLE DISABLE>"</p> <p>Return: VIDOUT_OSD-<ENABLE DISABLE></p> <p>Description: Enable or Disable the On-Screen Display (OSD) setting on specified video port. If enabled, OSD setting is on. If disabled, OSD setting is off.</p>	<p>Command: SEND_COMMAND dvRX,"VIDOUT_OSD- ENABLE"</p> <p>Return: VIDOUT_OSD-ENABLE</p> <p>Description: Set OSD on video output port to be Enabled.</p>
30	?VIDOUT_OSD	<p>Command: SEND_COMMAND <DEV>, ""?VIDOUT_OSD"</p> <p>Return: VIDOUT_OSD-<ENABLE DISABLE></p> <p>Description: Request whether the specified video port has the OSD setting enabled or disabled.</p>	<p>Command: SEND_COMMAND dvRX, ""?VIDOUT_OSD"</p> <p>Return: VIDOUT_OSD-ENABLE</p> <p>Description: OSD on video output port is Enable.</p>

NO	Description	Command	Example
31	VIDOUT_OSD_COLOR	<p>Command: SEND_COMMAND <DEV>, ""?VIDOUT_OSD_COLOR-<color>""</p> <p>Return: VIDOUT_OSD_COLOR-<color></p> <p>Description: Set the On-Screen Display (OSD) color scheme on the display connected to the specified video port.</p> <p>Variables: color = { BLACK (black background, white font) BLUE (blue background, yellow font) WHITE (white background, black font) YELLOW (yellow background, blue font) }</p>	<p>Command: SEND_COMMAND dvRX ,""?VIDOUT_OSD_COLOR-BLACK""</p> <p>Return: VIDOUT_OSD_COLOR-BLACK</p> <p>Description: Set OSD Color on video output port to BLACK</p>
32	?VIDOUT_OSD_COLOR	<p>Command: SEND_COMMAND <DEV>, ""?VIDOUT_OSD_COLOR""</p> <p>Return: VIDOUT_OSD_COLOR-<color></p> <p>Description: Request the On-Screen Display (OSD) color on the display connected to the specified video port.</p> <p>Variables: color = { BLACK (black background, white font) BLUE (blue background, yellow font) WHITE (white background, black font) YELLOW (yellow background, blue font) }</p>	<p>Command: SEND_COMMAND dvRX ,""?VIDOUT_OSD_COLOR""</p> <p>Return: VIDOUT_OSD_COLOR-BLACK</p> <p>Description: OSD Color on video output port is BLACK.</p>
33	VIDOUT_OSD_POS	<p>Command: SEND_COMMAND <DEV>, ""?VIDOUT_OSD_POS-<position>""</p> <p>Return: VIDOUT_OSD_POS-<position></p> <p>Description: Set the On-Screen Display (OSD) position on the display connected to the specified video port.</p> <p>Variables: position = { TOP LEFT (default) TOP RIGHT BTM RIGHT</p>	<p>Command: SEND_COMMAND dvRX ,""?VIDOUT_OSD_POS-TOP RIGHT""</p> <p>Return: VIDOUT_OSD_POS-TOP RIGHT</p> <p>Description: Set OSD position on video output port to TOP RIGHT</p>

NO	Description	Command	Example
		BTM LEFT }	
34	?VIDOUT_OSD_POS	<p>Command: SEND_COMMAND <DEV>, ""?VIDOUT_OSD_POS""</p> <p>Return: VIDOUT_OSD_POS-<position></p> <p>Description: Request the On-Screen Display (OSD) position on the display connected to the specified video port.</p> <p>Variables: position = { TOP LEFT (default) TOP RIGHT BTM RIGHT BTM LEFT }</p>	<p>Command: SEND_COMMAND dvRX ,""?VIDOUT_OSD_POS""</p> <p>Return: VIDOUT_OSD_POS-TOP RIGHT</p> <p>Description: OSD position on video output port is TOP RIGHT</p>
35	VIDOUT_HDCP	<p>Command: SEND_COMMAND <DEV>,""VIDOUT_HDCP-<mode>""</p> <p>Return: VIDOUT_HDCP-<mode></p> <p>Description: Set HDCP compliance of the specified video output port.</p> <p>Variables: mode = { FOLLOW (Default) HDCP2.2, HDCP1.4, NO HDCP }</p>	<p>Command: SEND_COMMAND VIDEO_INPUT_1,""VIDOUT_HDCP-NO HDCP""</p> <p>Return: VIDOUT_HDCP-NO HDCP</p> <p>Description: Only when input is not HDCP encrypted, the output will display normally, otherwise it is black screen.</p>

NO	Description	Command	Example
36	?VIDOUT_HDCP	<p>Command: SEND_COMMAND <DEV>,""?VIDOUT_HDCP"</p> <p>Return: VIDOUT_HDCP-<mode></p> <p>Description: Get HDCP compliance setting of the specified video output port.</p> <p>Variables: mode = { FOLLOW (Default) HDCP2.2, HDCP1.4, NO HDCP }</p>	<p>Command: SEND_COMMAND VIDEO_INPUT_1,""?VIDOUT_HDCP"</p> <p>Return: VIDOUT_HDCP-FOLLOW</p> <p>Description: Video output with HDCP encryption following sink display. (NOTE: There is one exception, if sink display is Non-HDCP compliance, works as HDCP repeater, as it is illegal to remove HDCP for Non-HDCP compliance sink device)</p>

NO	Description	Command	Example
CEC SEND_COMMANDs are sent to Port 6			
37	VIDOUT_CEC_POWER	<p>Command: SEND_COMMAND <DEV>,"VIDOUT_CEC_POWER- <ON OFF>"</p> <p>Return: VIDOUT_CEC_POWER-<ON OFF></p> <p>Description: Set power status to on/off on the sink display.</p>	<p>Command: SEND_COMMAND <DEV>,"VIDOUT_CEC_POWER-OFF"</p> <p>Return: VIDOUT_CEC_POWER-OFF</p> <p>Description: Set power status to OFF on sink display.</p>
38	?VIDOUT_CEC_POWER	<p>Command: SEND_COMMAND <DEV>,"?VIDOUT_CEC_POWER"</p> <p>Return: VIDOUT_CEC_POWER-<state></p> <p>Description: Request the current power status from the TV via CEC.</p> <p>Variables: state = { ON, OFF, WARMUP, COOLDOWN }</p>	<p>Command: SEND_COMMAND <DEV>,"?VIDOUT_CEC_POWER"</p> <p>Return: VIDOUT_CEC_POWER-OFF</p> <p>Description: Current power status from sink TV is power off.</p>
39	VIDOUT_CEC_SYS_STANDBY	<p>Command: SEND_COMMAND <DEV>,"VIDOUT_CEC_SYS_STANDBY"</p> <p>Return: VIDOUT_CEC_SYS_STANDBY</p> <p>Description: Set all devices connected to the HDMI output go to Standby mode.</p>	<p>Command: SEND_COMMAND <DEV>,"VIDOUT_CEC_SYS_STANDBY"</p> <p>Return: VIDOUT_CEC_SYS_STANDBY</p> <p>Description: Set all devices connected to the HDMI output to Standby mode.</p>
40	VIDOUT_CEC_MAKEACTIVE	<p>Command: SEND_COMMAND <DEV>,"VIDOUT_CEC_MAKEACTIVE"</p> <p>Return: VIDOUT_CEC_MAKEACTIVE</p> <p>Description: Set sink TV to turn on and make HDMI to be connected to the active source.</p>	<p>Command: SEND_COMMAND <DEV>,"VIDOUT_CEC_MAKEACTIVE"</p> <p>Return: VIDOUT_CEC_MAKEACTIVE</p> <p>Description: Set sink TV to turn on and make HDMI to be connected to the active source.</p>

NO	Description	Command	Example
41	CEC_DISP_AUTO	<p>Command: SEND_COMMAND <DEV>,"CEC_DISP_AUTO-<ON OFF>"</p> <p>Return: 'CEC_DISP_AUTO-<ON OFF></p> <p>Description: Set power control of sink display automatically according to detect active input signal and its own power boot-up state.</p>	<p>Command: SEND_COMMAND <DEV>,"CEC_DISP_AUTO-OFF"</p> <p>Return: CEC_DISP_AUTO-OFF</p> <p>Description: Set the function to OFF for power control of sink display automatically.</p>
42	?CEC_DISP_AUTO	<p>Command: SEND_COMMAND <DEV>,""?CEC_DISP_AUTO"</p> <p>Return: CEC_DISP_AUTO-<ON OFF></p> <p>Description: Get the configuration for power control of sink display automatically.</p>	<p>Command: SEND_COMMAND dvRX,""?CEC_DISP_AUTO"</p> <p>Return: CEC_DISP_AUTO-ON</p> <p>Description: The configuration for power control of sink display automatically is ON.</p>
43	CEC_SLEEP_TIMEOUT	<p>Command: SEND_COMMAND <DEV>,"CEC_SLEEP_TIMEOUT-<time>"</p> <p>Return: CEC_SLEEP_TIMEOUT-<time></p> <p>Description: Set Delay Time to control sink display power automatically</p> <p>Variables: time: {1 ~ 30} minutes</p>	<p>Command: SEND_COMMAND dvRX,"CEC_SLEEP_TIMEOUT-5"</p> <p>Return: CEC_SLEEP_TIMEOUT-5</p> <p>Description: Set Delay Time to 5 Minutes</p>
44	?CEC_SLEEP_TIMEOUT	<p>Command: SEND_COMMAND <DEV>,""?CEC_SLEEP_TIMEOUT"</p> <p>Return: CEC_SLEEP_TIMEOUT-<time></p> <p>Description: Get Delay Time to control sink display power on/off automatically.</p> <p>Variables: time: {1 ~ 30} minutes</p>	<p>Command: SEND_COMMAND dvRX,""?CEC_SLEEP_TIMEOUT"</p> <p>Return: CEC_SLEEP_TIMEOUT-5</p> <p>Description: The Delay Time to control sink display power on/off automatically according to detect active input signal or its own power boot-up state is 5 minutes.</p>
Audio SEND_COMMANDs are sent to Port 6			
45	AUDOUT_MUTE	<p>Command: SEND_COMMAND <DEV>,"AUDOUT_MUTE- <ENABLE DISABLE>"</p> <p>Return: AUDOUT_MUTE-<ENABLE DISABLE></p> <p>Description: Sets the Mute preference of the audio from the Receiver.</p>	<p>Command: SEND_COMMAND dxDev,"AUDOUT_MUTE-DISABLE"</p> <p>Return: AUDOUT_MUTE-DISABLE</p> <p>Description: Set Audio mute mode to disable.</p>

NO	Description	Command	Example
46	?AUDOUT_MUTE	<p>Command: SEND_COMMAND <DEV>,""?AUDOUT_MUTE"</p> <p>Return: AUDOUT_MUTE-<ENABLE DISABLE></p> <p>Description: Request the setting for the Mute preference of the audio from the Receiver.</p>	<p>Command: SEND_COMMAND dxDev, ""?AUDOUT_MUTE"</p> <p>Return: AUDOUT_MUTE-DISABLE</p> <p>Description: Audio mute mode is disable.</p>
47	AUDOUT_FORMAT	<p>Command: SEND_COMMAND <DEV>,"?AUDOUT_FORMAT-<format>"</p> <p>Return: AUDOUT_FORMAT-<format></p> <p>Description: Set the audio format on the Receiver (default is ALL).</p> <p>Variables: Valid response: format = { ALL (Default) HDMI, ANALOG }</p>	<p>Command: SEND_COMMAND dvRX,"?AUDOUT_FORMAT-ANALOG"</p> <p>Return: AUDOUT_FORMAT-ANALOG</p> <p>Description: Set output audio format to analog.</p>
48	?AUDOUT_FORMAT	<p>Command: SEND_COMMAND <DEV>,""?AUDOUT_FORMAT"</p> <p>Return: AUDOUT_FORMAT-<format></p> <p>Description: Request the audio format on the Receiver.</p> <p>Variables: Valid response: format = ALL, HDMI, ANALOG:</p>	<p>Command: SEND_COMMAND dvRX,"?AUDOUT_FORMAT"</p> <p>Return: AUDOUT_FORMAT-ANALOG</p> <p>Description: The output audio is analog format.</p>

NO	Description	Command	Example
IR SEND_COMMANDS are sent to Port 3 (IR TX port)			
	Channel	Function	
	1-255	Generate the IR or serial command assigned to that channel	
49	CAROFF	<p>Command: SEND_COMMAND <DEV>,"CAROFF"</p> <p>Return: CAROFF</p> <p>Description: Disable the IR carrier signal until a 'CARON' Send Command is received.</p>	<p>Command: SEND_COMMAND IR_1,"CAROFF"</p> <p>Return: CAROFF</p>
50	CARON	<p>Command: SEND_COMMAND <DEV>,"CARON"</p> <p>Return: CARON</p> <p>Description: Enable the IR carrier signals (default).</p>	<p>Command: SEND_COMMAND IR_1,"CARON"</p> <p>Return: CARON</p>
51	CH	<p>Command: SEND_COMMAND <DEV>,"CH',<channel number>"</p> <p>Description: Send IR pulses for the selected channel.</p> <p>Variables: Valid response: channel number = 0 to 199 channels All channels below 100 are transmitted as two digits. If the IR code for ENTER (function #21) is loaded, an Enter will follow the number. If the channel is greater than or equal to (>=) 100, then IR function 127 or 20 (whichever exists) is generated for the one hundred digit.</p>	<p>Command: SEND_COMMAND IR_1,"CH',18"</p> <p>Description: The IR port on the DXLink RX performs the following: Transmits IR signals for 1 (IR code 11). The transmit time is set with the CTON command. Waits until the time set with the CTOF command elapses. Transmits IR signals for 8 (IR code 18). Waits for the time set with the CTOF command to elapse. If the IR code for Enter (IR code 21) is programmed, the module performs the following steps: Transmits IR signals for Enter (IR code 21). Waits for the time set with the CTOF command to elapse.</p>
52	CP	<p>Command: SEND_COMMAND <DEV>,"CP',<code>"</p> <p>Description: Halt and clear all active or buffered IR commands, and then send a single IR pulse.</p> <p>Variables: Valid response: code = IR port's channel value 0 to 252 (253 to 255 reserved).</p>	<p>Command: SEND_COMMAND IR_1,"CP',2"</p>

NO	Description	Command	Example
53	CTOF	<p>Command: SEND_COMMAND <DEV>,"CTOF',<time>"</p> <p>Description: Set the duration of the Off time (no signal) between IR pulses for channel and IR function transmissions. Off time settings are stored in non-volatile memory. This command sets the delay time between pulses generated by the 'CH' or 'XCH' send commands in tenths of seconds.</p> <p>Variables: Valid response: time = 0 to 255. Given in 1/10th of a second increments. Default is 5 (0.5 seconds).</p>	<p>Command: SEND_COMMAND IR_1,"CTOF',10"</p>
54	CTON	<p>Command: SEND_COMMAND <DEV>,"CTON',<time>"</p> <p>Description Set the total time of IR pulses transmitted and is stored in nonvolatile memory. This command sets the pulse length for each pulse generated by the 'CH' or 'XCH' send commands in tenths of seconds.</p> <p>Variables: This command sets the pulse length for each pulse generated by the 'CH' (see previous page) or 'XCH' (see next page) Send Commands in tenth of a second increments. Valid response: time = 0 to 255. Given in 1/10th of a second increments. Default is 5 (0.5 seconds).</p>	<p>Command: SEND_COMMAND IR_1,"CTON',20"</p>
55	GET BAUD	<p>Command: SEND_COMMAND <DEV>,"GET BAUD"</p> <p>Description: Get the IR port's current communication parameters.</p>	<p>Command: SEND_COMMAND dvRXRS232,"GET BAUD"</p> <p>Description: The port responds with: Port <port #>, <baud>, <parity>, <data>, <stop></p>
56	GET MODE	<p>Command: SEND_COMMAND <DEV>,"GET MODE"</p> <p>Description: Poll the IR/Serial port's configuration parameters and report the active mode settings to the device requesting the information. NOTE: Works with Port 3 only.</p> <p>Variables: The port responds with: <port #> <mode>, <carrier>, <io link channel>.</p>	<p>Command: SEND_COMMAND IR_1,"GET MODE"</p> <p>Description: The system could respond with: PORT 3 IR, CARRIER, IO LINK 0</p>

NO	Description	Command	Example
57	IROFF	<p>Command: SEND_COMMAND <DEV>,"IROFF"</p> <p>Description: Halt and clear all active or buffered IR commands being output on the designated port.</p>	<p>Command: SEND_COMMAND IR_1,"IROFF"</p> <p>Description: Immediately halt and clear all IR output signals on the IR_1 port.</p>
58	SET BAUD	<p>Command: SEND_COMMAND <DEV>,"SET BAUD <baud>,<parity>,<data>,<stop>"</p> <p>Description: Set the IR port's DATA mode communication parameters.</p> <p>Only valid if the port is in Data Mode</p> <p>Variables: baud = baud rates are: 19200 (Serial only), 9600, 4800, 2400, 1200, 600 (IR only), 300 (IR only), 150 (IR only)</p> <p>parity = N (none), O (odd), E (even), M (mark), S (space).</p> <p>data = 7 or 8 data bits.</p> <p>stop = 1 and 2 stop bits.</p> <p>Note: The only valid 9-bit combination is (baud), N, 9, 1.</p>	<p>Command: SEND_COMMAND DEVICE_1,"SET BAUD 1200,N,8,1"</p>
59	SET MODE	<p>Command: SEND_COMMAND <DEV>,"SET MODE'<mode>"</p> <p>Return: SET MODE'<mode></p> <p>Description: Set the IR/Serial ports for IR or Serial-controlled devices to either IR, Serial, or Data mode.</p> <p>Variables: Valid response: mode = IR (standard IR output with carrier) SERIAL (IR without carrier and waveform inverted) DATA (1-way serial/TTL)</p>	<p>Command: SEND_COMMAND IR_1,"SET MODE IR"</p> <p>Description: Set the IR_1 port to IR mode for IR control.</p>
60	SP	<p>Command: SEND_COMMAND <DEV>,"SP',<code>"</p> <p>Description: Generate a single IR pulse. You can use the CTON to set pulse lengths and the CTOF for time Off between pulses.</p> <p>Variables: Valid response:</p>	<p>Command: SEND_COMMAND IR_1,"SP',25"</p> <p>Description: Pulse IR code 25 on IR port on RX.</p>

NO	Description	Command	Example
		code = IR code value 1 to 252 (253 to 255 reserved).	
61	XCH	<p>Command: SEND_COMMAND <DEV>,"XCH <channel>"</p> <p>Description: Transmit the selected channel IR codes in the format/pattern set by the XCHM command.</p> <p>Variables: Valid response: channel = 0 to 999.</p>	<p>Command: SEND_COMMAND IR_1,"XCH,30"</p> <p>Return: XCH 30</p>
62	XCHM	<p>Command: SEND_COMMAND <DEV>,"XCHM <extended channel mode>"</p> <p>Return: XCHM <extended channel mode></p> <p>Description: Change the IR output pattern for the 'XCH' Send Command.</p> <p>Variables: Valid response: extended channel mode = 0 to 4.</p>	<p>Command: SEND_COMMAND IR_1,"XCHM 3"</p> <p>Return: XCHM 3</p> <p>Description: Set the IR device's extended channel command to mode 3.</p>
SERIAL SEND_COMMANDs are sent to Port 1			
63	B9MOFF	<p>Command: B9MOFF</p> <p>Description: Set the port's communication parameters for stop and data bits according to the software settings on the RS-232 port. (Default)</p> <p>Variables: This command works in conjunction with the 'B9MON' command.</p> <ul style="list-style-type: none"> Disables 9-bit in 232 mode. By default, this returns the Communication settings on the serial port to the last programmed parameters. 	<p>Command: SEND_COMMAND SOMEDEVICE_1,"B9MOFF"</p> <p>Description: Set the port settings on SOMEDEVICE to match the port's configuration settings.</p>
64	B9MON	<p>Command: B9MON</p> <p>Description: Override and set the current communication settings and parameters on the RS-232 serial port to 9 data bits with one stop bit.</p>	<p>Command: SEND_COMMAND SOMEDEVICE_1,"B9MON"</p> <p>Description: Reset the SOMEDEVICE port's communication parameters to nine data bits and one stop bit.</p>

NO	Description	Command	Example
		This command works in conjunction with the 'B9MOFF' command. Enables 9-bit in 232 mode.	
65	CHARD	<p>Command: SEND_COMMAND <DEV>,"CHARD- <time>"</p> <p>Description: Set the delay time among all transmitted characters to the value specified (in 100 microsecond increments).</p> <p>Variables: Valid response: time = 0 to 10000 (1 second)</p>	<p>Command: SEND_COMMAND dvRXRS232,"CHARD- 10"</p> <p>Description: Set the delay time to 1-millisecond among all transmitted characters.</p>
66	CHARDM	<p>Command: SEND_COMMAND <DEV>,"CHARDM- <time>"</p> <p>Description: Set the delay time among all transmitted characters to the value specified (in 1 millisecond increments).</p> <p>Variables: Valid response: time = 0 to 1000 (1 second)</p>	<p>Command: SEND_COMMAND dvRXRS232,"CHARDM- 10"</p> <p>Description: Set the delay time to 10-millisecond among all transmitted characters.</p>
67	ESCSEQOFF	<p>Command: SEND_COMMAND <DEV>,"ESCSEQOFF"</p> <p>Description: Disable SEND_STRING escape sequences (Default).</p>	<p>Command: SEND_COMMAND dvRX,"ESCSEQOFF"</p> <p>Description: Disable SEND_STRING escape sequences (see the "SEND_STRING Escape Sequences" section)</p>
68	ESCSEQON	<p>Command: SEND_COMMAND <DEV>,"ESCSEQON"</p> <p>Description: Enable SEND_STRING escape sequences.</p>	<p>Command: SEND_COMMAND dvRX,"ESCSEQON"</p> <p>Description: Enable SEND_STRING escape sequences (see the "SEND_STRING Escape Sequences" section)</p>
69	GET BAUD	<p>Command: SEND_COMMAND <DEV>,"GET BAUD"</p> <p>Description: Get the RS-232 (serial) port's current communication parameters.</p>	<p>Command: SEND_COMMAND dvRXRS232,"GET BAUD"</p> <p>Description: The port responds with: Port <port >,<baud>,<parity>,<data>,<stop></p>

NO	Description	Command	Example
70	RXCLR	<p>Command: SEND_COMMAND <DEV>,"RXCLR"</p> <p>Description: Clear all characters in the receive buffer waiting to be sent to the Central Controller.</p>	<p>Command: SEND_COMMAND dvRXRS232,"RXCLR"</p> <p>Description: Clear all characters in the receive buffer waiting to be sent to the Central Controller.</p>
71	RXOFF	<p>Command: SEND_COMMAND <DEV>,"RXOFF"</p> <p>Description: Disable the transmission of incoming received characters to the Central Controller (default).</p>	<p>Command: SEND_COMMAND dvRXRS232,"RXOFF"</p> <p>Description: Disable the transmission of incoming received characters to the Central Controller.</p>
72	RXON	<p>Command: SEND_COMMAND <DEV>,"RXON"</p> <p>Description Start transmitting received characters to the Central Controller. Enables sending incoming received characters to the Central Controller.</p> <p>This command is automatically sent by the Central Controller when a 'CREATE_BUFFER' program instruction is executed.</p>	<p>Command: SEND_COMMAND dvRXRS232,"RXON"</p> <p>Description: Set the RX RS-232 port to transmit received characters to the Central Controller</p>
73	TXCLR	<p>Command: SEND_COMMAND <DEV>,"TXCLR"</p> <p>Description: Stop and clear all characters waiting in the transmit out buffer and stops transmission.</p>	<p>Command: SEND_COMMAND dvRXRS232,"TXCLR"</p> <p>Description: Stop and clear all characters waiting in the RX serial port's transmit buffer.</p>
74	SET BAUD (shown in examples) Or TSET BAUD	<p>Command: SEND_COMMAND <DEV>,"SET BAUD <baud>,<parity>,<data>,<stop>"</p> <p>Description: Use either of these commands to set the serial communication parameters.</p> <p>NOTE: DXLink Receivers only support RS-232 serial communication.</p> <p>Variables: Valid responses: baud = 115200, 76800, 57600, 38400, 19200, 9600, 4800, 2400, 1200, 600, 300, 150. parity = N (none), O (odd), E (even), M (mark), S (space) data = 7 or 8 data bits stop = 1 or 2 stop bits</p>	<p>Command: SEND_COMMAND DEVICE_1,"SET BAUD 115200,N,8,1"</p> <p>Description: Set the DEVICE_1 port's communication parameters to 115,200 baud, no parity, 8 data bits, and 1 stop bit.</p>

SEND_STRING Escape Sequences are sent to Port 1			
	<p>The DXLink Modules support several special SEND_STRING escape sequences. If any of the character combinations listed below are found anywhere within a SEND_STRING program instruction, they will be treated as a command and not the literal characters.</p> <p>Use the ESCSEQON and ESCSEQOFF NetLinX SEND_COMMANDS to control whether these are active or not. The ESCSEQON command must precede the Escape Sequences, otherwise strings will be processed normally. These commands are sent to Port 1.</p>		
75	27,17	<p>Command: SEND_COMMAND <DEV>,""27,17,<time>""</p> <p>Description: Send a break character for a specified duration to a specific device.</p> <p>Variables: time = 1 to 255 (measured in 100 microsecond increments)</p>	<p>Command: SEND_COMMAND RS232_1,""27,17,10""</p> <p>Description: Send a break character of 1 millisecond to the RS232_1 device.</p>
76	27,18,0	<p>Command: SEND_COMMAND <DEV>,""27,18,0""</p> <p>Description: Clear the ninth data bit by setting it to 0 on all character transmissions.</p> <p>Used in conjunction with the 'B9MON' command</p>	<p>Command: SEND_COMMAND RS232_1,""27,17,0""</p> <p>Description: Set the RS232_1 device's ninth data bit to 0 on all character transmissions</p>
77	27,18,1	<p>Command: SEND_COMMAND <DEV>,""27,18,1""</p> <p>Description: Sets the ninth data bit to 1 for all subsequent characters to be transmitted.</p> <p>Used in conjunction with the 'B9MON' command</p>	<p>Command: SEND_COMMAND RS232_1,""27,17,1""</p> <p>Description: Set the RS232_1 device's ninth data bit to 1 on all character transmissions</p>
78	27,19	<p>Command: SEND_COMMAND <DEV>,""27,19,<time>""</p> <p>Description: Insert a time delay before transmitting the next character.</p> <p>Variables: time = 1 to 255, (measured in 1 millisecond increments)</p>	<p>Command: SEND_COMMAND RS232_1,""27,19,10""</p> <p>Description: Insert a 10-millisecond delay before transmitting characters to the RS232_1 device.</p>

DX-TX-4K60&DX-RX-4K60 Commands

NO.	Description	Command	Example
DXLink Transmitter / Receiver SEND_COMMANDs are sent to Any port			
1	?FWVERSION	<p>Command: SEND_COMMAND <DEV>,""?FWVERSION""</p> <p>Return: FWVERSION <version-string></p> <p>Description: Request the firmware version of the device.</p>	<p>Command: SEND_COMMAND dvRX,""?FWVERSION""</p> <p>Return: FWVERSION-SCALER_V1.05 FWVERSION-MCORE_V1.4 FWVERSION-ACORE_V1.0</p>

NO.	Description	Command	Example
2	REBOOT	<p>Command: SEND_COMMAND <DEV>, "REBOOT"</p> <p>Return: REBOOT</p> <p>Description: Cause a warm reboot.</p>	<p>Command: SEND_COMMAND 5002:1:0, "REBOOT"</p> <p>Return: SEND_COMMAND 5002:1:0, "REBOOT"</p> <p>Description: Cause a warm reboot.</p>
3	LED-DIS	<p>Command: LED-DIS</p> <p>Description: Disable all LEDs to the right of the Program port. NOTE: This parameter does not get stored in non-volatile memory. LEDs are enabled by default at each power-up.</p>	<p>Command: SEND_COMMAND DEVICE_1,"LED-DIS"</p> <p>Description: Disable all LEDs to the right of the Program port on DEVICE_1.</p>
4	LED-EN	<p>Command: LED-EN</p> <p>Description: Enables all LEDs to the right of the Program port (Default).</p>	<p>Command: SEND_COMMAND DEVICE_1,"LED-EN"</p> <p>Description: Enable all LEDs to the right of the Program port on DEVICE_1.</p>
5	SET_NDX_DESC	<p>Command: SET_NDX_DESC-friendly name:location</p> <p>Description: Set Friendly name and location for NDP. NOTE: This command requires a reboot to enable new settings.</p> <p>Max of 25 characters for friendly name and max of 25 characters for location. If more than 25 characters are sent for either friendly name or location, they will be truncated to a max of 25 characters. Neither the friendly name nor the location should contain a ":" character, as that is used as a delimiter.</p>	
DXLink System SEND_COMMANDs are sent to Any port			
6	DXLINK	<p>Command: SEND_COMMAND <DEV>,"DXLINK-<EXTENDER ENDPOINT>"</p> <p>Return: DXLINK-<EXTENDER ENDPOINT></p> <p>Description: Set the RX to Extender Mode (for a standalone, direct connection from module to module) or Endpoint Mode (for use in conjunction with a switcher).</p>	<p>Command: SEND_COMMAND dvRX,"DXLINK-EXTENDER"</p> <p>Return: DXLINK-EXTENDER</p> <p>Description: Set DXLINK mode to extender for the RX/TX.</p>

NO.	Description	Command	Example
7	?DXLINK	<p>Command: SEND_COMMAND <DEV>,""?DXLINK"</p> <p>Return: DXLINK-<EXTENDER/ENDPOINT></p> <p>Description: Request the current mode for the TX or RX.</p>	<p>Command: SEND_COMMAND dvRX,""?DXLINK"</p> <p>Return: DXLINK-EXTENDER</p> <p>Description: Current DXLINK MODE is extender.</p>
8	ICSLAN	<p>Command: SEND_COMMAND <DEV>,""ICSLAN-<ENABLE DISABLE>"</p> <p>Return: ICSLAN-<ENABLE DISABLE></p> <p>Description: Set the ICS LAN connection to Enable or Disable.</p>	<p>Command: SEND_COMMAND dvRX,""ICSLAN-ENABLE"</p> <p>Return: ICSLAN-ENABLE</p> <p>Description: Set ICSLAN connection to enable.</p>
9	?ICSLAN	<p>Command: SEND_COMMAND <DEV>,""?ICSLAN"</p> <p>Return: ICSLAN-<ENABLE DISABLE></p> <p>Description: Get the ICS LAN connection state for ICSLAN port.</p>	<p>Command: SEND_COMMAND dvRX,""?ICSLAN"</p> <p>Return: ICSLAN-ENABLE</p> <p>Description: ISLAN connection is enable for ICLAN port.</p>
10	ICSLAN_VLAN	<p>Command: SEND_COMMAND <DEV>,""ICSLAN_VLAN-<tag>"</p> <p>Return: ICSLAN_VLAN-<tag></p> <p>Description: Set Vlan tag for ICS LAN port</p> <p>Variables: tag = { PUBLIC (Default) PRIVATE }</p>	<p>Command: SEND_COMMAND dvRX,""ICSLAN_VLAN-PRIVATE"</p> <p>Return: ICSLAN_VLAN-PRIVATE</p> <p>Description: ISLAN port is set to Private Vlan tag.</p>
11	?ICSLAN_VLAN	<p>Command: SEND_COMMAND <DEV>,""?ICSLAN_VLAN"</p> <p>Return: ICSLAN_VLAN-<tag></p> <p>Description: Get VLAN tag for ICSLAN port.</p> <p>Variables: tag = { PUBLIC (Default) PRIVATE }</p>	<p>Command: SEND_COMMAND dvRX,""?ICSLAN_VLAN"</p> <p>Return: ICSLAN_VLAN-PUBLIC</p> <p>Description: ISLAN port is set to Public Vlan tag.</p>

NO.	Description	Command	Example
12	PERSISTAV	<p>Command: SEND_COMMAND <DEV>,"PERSISTAV"</p> <p>Return: PERSISTAV</p> <p>Description: Used to save the Receiver's Power On Scaler settings/mode to the DGX DXLink Output Boards for DGX Configuration Software. Not required to save A/V settings to the receiver. These are automatically saved when changes are made.</p>	<p>Command: SEND_COMMAND dvRX,"PERSISTAV"</p> <p>Return: PERSISTAV</p>
13	FACTORYAV	<p>Command: SEND_COMMAND <DEV>,"FACTORYAV"</p> <p>Return: FACTORYAV</p> <p>Description: Clear the persisted settings for the Scaler mode, resolution, aspect ratio policy, and audio output type and restores them to their factory defaults. The "Power-On" Scaler mode on an Enova DGX DXLink Output Board will not get reset to default (AUTO), but will remain as whatever was last persisted.</p>	<p>Command: SEND_COMMAND dvRX,"FACTORYAV"</p> <p>Return: FACTORYAV</p> <p>Description: NOTE: A reboot is required after sending the FACTORYAV command.</p>
14	SET TELNET PORT 0	<p>Command: SEND_COMMAND <DEV>,"SET TELNET PORT 0"</p> <p>Return: SET TELNET PORT 0</p> <p>Description: Set the Telnet port to "0" (disabled state). NOTE: A reboot is required after sending the SET TELNET PORT 0 command.</p>	<p>Command: SEND_COMMAND dvRX,"SET TELNET PORT 0"</p> <p>Return: SET TELNET PORT 0</p>
15	SET TELNET PORT 23	<p>Command: SEND_COMMAND <DEV>,"SET TELNET PORT 23"</p> <p>Return: SET TELNET PORT 23</p> <p>Description: Set the Telnet port to "23" (default port). NOTE: A reboot is required after sending the SET TELNET PORT 23 command.</p>	<p>Command: SEND_COMMAND dvRX,"SET TELNET PORT 23"</p> <p>Return: SET TELNET PORT 23</p>
16	?USBMODE	<p>Command: SEND_COMMAND <DEV>,"?USBMODE"</p> <p>Return: USBMODE-<HOST DEVICE></p> <p>Description: Get the USB Device or Host mode state for USB pass-through direction</p>	<p>Command: SEND_COMMAND dvRX,"?USBMODE"</p> <p>Return: USBMODE-HOST</p> <p>Description: USB MODE is HOST</p>

Warranty Terms and Conditions

For the following cases AMX shall charge for the service(s) claimed for the products if the product is still remediable and the warranty card becomes unenforceable or inapplicable.

1. The original serial number (specified by AMX) labeled on the product has been removed, erased, replaced, defaced or is illegible.
2. The warranty has expired.
3. The defects are caused by the fact that the product is repaired, dismantled or altered by anyone that is not from an AMX authorized service partner. The defects are caused by the fact that the product is used or handled improperly, roughly or not as instructed in the applicable User Guide.
4. The defects are caused by any force majeure including but not limited to accidents, fire, earthquake, lightning, tsunami and war.
5. The service, configuration and gifts promised by salesman only but not covered by normal contract.
6. AMX preserves the right for interpretation of these cases above and to make changes to them at any time without notice.



© 2021 Harman. All rights reserved. SmartScale, NetLinX, Enova, AMX, AV FOR AN IT WORLD, and HARMAN, and their respective logos are registered trademarks of HARMAN. Any other company or brand name referenced may be trademarks/registered trademarks of their respective companies.

AMX does not assume responsibility for errors or omissions. AMX also reserves the right to alter specifications without prior notice at any time.

The AMX Warranty and Return Policy and related documents can be viewed/downloaded at www.amx.com.

3000 RESEARCH DRIVE, RICHARDSON, TX 75082

AMX.com | 800.222.0193 | 469.624.8000 | +1.469.624.7400 | fax 469.624.7153

Last Revised:

2021-03-08